



Operating and installation instructions Oven



To avoid the risk of accidents or damage to the appliance it is **essential** to read these instructions before it is installed and used for the first time.

Contents

| | |
|---|----|
| Warning and Safety instructions | 5 |
| Caring for the environment | 14 |
| Guide to the appliance | 15 |
| Oven | 15 |
| Oven controls | 16 |
| Function selector | 17 |
| Temperature selector  | 17 |
| Clock/timer | 17 |
| Display..... | 17 |
| Sensor controls | 17 |
| Features | 18 |
| Data plate | 18 |
| Scope of delivery..... | 18 |
| Accessories supplied and available to order..... | 18 |
| Functions..... | 28 |
| Safety features | 28 |
| PerfectClean treated surfaces..... | 29 |
| Before using for the first time | 30 |
| Before using for the first time | 30 |
| Heating up the oven for the first time..... | 31 |
| Overview of functions | 32 |
| Energy saving tips | 33 |
| Operation | 35 |
| Easy to use..... | 35 |
| Pre-heating the oven | 35 |
| Clock/timer | 36 |
| Display..... | 36 |
| Symbols in the display | 36 |
| Sensor controls | 36 |
| Setting the time | 37 |
| Time display | 37 |
| At the end of the duration..... | 37 |
| Using the minute minder  | 38 |
| Setting the minute minder | 38 |
| Changing the minute minder duration..... | 39 |
| Deleting the minute minder duration | 39 |

| | |
|---|----|
| Switching cooking programmes on and off automatically | 40 |
| Setting a cooking duration | 40 |
| At the end of the cooking duration:..... | 41 |
| Setting a cooking duration and a finish time..... | 42 |
| Changing the cooking duration | 43 |
| Deleting a cooking duration | 44 |
| Deleting the end of cooking duration | 44 |
| Changing the time of day | 45 |
| Changing settings | 46 |
| Settings overview | 47 |
| Baking | 48 |
| Tips on baking..... | 48 |
| Notes on the cooking charts | 48 |
| Notes on the functions | 49 |
| Roasting | 50 |
| Tips for roasting | 50 |
| Notes on the cooking charts | 50 |
| Notes on the functions | 51 |
| Grilling | 52 |
| Tips for grilling..... | 52 |
| Notes on the cooking charts | 52 |
| Notes on the functions | 53 |
| Further applications | 54 |
| Defrost..... | 54 |
| Low temperature cooking..... | 55 |
| Frozen food/Ready meals..... | 56 |
| Heat crockery | 57 |
| Cleaning and care | 58 |
| Unsuitable cleaning agents..... | 58 |
| Removing normal soiling | 59 |
| Removing stubborn soiling (excluding the FlexiClip runners) | 60 |
| Stubborn soiling on the FlexiClip runners | 60 |
| Pyrolytic cleaning of the oven compartment..... | 61 |
| Starting Pyrolytic cleaning..... | 62 |
| To delay the start time of the pyrolytic cleaning programme | 63 |
| At the end of pyrolytic cleaning..... | 63 |
| If pyrolytic cleaning is cancelled | 64 |
| Door removal..... | 65 |
| Dismantling the door | 66 |

Contents

| | |
|--|-----------|
| Fitting the door | 70 |
| Removing the side runners with FlexiClip runners | 71 |
| Lowering the top heat/grill element..... | 72 |
| Problem solving guide | 73 |
| Service | 77 |
| Contact in case of malfunction | 77 |
| Warranty | 77 |
| Installation | 78 |
| Installation dimensions..... | 78 |
| Installation in a tall or base unit..... | 78 |
| Side view of H 22xx..... | 79 |
| Side view H 28xx, H 25xx, H 27xx | 80 |
| Connections and ventilation..... | 81 |
| Installing the oven | 82 |
| Electrical connection | 83 |
| Oven | 83 |
| Electrical connection: Other countries | 84 |
| Cooking charts | 85 |
| Batter | 85 |
| Shortcrust pastry..... | 86 |
| Yeast dough | 87 |
| Quark dough..... | 88 |
| Sponge mixture | 89 |
| Choux pastry, puff pastry, meringue..... | 90 |
| Savoury dishes | 91 |
| Beef | 92 |
| Veal..... | 93 |
| Pork | 94 |
| Lamb, game | 95 |
| Poultry, fish..... | 96 |
| Notes for test institutes | 97 |
| Test food acc. to EN 60350-1 | 97 |
| Energy efficiency class according to EN 60350-1..... | 98 |
| Data sheet for household ovens | 98 |

Warning and Safety instructions

This oven complies with all current local and national safety requirements. However, inappropriate use can lead to personal injury and damage to property.

Read the operating and installation instructions carefully before using the oven. They contain important information on safety, installation, use and maintenance. This prevents both personal injury and damage to the oven.

In accordance with standard IEC/EN 60335-1, Miele expressly and strongly advises that you read and follow the instructions in the chapter on installing the oven as well as the safety instructions and warnings.

Miele cannot be held liable for damage caused by non-compliance with these instructions.

Keep these instructions in a safe place and pass them on to any future owner.

Warning and Safety instructions

Appropriate use

- ▶ This oven is intended for domestic use and use in other similar environments.
- ▶ The oven is not intended for outdoor use.
- ▶ The oven is intended for domestic use only to bake, roast, grill, cook, defrost and dry food.
All other types of use are not permitted.
- ▶ This oven may only be used by people with reduced physical, sensory or mental capabilities or lack of experience and knowledge if they are supervised whilst using it.
They may only use it unsupervised if they have been shown how to use it in a safe manner. They must be able to recognise and understand the dangers of misuse.
- ▶ The oven compartment is equipped with special lamps to cope with particular conditions (e.g. temperature, moisture, chemical resistance, abrasion resistance and vibration). These special lamps must only be used for the purpose for which they are intended. They are not suitable for room lighting.

Safety with children

- ▶ Children under 8 years of age must be kept away from the oven unless they are constantly supervised.
- ▶ Children aged 8 and older may only use the oven without supervision if they have been shown how to use it in a safe manner. Children must be able to understand and recognise the possible dangers caused by incorrect operation.
- ▶ Children must not be allowed to clean or maintain the oven unsupervised.
- ▶ Children should be supervised in the vicinity of the oven. Never allow children to play with the oven.
- ▶ Risk of suffocation due to packaging material. Whilst playing, children may become entangled in packaging material (such as plastic wrapping) or pull it over their head, presenting the risk of suffocation. Keep packaging material away from children.
- ▶ Risk of injury caused by hot surfaces. Children's skin is far more sensitive to high temperatures than that of adults. External parts of the oven such as the door glass, control panel and the vent become quite hot. Do not let children touch the oven when it is in operation.
- ▶ Danger of injury caused by hot surfaces. Children's skin is far more sensitive to high temperatures than that of adults. The oven gets much hotter during pyrolytic cleaning than during normal use. Do not let children touch the oven during pyrolytic cleaning.
- ▶ Risk of injury from the open door. The oven door can support a maximum weight of 15 kg. Children could injure themselves on an open door. Do not let children sit on the open door, lean against it or swing on it.

Warning and Safety instructions

Technical safety



- ▶ Unauthorised installation, maintenance and repairs can cause considerable danger for the user. Installation, maintenance and repairs must only be carried out by a Miele authorised technician.
- ▶ Damage to the oven can compromise your safety. Check the oven for visible signs of damage. Do not use a damaged oven.
- ▶ Reliable and safe operation of this oven can only be assured if it has been connected to the mains electricity supply.
- ▶ The electrical safety of this oven can only be guaranteed when correctly earthed. It is most important that this basic safety requirement is fulfilled. If in doubt, the electrical installation should be checked by a qualified electrician.
- ▶ The connection data (voltage and frequency) on the data plate of the oven must match the mains electricity supply in order to avoid the risk of damage to the oven. Compare this before connecting the appliance to the mains. If in any doubt, consult a qualified electrician.
- ▶ Multi-socket adapters and extension leads do not guarantee the required safety of the appliance. Do not use these to connect the oven to the mains electricity supply.
- ▶ For safety reasons, the oven may only be used when it has been fully installed.
- ▶ The oven must not be used in a non-stationary location (e.g. on a ship).
- ▶ Risk of injury due to electric shock. Any contact with live connections or tampering with the electrical or mechanical components of the oven will endanger your safety and may lead to the oven malfunctioning.
Do not open the oven housing under any circumstances.
- ▶ While the oven is under warranty, repairs should only be undertaken by a Miele authorised service technician. Otherwise the warranty will be invalidated.

Warning and Safety instructions

- ▶ Miele can only guarantee the safety of the oven when original Miele spare parts are used. Faulty components must only be replaced by original spare parts.
- ▶ If the oven is delivered without a power connection cable, a special cable must be installed by a Miele authorised service technician (see “Installation”, “Electrical connection”).
- ▶ If the connection cable is damaged, it must be replaced with a special connection cable by a Miele authorised service technician (see “Installation”, “Electrical connection”).
- ▶ During installation, maintenance and repair work, e.g. if the oven interior lighting is faulty (see “Problem solving guide”), the oven must be completely disconnected from the household electricity supply. To ensure this, do one of the following:
 - Disconnect the mains fuse
 - Completely unscrew the screw-out fuse (in countries where this is applicable)
 - Pull out the plug (if one is present) at the wall socket To do this, pull the plug and not the mains connection cable.
- ▶ The oven requires a sufficient supply of cool air for efficient operation. Make sure that the supply of cool air is not hindered in any way (e.g. by fitting heat insulation strips in the housing unit). Furthermore, the required supply of cool air must not be excessively heated by other heat sources (e.g. solid fuel stoves).
- ▶ If the oven is built in behind a furniture front (e.g. a door), do not close the furniture door while the oven is in use. Heat and moisture can build up behind the closed furniture door. This can result in damage to the oven, housing unit and floor. Leave the furniture front/door open until the oven has cooled down completely.

Warning and Safety instructions

Correct use



- ▶ Risk of injury caused by hot surfaces. The oven gets hot during operation. You could burn yourself on the heating elements, oven compartment, accessories or food.
Wear oven gloves when placing hot food in the oven or removing it and when adjusting oven shelves, for example, in a hot oven compartment.
- ▶ Due to the high temperatures radiated, objects left near the oven could catch fire. Do not use the oven to heat up the room.
- ▶ Oils and fats can ignite if allowed to overheat. Never leave the oven unattended when cooking with oil or fats. Never attempt to put out oil or fat fires with water. Switch the oven off and extinguish the flames by leaving the door closed.
- ▶ Grilling food for excessively long cooking durations can cause it to dry out with the risk of catching fire. Do not exceed the recommended cooking durations.
- ▶ Certain foods dry out quickly and may catch fire due to high grill temperatures.
Never use grill modes to finish baking partially baked rolls or bread or to dry flowers or herbs. Instead, use the Fan plus  or Conventional heat  function.
- ▶ If using alcohol in your recipes, please be aware that high temperatures can cause the alcohol to evaporate. The vapour can catch fire on hot heating elements.
- ▶ When using residual heat to keep food warm, corrosion from high air humidity and condensation can occur in the oven. This can also cause damage to the control panel, worktop and surrounding kitchen furniture. Keep the oven on and select the lowest temperature available for the selected function. The cooling fan will then continue to run automatically.

Warning and Safety instructions

▶ Food which is stored in the oven compartment or left in it to be kept warm can dry out and the moisture released can lead to corrosion damage in the oven. Always cover food that is left in the oven to keep warm.

▶ An accumulation of heat can cause the floor of the oven to crack or flake off.

Never line the floor of the oven compartment with aluminium foil or oven liners.

If you wish to place crockery on the oven floor during cooking, or place crockery on the oven floor to heat it up, you can do so, but only with the Fan plus  or Eco Fan heat  function.

▶ The oven compartment floor can become damaged by items being pushed around on it. When placing pots, pans or crockery on the oven compartment floor, ensure that you avoid pushing them around.

▶ Risk of injury caused by steam. Pouring a cold liquid onto a hot surface creates steam, which can cause severe scalding. The sudden temperature change can also cause damage to hot enamelled surfaces. Never pour cold liquids directly onto hot enamelled surfaces.

▶ It is important that the temperature in the food being cooked is evenly distributed and sufficiently high. This can be achieved by stirring or turning the food.

▶ Plastic dishes that are not suitable for use in an oven will melt and may ignite at high temperatures, and can damage the oven. Use only plastic containers that are suitable for use in an oven. Follow the manufacturer's instructions.

▶ Heating up food in closed containers, such as tins or sealed jars, will result in an increase in pressure, which can cause them to explode. Do not heat up unopened tins or jars of food in the oven.

▶ Risk of injury from the open door. You could bang into the open door or trip over it. Avoid leaving the door open unnecessarily.

Warning and Safety instructions

▶ The door can support a maximum load of 15 kg. Do not lean or sit on an open door, or place heavy items on it. Make sure that nothing gets trapped between the door and the oven compartment. This could damage the oven.

The following applies to stainless steel surfaces:

▶ Adhesives will damage the stainless steel surface and cause it to lose its dirt-repellent protective coating. Do not use sticky notes, adhesive tape or other types of adhesive on the stainless steel surface.

▶ Magnets can cause scratches. Do not use the stainless steel surface as a magnetic notice board.

Cleaning and care

▶ Risk of injury due to electric shock. The steam from a steam cleaning appliance could reach live electrical components and cause a short circuit. Do not use a steam cleaner to clean the appliance.

▶ Scratches on the door glass can cause the glass to break. Do not use abrasive cleaners, hard sponges, brushes or sharp metal tools to clean the door glass.

▶ The side runners can be removed (see “Cleaning and care” – “Removing the side runners with FlexiClip runners”). Refit the side runners correctly.

▶ Coarse soiling in the oven compartment can cause thick smoke to develop. Coarse soiling should be removed from the oven compartment before running the pyrolytic cleaning programme.

▶ In warm, moist environments, there is a higher probability of pest infestations (such as cockroaches). Ensure the oven and the area surrounding it are always kept clean.

Damage caused by pests is not covered by the warranty.

Accessories

- ▶ Only use original Miele accessories. If other parts are used, warranty, performance and product liability claims will be invalidated.
- ▶ The Miele gourmet oven dish HUB 5000/HUB 5001 (if available) must not be inserted into shelf level 1. This will damage the floor of the oven. The lack of clearance will create an accumulation of heat which can cause the enamel to crack or flake off. Never place a Miele oven dish on the upper support of shelf level 1 either as it will not be secured by the non-tip safety notches. As a general rule, use shelf level 2.
- ▶ Remove all accessories as well as the runners and any extra accessories such as FlexiClip runners from the oven interior before starting the Pyrolytic cleaning programme.
The high temperatures needed for pyrolysis will damage them.

Caring for the environment

Disposal of the packing material

The packaging is designed to protect the appliance from damage during transportation. The packaging materials used are selected from materials which are environmentally friendly for disposal and should be recycled.

Recycling the packaging reduces the use of raw materials in the manufacturing process and also reduces the amount of waste in landfill sites.

Disposing of your old appliance

Electrical and electronic appliances often contain valuable materials. They also contain specific materials, compounds and components, which were essential for their correct function and safety. These could be hazardous to human health and to the environment if disposed of with your domestic waste or if handled incorrectly. Please do not, therefore, dispose of your old appliance with your household waste.



Please dispose of it at your local community waste collection / recycling centre for electrical and electronic appliances, or contact your dealer or Miele for advice. You are also responsible (by law, depending on country) for deleting any personal data that may be stored on the appliance being disposed of. Please ensure that your old appliance poses no risk to children while being stored prior to disposal.

Oven

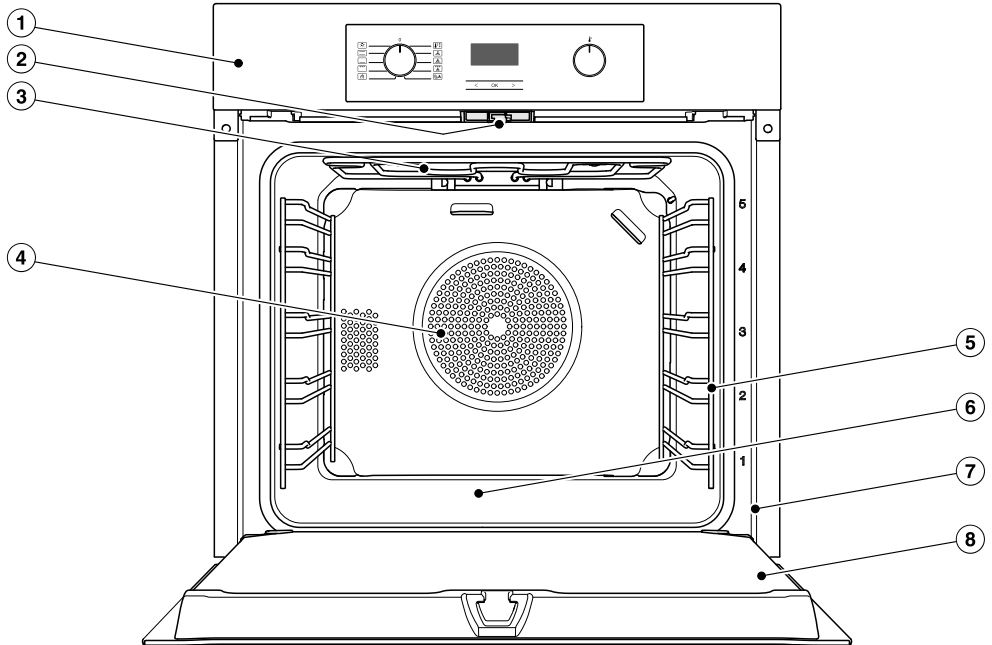

- ① Control elements
- ② Door lock for pyrolytic cleaning
- ③ Top heat/grill element
- ④ Air inlet for the fan with ring heating element behind it
- ⑤ Side runners with 5 shelf levels
- ⑥ Oven floor with bottom heat element underneath it
- ⑦ Front frame with data plate
- ⑧ Door

Oven controls

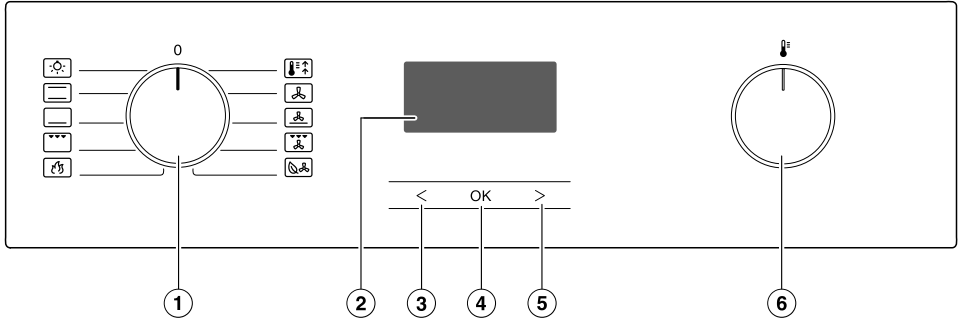

- ① Function selector
For selecting oven functions
- ② Clock/timer
For displaying the time of day and settings
- ③ Sensor control <
For modifying times and settings
- ④ OK sensor control
For selecting functions and saving settings
- ⑤ Sensor control >
For modifying times and settings
- ⑥ Temperature selector
For setting the temperature

Function selector

Use the function selector to select the required function and switch on the oven lighting independently.



It can be turned clockwise or anti-clockwise.

In the **0** position it can be retracted by pressing it in.

Functions

-  Lighting
-  Conventional heat
-  Bottom heat
-  Full grill
-  Pyrolytic
-  Booster
-  Fan plus
-  Intensive bake
-  Fan grill
-  Eco Fan heat

Temperature selector

When a function is selected, the recommended temperatures and the symbol  appear in the display. Use the temperature selector  to change the temperature for cooking processes in 5-degree increments.

The temperature selector  can be turned clockwise or anti-clockwise. It can be retracted in any position by pressing it in.

Clock/timer

The clock/timer is operated via the **display** and the **<**, **OK** and **>** **sensor controls**.

Display

The display shows the time of day or your settings.

It goes dark if settings are not being entered.

Please refer to “Clock/timer” for more information.

Sensor controls

The sensor controls respond to the touch of a fingertip. Every touch on the sensors is confirmed by an audible tone.

The tone can be switched off by changing setting *P 4* to status *5 I* (see “Clock/timer – Changing settings”).

Features

A list of the models described in these operating and installation instructions can be found on the back page of this booklet.

Data plate

The data plate is located on the front frame, visible when the door is open.

The data plate states the model number, the serial number as well as connection data (voltage, frequency and maximum rated load).

Please have this information to hand, should you need to contact Miele regarding any questions or problems.

Scope of delivery

- Operating and installation instructions for using the oven
- Screws for securing your oven in the housing unit
- Various accessories

Accessories supplied and available to order

Features will vary depending on model.

Side runners, universal tray and wire rack (or “rack” for short) are supplied as standard with the oven.

Depending on the model, your oven may also come supplied with some of the accessories listed here.

All the accessories listed as well as the cleaning and care products are designed for Miele ovens.

These are available to order via the Miele Webshop, the Miele Customer Service Department or from your Miele dealer.

When ordering, please quote the model number of your oven and the reference number of the accessories required.

Side runners

There are runners on the left and right of the oven compartment with shelves  for inserting accessories.

The numbers for the shelf levels are marked on the front frame.

Each level consists of 2 rails, one above the other.

The accessories (e.g. the rack) are pushed into the oven between the two rails.

You can remove the side runners (see “Cleaning and care” – “Removing the side runners with FlexiClip runners”).

Baking tray, universal tray and rack with non-tip notches

Baking tray HBB 71:

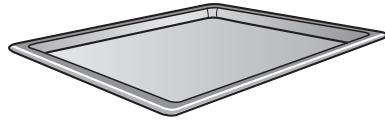

Universal tray HUBB 71:

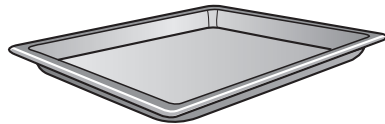

Rack HBBR 71:

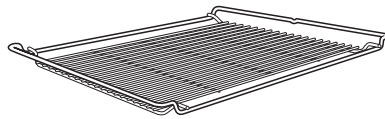

These accessories are inserted into the oven between the two rails of a shelf in the side runner.

Always place the rack with the loading surface in the lower position.

These accessories have non-tip safety notches fitted in the middle of their short sides. The non-tip safety notches prevent the trays from being pulled out completely from the side runners when you only wish to pull accessories out partially.



If you are using the universal tray with the rack on top, insert the tray between the rails of a shelf of the side runners and the rack will automatically slide in above them.

Features

FlexiClip runners HFC 70-C

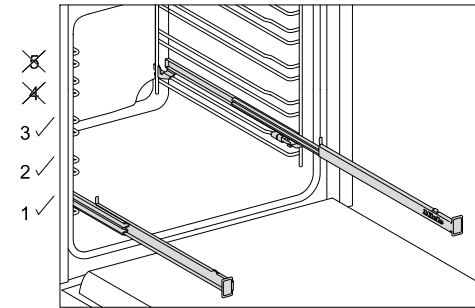

FlexiClip runners can only be fitted on levels 1, 2 and 3.

The FlexiClip runners can be drawn right out of the oven individually to give a good overview of cooking in progress.

Push the FlexiClip runners right into the oven compartment before placing accessories on them.

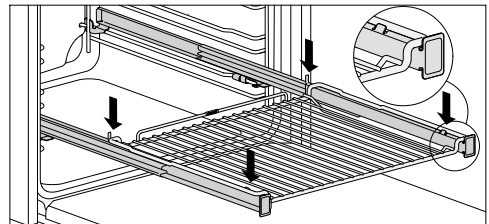
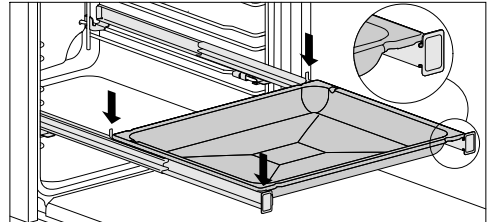

To prevent the risk of accessories sliding off the runners:

- Make sure that they are sitting securely on their runners in between the stoppers at either end of each runner.
- Always place the rack with the loading surface in the lower position on the FlexiClip runners.

The FlexiClip runners can support a maximum load of 15 kg.

Because the FlexiClip runners sit on the top rail of the side runners, the gap between the level the FlexiClip runners are on and the one above is smaller than if, for instance, racks were fitted on each level. Cooking results will be affected if the gap is too small.

You can use more than one baking tray, universal tray or rack at a time.

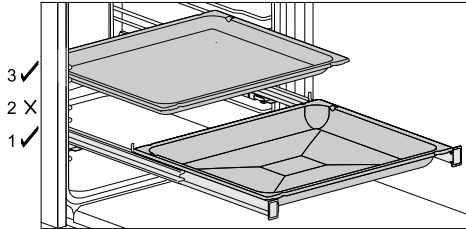

- Place the baking tray, universal tray or rack on the FlexiClip runners.
- Leave at least one shelf level free between the FlexiClip runner and any baking tray, universal tray or rack above it.

You can use the universal tray together with the rack on the FlexiClip runners.

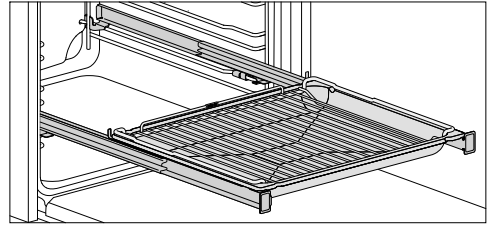

- Place the universal tray together with the rack on the FlexiClip runners. The rack will automatically slide between the rails of the shelf level above the FlexiClip runners.
- Leave at least one shelf level free between the FlexiClip runner and any baking tray, universal tray or rack above it.

Features

Fitting the FlexiClip runners

⚠ Risk of injury caused by hot surfaces.

The oven gets hot during operation. You could burn yourself on the heating elements, oven compartment or accessories.

Allow the heating elements, oven compartment and the accessories to cool before fitting or removing the FlexiClip runners.

Preferably fit the FlexiClip runners onto level 1. You can then use them for food which should be cooked on level 2.

One level of the side runners consists of two rails. The FlexiClip runners are fitted on the upper rail of the two rails that make up a shelf level.

The FlexiClip runner with the Miele logo is fitted on the right.

When fitting or removing the FlexiClip runners, **do not** extend them.

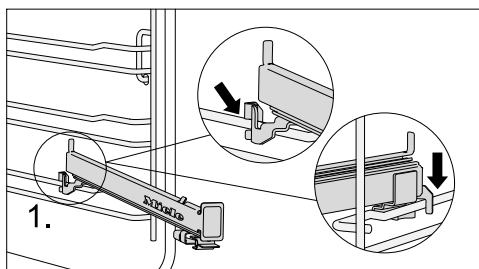

- Hook the FlexiClip runner onto the front of the top rail of a side runner (1.).

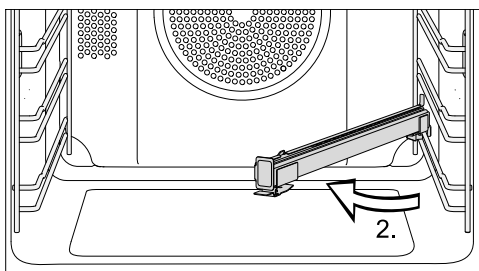

- Then hold the FlexiClip runner at an angle towards the middle of the oven compartment (2.).

Removing the FlexiClip runners

⚠ Risk of injury caused by hot surfaces.

The oven gets hot during operation. You could burn yourself on the heating elements, oven compartment or accessories.

Allow the heating elements, oven compartment and the accessories to cool before fitting or removing the FlexiClip runners.

- Push the FlexiClip runner in all the way.

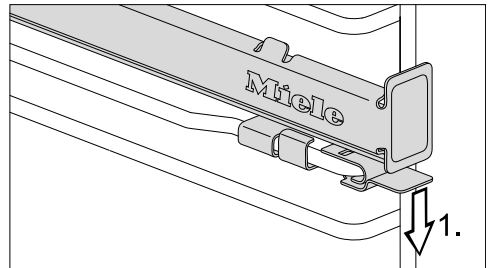

- Push down on the tab at the front of the FlexiClip runner (1.).

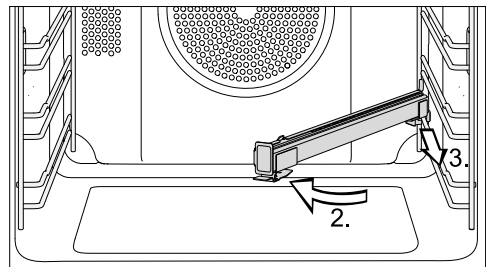

- Swing the FlexiClip runner towards the middle of the oven compartment (2.), then pull it forwards along the top rail (3.).
- Lift the FlexiClip runner off the rail and take it out of the oven.

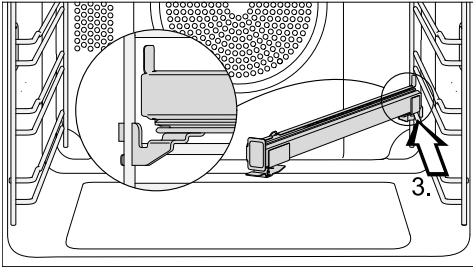

- Slide the FlexiClip runner at an angle along the top rail as far as it will go (3.).

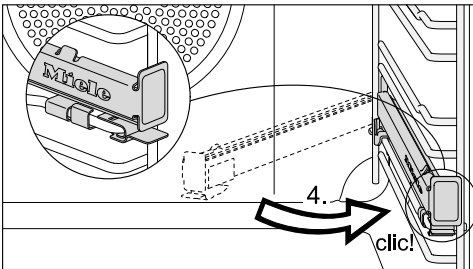

- Then swing the FlexiClip runner back to the side of the oven compartment and secure it to the top rail with an audible click (4.).

If the FlexiClip runners are difficult to pull out after fitting, you may need to pull firmly on them once to release them.

Features

FlexiClip runners HFC 7x

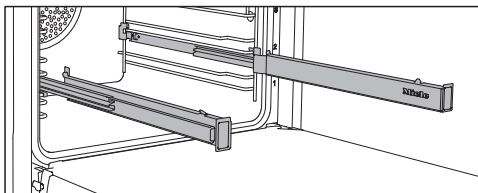

You can use the FlexiClip runners on shelf levels 1–4.

Push the FlexiClip runners right into the oven compartment before placing accessories on them.

The accessories will then automatically sit securely in between the stoppers at either end of each runner and be prevented from sliding off.

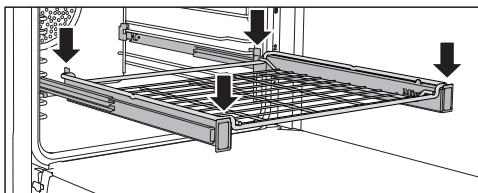
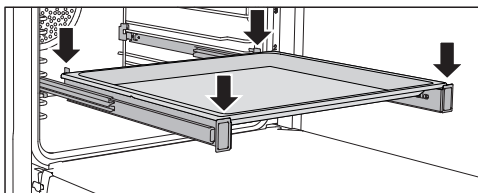

The FlexiClip runners can support a maximum load of 15 kg.

Fitting and removing FlexiClip runners

 Danger of injury caused by hot surfaces.

The oven gets hot during operation. You could burn yourself on the heating elements, oven compartment or accessories.

Allow the heating elements, oven compartment and the accessories to cool before fitting or removing the FlexiClip runners.

The FlexiClip runners are fitted in between the two rails that make up a shelf level.

The FlexiClip runner with the Miele logo should be fitted on the right.

When fitting or removing the FlexiClip runners, **do not** extend them.

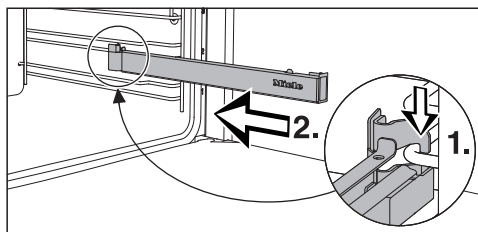

- Hook the FlexiClip runner onto the front of the lower rail of a shelf level (1.) and then push it along the rail into the oven compartment (2.).

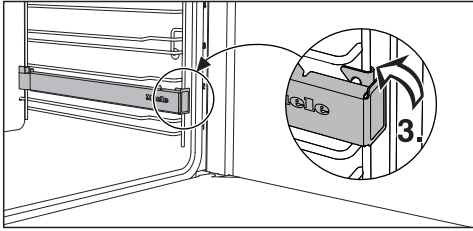

- Then secure the FlexiClip runner to the lower rail of the shelf level (3.).

If the FlexiClip runners are difficult to pull out after fitting, pull firmly on them once to release them.

To remove a FlexiClip runner, proceed as follows:

- Push the FlexiClip runner in all the way.

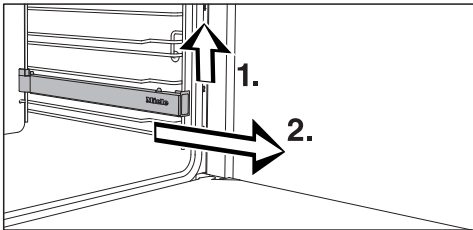

- Remove the FlexiClip runner by raising it at the front (1.) then pulling it forwards along the rail of the shelf level and out (2.).

Perforated gourmet baking tray HBBL 71

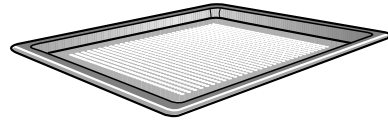

The perforated gourmet baking tray has been specially developed for the preparation of baked goods made from fresh yeast and quark doughs, as well as bread and bread rolls.

The tiny perforations assist in browning the underside of baked goods.

The gourmet baking tray can also be used for dehydrating or drying food.

The enamelled surface has been treated with PerfectClean.

The **round perforated baking tray HBFP 27-1** can be used for the same things.

Features

Round baking trays



The **solid round baking tray HBF 27-1** is suitable for cooking pizzas, flat cakes made with yeast or whisked mixtures, sweet and savoury tarts, baked desserts, flat bread, and can also be used for frozen cakes and pizzas.

The **perforated round baking tray HBFP 27-1** has been specially developed for baked goods made from fresh yeast and quark dough and for baking bread and rolls. The tiny perforations assist in browning the underside of baked goods.

The tray can also be used for dehydrating or drying food.

The enamelled surface of both baking trays has been treated with PerfectClean.

- Insert the rack and place the round baking tray on the rack.

Baking stone HBS 60

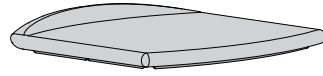

The baking stone is ideal for items which need a well baked base such as pizza, quiche, bread, bread rolls and savoury snacks.

The baking stone is made from heat-retaining fireclay and is glazed. A paddle made of untreated wood is supplied with the baking stone for placing food on it and taking it off.

- Slide the rack in and place the baking stone on it.

Grilling and roasting insert HGBB 71

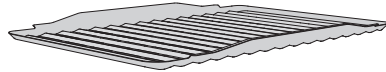

The grilling and roasting insert fits in the universal tray.

The juices from the food being grilled or roasted collect under the insert, preventing them from burning on. The juices can then be used for making gravy and sauces.

The enamelled surface has been treated with PerfectClean.

HUB gourmet oven dishes HBD gourmet oven dish lids

Unlike other oven dishes, Miele gourmet oven dishes can be placed in the oven directly on the shelf runners. They have non-tip safety notches like the rack to prevent them from being pulled out too far.

The surface of the oven dish has a non-stick coating.

Gourmet oven dishes are available in different depths. The width and the height are the same.

Suitable lids are available separately. Please quote the model number when ordering.

Depth: 22 cm

HUB 5000-M
HUB 5001-M*

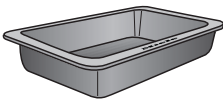

HBD 60-22

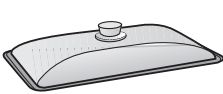

Depth: 35 cm

HUB 5001-XL*

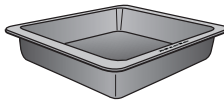

HBD 60-35

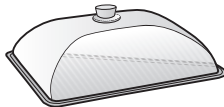

* Suitable for use on induction hobs

Handle HEG

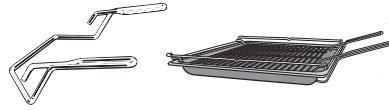

The handle makes it easier to take the universal tray, baking tray and rack out of the oven.

Accessories for cleaning and care

- Miele all-purpose microfibre cloth
- Miele oven cleaner

Features

Functions

- Using the different functions for baking, roasting and grilling
- Clock display
- Minute minder
- Switching cooking programmes on and off automatically
- Selecting custom settings

Safety features

- **System lock**  for the oven (see “Clock/timer – Changing settings”)
- **Cooling fan**
The cooling fan will come on automatically when a cooking programme is started. It ensures that the hot oven air is mixed with cool ambient air and thus cooled before it is expelled via the gap between the door and control panel.
The cooling fan will continue to run for a while after the oven has been switched off to prevent any humidity building up in the oven compartment, on the control panel or on the oven housing unit.
The cooling fan will switch itself off automatically after a certain period of time.

- **Safety switch-off**
This safety switch-off is activated automatically if the oven has been operating for an unusually long period of time. The period of time will depend on the particular oven function being used.
- **Ventilated door**
The oven door is made of glass panes that have a heat-reflective coating on part of their surface. When the oven is operating, air is passed through the door to keep the outer pane cool.
The door can be removed and disassembled for cleaning purposes (see “Cleaning and care”).
- **Door locking** for pyrolytic cleaning
At the beginning of a pyrolytic cleaning programme the door will lock for safety reasons. The door will only be unlocked when the temperature in the oven compartment has dropped to below 280 °C.

PerfectClean treated surfaces

PerfectClean surfaces have very good non-stick properties and are exceptionally easy to clean.

Food can be easily removed from these surfaces. Soiling from baking and roasting can be easily removed from these surfaces.

Food can be sliced or cut up on PerfectClean surfaces.

However, do not use ceramic knives as these will scratch the PerfectClean surface.

Surfaces treated with PerfectClean enamel can be cleaned as you would clean glass.

Read the instructions in “Cleaning and care” so that the benefits of the non-stick properties and easy cleaning are retained.

PerfectClean treated surfaces:

- Universal tray
- Baking tray
- Grilling and roasting insert
- Perforated gourmet baking tray
- Round perforated baking tray
- Round baking tray

Before using for the first time

Before using for the first time

 The oven must not be operated until it has been correctly installed in its housing unit.

- Press and release the function and temperature selectors if they are retracted.

The time of day can only be changed when the function selector is at **0**.

- Set the time of day.

Setting the time of day for the first time

The time of day is shown in the 24-hour format.



After connecting the oven to the electricity supply, *12:00* will flash on the display.

The time of day is set in segments: first the hours, then the minutes.

- Confirm with *OK*.

12:00 will light up and  will flash.

- While the  symbol is flashing, confirm with *OK*.

The hours will flash.

- Use *<* or *>* to set the hours.
- Confirm with *OK*.

The hours are saved and the minutes will flash.

- Use *<* or *>* to set the minutes.
- Confirm with *OK*.

The time of day is now saved.

The time of day can be displayed in the 12-hour format by setting *P 2* in the settings menu to status *12* (see “Clock/timer – Changing settings”).

Before using for the first time

Heating up the oven for the first time

New ovens can give off an unpleasant smell on first use. Heating up the oven for at least 1 hour with nothing in it will get rid of this smell.

Ensure that the kitchen is well ventilated during this operation. Close doors to other rooms to prevent the smell spreading throughout the house.

- Remove any stickers or protective foil from the oven and accessories.
- Take the accessories out of the oven and clean them (see “Cleaning and care”).
- Before heating the oven up, wipe the interior with a damp cloth to remove any dust or bits of packaging that may have accumulated in the oven cavity during storage and unpacking.
- Select the  Fan plus function.

The recommended temperature of 160 °C will appear. The  symbol will flash.

The oven heating, lighting and cooling fan will switch on.

- Set the maximum temperature (250 °C).
- Heat the oven for at least an hour.
- After the heating-up phase, turn the function selector to **0**.

Cleaning the oven compartment after heating it up for the first time









 Risk of injury caused by hot surfaces.

The oven gets hot during operation. You could burn yourself on the heating elements and oven compartment. Allow the heating elements and oven compartment to cool before manual cleaning.





- Clean the oven compartment with a clean sponge and a solution of hot water and washing-up liquid or a damp microfibre cloth.
- Dry all surfaces with a soft cloth.

Leave the oven door open until the oven compartment is completely dry.

Overview of functions

| Functions | Recommended value | Range |
|---|-------------------|------------|
| Fan plus  | 160 °C | 30–250 °C |
| Intensive bake  | 170 °C | 50–250 °C |
| Eco Fan heat  | 190 °C | 100–250 °C |
| Booster  | 160 °C | 100–250 °C |
| Conventional heat  | 180 °C | 30–280 °C |
| Bottom heat  | 190 °C | 100–280 °C |
| Full grill  | 240 °C | 200–300 °C |
| Fan grill  | 200 °C | 100–260 °C |
| Pyrolytic  | | |

Cooking programmes

- Remove all accessories from the oven compartment that are not required for cooking.
- In general, if a range of temperatures is given in a recipe or chart, it is best to select the lower temperature and to check the food after the shortest duration.
- Preheat the oven compartment only if instructed to do so in the recipe or the cooking chart.
- If possible, do not open the door during a programme.
- Use dark, matt bakeware and cooking containers made of non-reflective materials (enamelled steel, heat-resistant glass, coated aluminium). Shiny materials such as stainless steel or aluminium reflect the heat and therefore can give a more uneven food heating result. Do not cover the oven floor or the rack with heat-reflecting aluminium foil.
- Monitor cooking durations to avoid wasting energy when cooking. Set the cooking duration, or use a food probe if you have one.
- The Fan plus  function can be used for cooking many types of food. Because the fan distributes the heat in the oven compartment straight away, it allows you to use a lower temperature than you would with Conventional heat . It also enables you to cook on multiple shelf levels at the same time.
- Eco Fan heat  is an innovative function which is suitable for smaller foodstuffs, e.g. frozen pizzas, part-baked rolls, biscuits and for meat dishes and roasts. Energy-efficient cooking thanks to optimal utilisation of heat. When cooking on a single shelf, up to 30 % less energy is used with comparatively good cooking results. Do not open the door during the cooking programme.
- Fan grill  is the best function for grilled dishes. With this function you can use lower temperatures than in other grill functions which use the maximum temperature setting.
- Whenever possible you should cook multiple foods at the same time. Place them next to each other in the oven or on different shelf levels.
- Foods which you are unable to cook at the same time should, if possible, be cooked one after the other in order to make use of existing heat in the oven.

Energy saving tips

Residual heat utilisation

- In cooking programmes using temperatures greater than 140 °C and with cooking durations longer than 30 minutes, the temperature can be turned down to the lowest possible level about 5 minutes before the end of the cooking programme. The residual heat in the oven is sufficient for cooking the food until it is done. However, never switch the oven off (see “Warning and safety instructions”).
- It is best to start the pyrolytic cleaning programme immediately after a cooking programme. The residual heat in the oven will help reduce the amount of energy required.

Energy-saving mode

The oven will switch itself off automatically to save energy if a programme is not being run and controls have not been operated. The time of day will appear in the display or the display will remain dark (see “Clock/timer – Changing settings”).

Easy to use

- Place the food in the oven.
- Select the required oven function with the function selector.

The recommended temperature will appear.

The oven interior lighting, heating and the cooling fan will switch on.

- Use the temperature selector to change the temperature, if necessary.

The actual temperature will appear and the heating-up phase will commence.



You will see the temperature increasing. A buzzer will sound when the set temperature is reached for the first time.

- When the cooking programme is finished, turn the function selector to 0.
- Take the food out of the oven.

Pre-heating the oven

The Booster function is used to quickly pre-heat the oven.

It is only necessary to pre-heat the oven in a few instances.

- Most dishes can be placed in the cold oven to make use of the heat produced during the heating-up phase.
- Pre-heat the oven when cooking the following food with the following functions:
 - Dark bread dough as well as beef sirloin joints and fillet with the Fan plus  and Conventional heat  functions
 - Cakes and pastries with a short cooking duration (approx. 30 minutes or less) as well as delicate items (e.g. sponge) with the Conventional heat  function

Rapid heat-up

The heating-up phase can be shortened with the Booster  function.

Do not use the Booster  function to pre-heat the oven when baking pizzas or delicate mixtures (e.g. sponges, biscuits).
The food will brown too quickly on top.

- Select Booster .
- Select a temperature.
- Change to the required function after the set temperature has been reached.
- Place the food in the oven.

Clock/timer

The clock/timer offers the following functions:

- Time of day display
- Minute minder
- Switching cooking programmes on and off automatically
- Changing various settings *P*

The clock/timer is operated via the **display** and the <, *OK* and > **sensor controls**.

The functions available are indicated by symbols.

Display

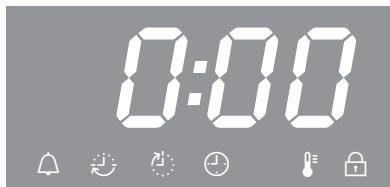

Symbols in the display

Depending on the position of the function selector \odot and/or whether a sensor control has been pressed, the following symbols appear:

| Symbol/function | \odot |
|-------------------------|----------|
| Minute minder | Any |
| Cooking duration | Function |
| End of cooking duration | |
| Temperature | |
| Time of day | 0 |
| <i>P</i> Setting | |
| 5 Setting status | |
| System lock | |

You can only set or change a function if the function selector is in the correct position.

Sensor controls

| Sensor control | Use |
|----------------|---|
| < | <ul style="list-style-type: none"> – Highlight functions – Reduce duration – Access settings <i>P</i> – Change the status 5 of a setting <i>P</i> |
| > | <ul style="list-style-type: none"> – Highlight functions – Increase duration – Change the status 5 of a setting <i>P</i> |
| <i>OK</i> | <ul style="list-style-type: none"> – Access functions – Saving set durations and changed settings – Access set durations |





Set minutes or seconds with the < or > sensor controls in increments of 1. If you hold the sensor control down the display will count down faster.

Setting the time

The time of day is set in segments:

- For the time of day and cooking durations, first the hours, then the minutes.
- For a minute minder duration, first the minutes, then the seconds.

■ Confirm with *OK*.

The respective functions appear depending on the position of the function selector (, ,  or ).

■ Highlight the function you want using the < or > sensor control.

The appropriate symbol will flash for approx. 15 seconds.

■ While the symbol is flashing, confirm with *OK*.

The function is accessed and the left-hand numeric block will flash.

You can only set the time while the numeric block is flashing. If the time has elapsed and the numeric block is no longer flashing, you have to access the function again.

■ Use the < or > sensor control to set the value you want.

■ Confirm with *OK*.



The right-hand numeric block will flash.



■ Use the < or > sensor control to set the value you want.

■ Confirm with *OK*.

The time has now been saved.

Time display

The symbols  and  or  will show if you have set times.

If you are using the minute minder , cooking duration  and end of cooking duration  functions at the same time, the last time that you set will be shown.

If you have set a cooking duration, the time of day will not be displayed.

At the end of the duration

When a duration has elapsed, the appropriate symbol will flash and a buzzer will sound if the buzzer is switched on (see “Clock/timer – Changing settings”).

■ Confirm with *OK*.

The buzzer will stop and the symbols in the display will go out.

Clock/timer

Using the minute minder

The minute minder can be used to time other activities in the kitchen, e.g. boiling eggs.

The minute minder can also be used at the same time as a cooking programme in which the start and finish times have been set, e.g. as a reminder to stir a dish or add seasoning etc.

A maximum minute minder time of 99 minutes and 59 seconds can be set.

Setting the minute minder

Example: you want to boil some eggs and set a minute minder duration of 6 minutes and 20 seconds.



- Press the < sensor control repeatedly until  starts flashing.
- Confirm with OK.



00:00 will appear and the minutes will start to flash.

If you press the < sensor control once, two dashes will appear and then when you press again the maximum possible value will appear in the minute numeric block 99.



- Use the < or > sensor control to set the minutes.
- Confirm with OK.

The minutes are saved and the seconds will flash.



- Use the < or > sensor control to set the seconds.
- Confirm with OK.



The minute minder duration is now saved and will count down in seconds.

The  symbol indicates the minute minder duration.

At the end of the minute minder duration:

- 🔔 flashes.
- The display will show the time counting upwards.
- For approx. 7 minutes, a buzzer will sound if switched on (see “Clock/timer – Changing settings”).

- Confirm with *OK*.

The buzzer will stop and the symbols in the display will go out.

If no cooking durations have been set, the time of day appears in the display.

Changing the minute minder duration

- Press the < sensor control repeatedly until 🔔 starts flashing.

The minute minder duration selected will appear.

- Confirm with *OK*.

The minutes will flash.

- Use the < or > sensor control to set the minutes.

- Confirm with *OK*.

The seconds will flash.

- Use the < or > sensor control to set the seconds.

- Confirm with *OK*.

The changed minute minder duration is now saved and will count down in seconds.

Deleting the minute minder duration

- Press the < sensor control repeatedly until 🔔 starts flashing.

- Confirm with *OK*.

The minutes will flash.

- Reduce the minutes down to *00* using the < sensor control or increase them up to *59* using the > sensor control.

The next time the sensor control is pressed two dashes will appear in place of the minutes:



- Confirm with *OK*.

Four dashes appear:





- Confirm with *OK*.

The minute minder duration is now deleted.

If no cooking durations have been set, the time of day appears in the display.

Clock/timer

Switching cooking programmes on and off automatically

Cooking programmes can be switched on or off automatically for all functions apart from Full grill  and Fan grill .

To do this, set a cooking duration or a cooking duration and finish time after selecting an oven function and a temperature.

The maximum cooking duration which can be set for a cooking programme is 11 hours and 59 minutes.

We recommend having the oven switch on and switch off automatically when roasting.

When baking, the oven should not be set to start a long time off. Otherwise the cake mixture or dough will dry out, and the raising agents will lose their effectiveness.

Setting a cooking duration

Example: a cake needs to bake for 1 hour and 5 minutes.

- Place the food in the oven.
- Select the required oven function and the temperature.

The oven heating, lighting and cooling fan will switch on.

- Press the > sensor control repeatedly until  starts flashing.

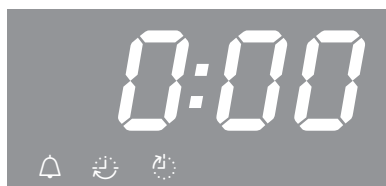

0:00 appears.

- Confirm with OK.

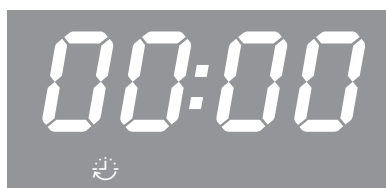

00:00 will appear and the hours will start to flash.

If you press the < sensor control once, two dashes will appear and then when you press again the maximum possible value will appear in the hour numeric block #.



- Use the < or > sensor control to set the hours.
- Confirm with OK.

The hours are saved and the minutes will flash.

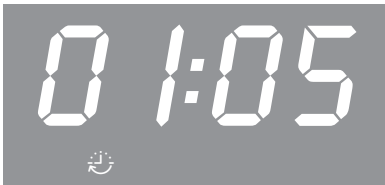

- Use the < or > sensor control to set the minutes.
- Confirm with OK.

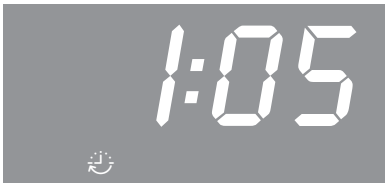

The cooking duration is now saved and will count down in minutes until the last minute, which will count down in seconds.

The 🕒 symbol indicates the cooking duration.

At the end of the cooking duration:

- 0:00 appears.
- 🕒 will flash.
- The oven heating will switch off automatically.
- The cooling fan continues to run.
- For approx. 7 minutes, a buzzer will sound if switched on (see “Clock/timer – Changing settings”).
- Confirm with OK.
- The buzzer will stop and the symbols in the display will go out.
- The time of day appears.
- The oven heating will then switch on again.
- Turn the function selector to 0.
- Take the food out of the oven.

Clock/timer

Setting a cooking duration and a finish time

To switch a cooking programme on and off automatically, you set a cooking duration and a finish time.

Example: the current time of day is 11:15; a roast with a cooking duration of 90 minutes needs to be ready at 1:30 p.m.

- Place the food in the oven.
- Select the required oven function and the temperature.

The oven heating, lighting and cooling fan will switch on.

First set the cooking duration:

- Press > repeatedly until  starts flashing.
- Confirm with OK.

00:00 will appear and the hours will start to flash.

- Use the < or > sensor control to set the hours.
- Confirm with OK.

The hours are saved and the minutes will flash.

- Use the < or > sensor control to set the minutes.
- Confirm with OK.

The cooking duration is now saved.

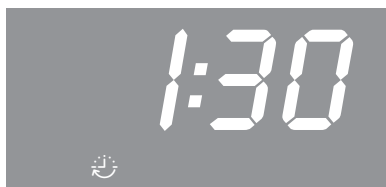

The  symbol indicates the cooking duration.

Then set the end of cooking duration:

- Press the > sensor control repeatedly until  starts flashing.



12:45 (= current time of day + cooking duration = 11:15 + 1:30) appears in the display.

- Confirm with OK.

The hours will flash.



- Use the < or > sensor control to set the hours.
- Confirm with OK.

The hours are saved and the minutes will flash.



- Use the < or > sensor control to set the minutes.
- Confirm with OK.

The end of cooking duration  is now saved.

The oven heating, lighting and cooling fan will switch off.

The selected end of cooking duration will then appear in the display.

As soon as the start time ($13:30 - 1:30 = 12:00$) has been reached, the oven heating, lighting and cooling fan will switch on.

The cooking duration set  appears and will count down in minutes until the last minute, which will count down in seconds.

Changing the cooking duration

- Press the > sensor control repeatedly until  starts flashing.

The remaining cooking duration will appear in the display.

- Confirm with OK.

The hours will flash.

- Use the < or > sensor control to set the hours.

- Confirm with OK.

The minutes will flash.

- Use the < or > sensor control to set the minutes.

- Confirm with OK.

The changed cooking duration is now saved.

Clock/timer

Deleting a cooking duration

- Press the < or > sensor control repeatedly until  starts flashing.
- Confirm with *OK*.

The hours will flash.

- Press the < or > sensor control repeatedly until two dashes appear:

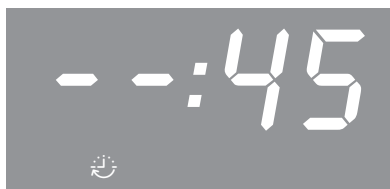

- Confirm with *OK*.

Four dashes appear:

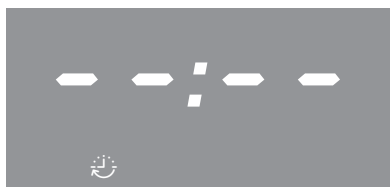

- Confirm with *OK*.

The cooking duration and any finish time will be deleted.

The time of day appears when no minute minder duration is set.

The oven heating, lighting and cooling fan will switch on.

If you want to end the cooking programme:

- Turn the function selector to **0**.
- Take the food out of the oven.

Deleting the end of cooking duration

- Press the < or > sensor control repeatedly until  starts flashing.
- Confirm with *OK*.

The hours will flash.

- Press the < or > sensor control repeatedly until two dashes appear.

- Confirm with *OK*.

Four dashes appear.

- Confirm with *OK*.

The  symbol appears and the cooking duration set will count down in minutes until the last minute, which will count down in seconds.

If you want to end the cooking programme:

- Turn the function selector to **0**.
- Take the food out of the oven.

If the function selector is turned to the **0** position, the settings for cooking duration and end of cooking duration will be deleted.

Changing the time of day

The time of day can only be changed when the function selector is at **0**.

- Turn the function selector to **0**.
- Press the > sensor control repeatedly until ⌚ starts flashing.
- Confirm with *OK*.

The hours will flash.

- Use the < or > sensor control to set the hours.
- Confirm with *OK*.

The hours are saved and the minutes will flash.

- Use the < or > sensor control to set the minutes.
- Confirm with *OK*.

The time of day is now saved.

The time of day must be reset following an interruption to the power supply.

Clock/timer

Changing settings

Default settings are set in the oven controls at the factory (see “Settings overview”).

You change a setting *P* by changing its status *S*.

- Turn the function selector to **0**.
- Press the < sensor control until *P* appears:



- If you want to change another setting, press the < or > sensor control repeatedly until the relevant number appears.
- Confirm with **OK**.



The setting is applied and the current status *S* appears, e.g. *0*

To change the status:

- Press the < or > sensor control repeatedly until the status you want is shown.
- Confirm with **OK**.

The selected status is now saved and the setting *P* appears again.

To change further settings, proceed in the same way.

If you do not want to change further settings:

- Wait approx. 15 seconds until the time of day appears.

The settings are retained in the event of an interruption to the power supply.

Settings overview

| Setting | Status | |
|--|---------------|--|
| P 1 Buzzer volume | 5 0 | The buzzer is switched off . |
| | 5 | The buzzer is switched on . |
| | 1 to 5 30* | You can adjust the volume. When you select a status, you will hear the corresponding buzzer. |
| P 2 Time of day format | 24* | The time of day is shown in a 24-hour format . |
| | 12 | The time of day is shown in the 12-hour format . If you change the clock after 1:00 p.m. from a 12-hour clock to a 24-hour clock you will need to update the hour accordingly. |
| P 3 System lock for the oven | 5 0* | The system lock is switched off . |
| | 5 1 | The system lock is switched on and  appears on the display. The system lock prevents the oven from being used unintentionally. It remains active even after an interruption to the power supply. |
| P 4 Keypad tone | 5 0 | The keypad tone is switched off . |
| | 5 1* | The keypad tone is switched on . |
| P 5 Temperature display | °C* | The temperature is displayed in degrees Celsius. |
| | °F | The temperature is displayed in degrees Fahrenheit. |

* Factory default setting

Baking

Handling food carefully will help protect your health.

Cakes, pizzas and french fries should be cooked until golden, not dark brown.

Tips on baking

- Set a cooking duration. If used for baking, do not delay the start for too long. Cake mixture or dough will dry out, and the raising agents will lose their effectiveness.
- Generally speaking, you can use racks, baking trays, universal trays and any type of baking tray made of heat-resistant material.
- Avoid using bright, thin-walled tins as they give an uneven or poor browning result. Under adverse circumstances, the food will not cook properly.
- Position rectangular tins with the longer side across the width of the oven compartment for optimum heat distribution and even baking results.
- Always place bakeware on the rack.
- Bake cakes with fruit toppings or deep cakes on the universal tray.

Using baking parchment

Miele accessories, e.g. the universal tray, are treated with PerfectClean enamel (see “Features”). Surfaces treated with PerfectClean enamel generally do not need to be greased or covered with baking parchment.

- Use baking parchment when baking lye mixtures because the sodium hydroxide used can damage the surface treated with PerfectClean.
- Use baking parchment when baking sponge, meringue, macaroons or similar items. Due to their high egg white content, these are more likely to stick.
- Use baking paper when cooking frozen food on the rack.

Notes on the cooking charts

You can find the cooking charts at the end of this book.

Selecting the temperature

- As a general rule, select the lower temperature given in the chart. Baking at temperatures higher than those recommended may reduce the cooking duration, but will lead to uneven browning of the food, and unsatisfactory cooking results.

Selecting the cooking duration

Unless otherwise stated, the cooking durations given in the cooking charts are for an oven compartment which has not been pre-heated. With a pre-heated oven compartment, shorten times by around 10 minutes.

- As a general rule, check the food after the shortest duration. Stick a wooden skewer into the food.

If it comes out clean without any batter/dough on it, the food is done.

Notes on the functions

You can find an overview of all the functions with their recommended values in “Overview of functions”.

Using Fan plus

Because the fan distributes the heat around the oven compartment straight away, it allows you to use a lower temperature than you would with the Conventional heat  function.

Use this function if you are baking on multiple shelves at the same time.

- 1 shelf: place the food in shelf level 2.
- 2 shelves: place the food on shelf levels 1+3 or 2+4.
- 3 shelves: place the food on shelf levels 1+3+5.

Tips

- If you are cooking on multiple shelves at the same time, slide the universal tray in on the lowest level.
- For moist biscuits and cakes, bake on a maximum of 2 shelf levels at once.

Using Intensive bake

Use this function for baking cakes with moist toppings.

Do **not** use this function for baking thin biscuits.

- Place cakes on shelf level 1 or 2.

Using Conventional heat

Dark metal, enamel, or aluminium bakeware with a matt finish, as well as heat-resistant glass, ceramic, and coated bakeware can be used.

Use this function for baking traditional recipes. If using an older recipe or cookbook, set the oven temperature 10 °C lower than the recommended one. This will not change the cooking duration.

- Place the food in shelf level 1 or 2.

Using Eco Fan heat

Use this function for cooking small amounts of food, e.g. frozen pizzas, part-baked rolls or biscuits, while saving energy.

- Place the food in shelf level 2.

Roasting

Tips for roasting

- You can use all crockery made from temperature-resistant materials, e.g. roasting dishes, roasting pans with lid, ovenproof glass dishes, roasting bags, dishes made from earthenware or cast iron, the universal tray, rack and/or anti-splash insert (if available) on top of the universal tray.
- **Pre-heating** the oven compartment is only required when roasting beef sirloin joints and fillet. Pre-heating is generally not necessary.
- Use a **closed roasting dish** for roasting meat, such as an oven dish. The meat stays succulent. The oven compartment will also stay cleaner than when roasting on the rack. This ensures that sufficient stock remains for making gravy.
- If you are using a **roasting bag**, follow the instructions on the packaging.
- If you are using the **rack** or an **open roasting dish** for roasting, you can add a little fat or oil to very lean meat or place a few strips of streaky bacon on the top.
- **Season** the meat and place in the roasting dish. Dot with butter or margarine or brush with oil or cooking fat if necessary. For large lean cuts of meat (2–3 kg) and fatty poultry add about 1/8 litre of water to the dish.
- Do not add too much liquid during cooking as this will hinder the **browning** process. Browning only occurs towards the end of the cooking duration. Remove the lid about halfway through the cooking duration if a more intensive browning result is desired.



- At the end of the programme, take the food out of the oven compartment, cover it and leave to **stand** for about 10 minutes. This helps retain juices when the meat is carved.
- For a crisp finish, baste **poultry** 10 minutes before the end of the cooking duration with slightly salted water.

Notes on the cooking charts

You can find the cooking charts at the end of this book.

- Take note of the temperature range, the shelf levels and the timings. These also take the type of cooking container, the size of the meat and cooking practices into account.

Selecting the temperature

- As a general rule, select the lower temperature given in the chart. If higher temperatures are used, the meat will brown on the outside, but will not be properly cooked through.
- When cooking with Fan plus , select a temperature 20 °C lower than when using Conventional heat .
- For cuts which weigh more than 3 kg, select a temperature approx. 10 °C lower than that given in the roasting chart. The roasting process will take longer, but the meat will cook evenly through and the skin or crackling will not be too thick.
- When roasting on the rack, set a temperature approx. 10 °C lower than for roasting in a covered oven dish.

Selecting the cooking duration

Unless otherwise stated, the durations given in the roasting chart are for an oven compartment which has not been pre-heated.

- The traditional British method for calculating the roasting time is to allow 15 to 20 minutes per lb/450 grammes, according to type of meat, plus approx. 20 minutes, adjusting the length of time as roasting proceeds to obtain the required result. The roasting time can also be determined by multiplying the thickness of the roast [cm] with the time per cm [min/cm] stated below, depending on the type of meat:
 - Beef/venison: 15–18 min/cm
 - Pork/veal/lamb: 12–15 min/cm
 - Sirloin/fillet: 8–10 min/cm
- As a general rule, check the food after the shortest duration.

Tips

- For frozen meat, increase the cooking duration by approx. 20 minutes per kg.
- Frozen meat weighing less than approx. 1.5 kg does not need to be defrosted before roasting.

Notes on the functions



You can find an overview of all the functions with their recommended values in “Overview of functions”.

Use the Bottom heat  function towards the end of the cooking duration to brown the base of the food.

Do not use the Intensive bake  function for roasting as the juices will become too dark.

Using Fan plus

These functions are suitable for roasting meat, fish and poultry that needs to be well browned as well as sirloin joints and fillet.

The Fan plus  function allows you to use a lower temperature than you would with the Conventional heat  function, because the heat is immediately distributed around the oven compartment.

- Place the food in shelf level 2.

Using Conventional heat

Use this function for baking traditional recipes. If using an older recipe or cookbook, set the oven temperature 10 °C lower than the recommended one. This will not change the cooking duration.

- Place the food in shelf level 2.

Using Eco Fan heat

Use this function for cooking smaller roasts or meat dishes while saving energy.

- Place the food in shelf level 2.

Grilling

 Risk of injury caused by hot surfaces.

If you grill with the door open, hot air will escape from the oven instead of being cooled by the cooling fan. The control elements will get hot.

Grill with the oven door closed.

Tips for grilling

- Pre-heating is necessary when grilling. Pre-heat the top heat/grill element for approx. 5 minutes with the door closed.
- Trim the meat if necessary. Do not season the meat with salt before grilling as this draws the juices out.
- Add a little oil to lean meat if necessary. Do not use other types of fat as they can easily burn and cause smoke.
- Clean fish in the normal way. To enhance the flavour, season with a little salt. Fish can also be drizzled with lemon juice.

- Use the universal tray with the rack or the grilling and roasting (anti-splash) insert in place. The juices collect under the insert. This prevents them from spitting and making the oven dirty and they can then be used for making gravy and sauces.

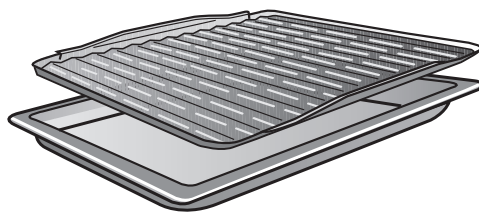
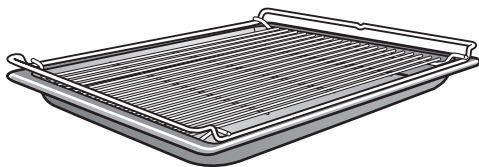

Do not use the baking tray.

- To grill, brush the rack with oil and then place the food on the rack.

Notes on the cooking charts

You can find the cooking charts at the end of this book.

- Take note of the temperature range, the shelf levels and the durations. These take the size of the meat and cooking practices into account.
- Check the food after the shortest duration quoted.

Selecting the temperature

- As a general rule, select the lower temperature given in the chart. If higher temperatures are used than

those specified, the meat will brown on the outside, but will not be properly cooked through.

Choosing a shelf level

- Select the shelf level depending on the thickness of the food to be cooked.
- Place flat food in shelf level 3 or 4.
- Place thicker food in shelf level 1 or 2.

Selecting the ⌚ cooking duration

- Grill thinner cuts of meat/slices of fish for approx. 6–8 minutes per side. It is best to grill food of a similar thickness at the same time so that the cooking durations do not vary too much.
 - As a general rule, check whether the food is cooked after the shortest duration.
 - To **test the food**, press down on the meat with a spoon. This lets you determine how well the meat has been cooked.
- **Rare/pink**
If the meat gives easily to the pressure of the spoon, it will still be red on the inside.
 - **Medium**
If there is some resistance, the inside will be pink.
 - **Well done**
If there is very little resistance, it is cooked through.

Tip: If the surface of a thicker cut of meat is browned but the centre is still raw, move the food to a lower level or reduce the temperature and continue grilling. This will stop the surface from becoming excessively charred.

Notes on the functions

You can find an overview of all the functions with their recommended values in “Overview of functions”.

Using Full grill

Use this function to grill flat thin cuts in large quantities and for browning large baked dishes.

The whole of the top heating/grill element glows red to provide the required heat.

Using Fan grill

This function is suitable for grilling thicker food, such as chicken.

A temperature setting of 220 °C is generally recommended for thinner types of food, while 180–200 °C is recommended for thicker cuts.

Further applications

This section provides information on the following applications:

- Defrost
- Low temperature cooking
- Frozen food/ready meals
- Heating crockery

Defrost

Gentle defrosting of frozen goods means that the vitamins and minerals are generally retained.

- Select Fan plus  and a temperature of 30–50 °C.

Air is circulated throughout the oven compartment to gently defrost the frozen goods.

 Risk of infection from bacteria. Bacteria such as salmonella can cause life-threatening food poisoning.

It is particularly important to observe food hygiene rules when defrosting fish and meat, and in particular when defrosting poultry.

Do not use the liquid produced during defrosting.

Process the food as required as soon as it has been defrosted.

Tips

- Remove the packaging and place the frozen goods on the universal tray or in a suitable bowl or dish.
- Use the universal tray with the rack placed on top of it for defrosting poultry. This way the frozen goods will not be lying in the defrosted liquid.
- Meat, poultry or fish does not need to be fully defrosted before cooking. Defrost until the food has started to thaw. The surface will then be sufficiently thawed to take herbs and seasoning.

Low temperature cooking

Low temperature cooking is ideal for cooking delicate cuts of beef, pork, veal or lamb when a tender result is desired.

First sear the meat all over at a high temperature on the hob in order to seal it.

Then place the meat in the pre-heated oven compartment where the low temperature and long cooking duration will cook it to perfection and ensure it is very tender.

The meat will relax. The juices inside will start to circulate evenly throughout the meat to reach the outer layers.

This gives very tender and succulent results.

- Use lean meat which has been correctly hung and trimmed. Bones must be removed before cooking.
- For searing, use a suitable cooking oil or fat that can withstand high temperatures (e.g. clarified butter, vegetable oil).
- Do not cover meat during cooking.

The cooking duration takes approx. 2–4 hours depending on the weight and size of the meat and how well you want it cooked.

- As soon as the cooking programme is done, you can carve the meat straight from the oven. It does not need to rest.
- The meat can be left in the oven compartment to keep warm until you serve it. This will not affect results in any way.

- Serve on pre-heated plates with very hot sauce or gravy to prevent it cooling down too quickly. The meat is at the ideal temperature for eating straight away.

Using Conventional heat

Follow the information in the cooking charts at the end of this book.

Use the universal tray with the rack placed on top of it.
Do not use the Booster  function to pre-heat the oven.

- Place the rack together with the universal tray on shelf level 2.
- Select the Conventional heat  function and a temperature of 120 °C.
- Pre-heat the oven together with the universal tray and rack for approx. 15 minutes.
- Whilst the oven is pre-heating, sear the meat thoroughly on all sides on the hob.

 Danger of burning due to hot surfaces.

The oven gets hot during operation. You could burn yourself on the heating elements, oven compartment or accessories.

Use oven gloves when placing hot food in the oven or removing it and when working in the hot oven compartment.

- Place the seared meat on the rack.
- Reduce the temperature to 100 °C (see “Cooking charts”).
- Continue cooking the meat until it is done.

Further applications

Frozen food/Ready meals

Tips for cakes, pizza and baguettes

- Bake cakes, pizza and baguettes on baking paper on the rack.
Do not use the baking tray or the universal tray for frozen foods with a large surface area. The tray could become warped and difficult, or even impossible, to remove from the oven compartment when hot. Additional use will make the warping worse.
- Use the lowest temperature recommended on the packaging.

Tips for French fries, croquettes and similar items

- These frozen items can be cooked on the baking tray or universal tray.
Place baking parchment on the tray so that they cook gently.
- Use the lowest temperature recommended on the packaging.
- Turn food several times during cooking.

Preparing frozen food/ready meals

Handling food carefully will help protect your health.

Cakes, pizzas and french fries should be cooked until golden, not dark brown.

- Select the function and temperature recommended on the packaging.
- Pre-heat the oven compartment.
- Place the food in the pre-heated oven compartment on the shelf level recommended on the packaging.
- Check the food at the end of the shortest cooking duration recommended on the packaging.

Heat crockery

Use the Fan plus  function for pre-heating crockery.

Only pre-heat heat-resistant crockery.

- Place the rack on shelf level 1 and place the crockery to be pre-heated on it. Depending on the size of the crockery, you can also place the rack on the oven floor and take the side runners out to make more room.
- Select Fan plus .
- Set the temperature to 50–80 °C.



Danger of burning!

Use oven gloves when removing the crockery from the oven. Droplets of water may have accumulated underneath the crockery.

- Remove the heated crockery from the oven.

Cleaning and care

 Danger of injury caused by hot surfaces.

The oven gets hot during operation. You could burn yourself on the heating elements, oven compartment or accessories.

Allow the heating elements, oven compartment and the accessories to cool before manual cleaning.

 Risk of injury due to electric shock.

The steam from a steam cleaning appliance could reach live electrical components and cause a short circuit.

Never use a steam cleaner for cleaning.

Surfaces can discolour or alter if unsuitable cleaning agents are used. The oven front is particularly susceptible to damage from oven cleaners or descaling agents.

All surfaces are susceptible to scratching. Scratches on glass can in some circumstances lead to breakage.

Remove all cleaning agent residues immediately.

Unsuitable cleaning agents

To avoid damaging the surfaces, do not use:

- cleaning agents containing soda, ammonia, acids or chlorides
- cleaning agents containing descaling agents on the front
- abrasive cleaning agents (e.g. powder cleaners, scouring milk, scouring pads)
- solvent-based cleaning agents
- stainless-steel cleaning agents
- dishwasher cleaner
- glass cleaning agents
- cleaning agents for ceramic glass hobs
- hard, abrasive brushes or sponges (e.g. pot scourers, brushes or sponges which have been previously used with abrasive cleaning agents)
- melamine eraser blocks
- sharp metal scrapers
- wire wool
- spot cleaning with mechanical cleaning agents
- oven cleaners
- stainless-steel spiral pads

If soiling is left on for any length of time, it may become impossible to remove. If items are used frequently without being cleaned, it may become very difficult to clean them. It is therefore best to remove any soiling immediately.

The accessories are not dishwasher-safe.

Tip: Soiling caused by spilt fruit juices and cake mixtures is best removed while the oven compartment is still warm.

To make it easier to clean the oven:

- Remove the door.
- Take out the side runners with Flexi-Clip runners (if fitted).
- Lower the top heat/grill element.

Removing normal soiling

There is a delicate fibreglass seal around the oven compartment to seal the glass in the oven door. This can be damaged by rubbing or scouring.

Avoid cleaning the fibreglass seal.

- Remove normal residues immediately with warm water, washing-up liquid and a clean sponge or a clean, damp microfibre cloth.
- Remove all cleaning agent residues thoroughly with clean water. This is particularly important for any parts with a PerfectClean finish, as cleaning agent residues will impair the non-stick function.
- After cleaning, wipe the surfaces dry using a soft cloth.

Cleaning and care

Removing stubborn soiling (excluding the FlexiClip runners)

Spilt fruit and roasting juices may cause lasting discolouration or matt patches on surfaces. This discolouration will not affect the properties of the surface finish.

Do not attempt to remove these stains. Only use the equipment specified.

- Baked-on deposits can be removed with a glass scraper or with a stainless-steel spiral pad (e.g. Spontex Spirinett), hot water and washing-up liquid.

Using oven cleaners

- Very stubborn soiling on PerfectClean surfaces can be cleaned using the Miele oven cleaner, which must only be applied to cold surfaces.

If the oven spray gets into gaps and openings, a strong odour is generated during subsequent cooking programmes.

Do not spray the oven cleaner onto the roof of the oven compartment.

Do not spray the oven cleaner into the gaps and openings of the oven compartment walls and rear wall.

- Follow the instructions on the packaging.

Oven cleaners from other manufacturers must only be used in a cold oven and for no longer than a maximum of 10 minutes.

- You can then also use the scouring pad on the back of a washing-up sponge to remove the soiling.

- Remove all cleaning agent residues thoroughly with clean water.
- Dry all surfaces with a soft cloth.

Stubborn soiling on the FlexiClip runners

Cleaning FlexiClip telescopic runners in a dishwasher would remove the special grease which is essential for their smooth functioning.

Never attempt to clean FlexiClip telescopic runners in a dishwasher.

For stubborn surface soiling or if the bearings become sticky with spilled fruit juices proceed as follows:

- Soak the FlexiClip runners for approx. 10 minutes in a solution of hot water and washing-up liquid. If necessary use the back of a washing-up sponge to remove the soiling. The bearings can be carefully cleaned with a soft brush.

Cleaning may cause some discolouration or fading in places, however this will not affect the functioning of the runners in any way.

Pyrolytic cleaning of the oven compartment

Instead of cleaning the oven compartment manually you can run the Pyrolytic  function.

During pyrolytic cleaning the oven compartment reaches temperatures in excess of 400 °C. Any residual soiling is burnt off and turned to ash by the high temperatures.

There are 3 pyrolytic settings available, each with a different duration:

- Level 1 for light soiling
- Level 2 for heavier soiling
- Level 3 for very heavy soiling

The oven door is automatically locked when the pyrolytic cleaning process is started. It cannot be opened until after the programme has finished.

The timer can be used to delay the start time of the pyrolytic cleaning programme, for instance to make use of cheaper electricity tariffs.

At the end of the pyrolytic cleaning programme any residues such as ash from the pyrolytic process, which are formed depending on the oven compartment's degree of soiling can be easily wiped away.

Preparing for pyrolytic cleaning

Accessories will be damaged by the high temperatures in pyrolytic cleaning.

Remove all accessories from the oven before starting the pyrolytic cleaning programme. This also applies to the side runners and any optional accessories.

Coarse soiling in the oven can cause thick smoke to develop.

Burnt-on residues can cause lasting discolouration or dull spots on enamelled surfaces.

Before starting the pyrolytic cleaning programme, remove coarse soiling from the oven and scrape any burnt-on residues off enamelled surfaces with a glass scraper.

- Remove any accessories from the oven compartment, including the side runners.

Cleaning and care

Starting Pyrolytic cleaning

 **Danger of burning.**
The oven door gets much hotter during pyrolytic operation than during normal use.
Prevent children from touching the oven during pyrolytic cleaning.

- Select Pyrolytic cleaning .



PY 1 will appear. The digit will flash.



Choose between *PY 1*, *PY 2* and *PY 3* using < or >.

- Select the level required.
- Confirm with *OK*.

Pyrolytic cleaning will now start.

 will also appear in the display.



While  is flashing, the door is locked automatically.  lights up as long as it is locked.

The oven heating and the cooling fan will then switch on automatically.

The oven interior lighting will not come on during the pyrolytic cleaning programme.

If you wish to follow the progress of the pyrolytic cleaning programme, you will need to call up the duration .

- Confirm with *OK*.
- Press > continuously until  flashes.

The time remaining of the pyrolytic cleaning programme will appear in the display. You cannot alter the duration.

If you have set a minute minder duration in the meantime, when the duration has elapsed a buzzer will sound,  will flash and the time will start counting up. When you confirm with *OK*, acoustic and optical signals are switched off. *PY* and the digit of the pyrolytic cleaning programme selected will appear again.

To delay the start time of the pyrolytic cleaning programme

Start the pyrolytic cleaning programme as described and delay the end time within the first five minutes.

- Confirm with *OK*.
- Press > continuously until  flashes.

The end time, calculated from the current time of day plus the duration of the pyrolytic cleaning programme selected, will appear in the display.

- Confirm with *OK*.

The hours will flash.

- Set the hours using >.

- Confirm with *OK*.

The minutes will flash.

- Use > to set the minutes.

- Confirm with *OK*.



The end time set is now saved.



The oven heating switches off.

The end time can be changed at any time up to the start of the programme.

As soon as the start time has been reached, the oven heating, lighting and cooling fan will switch on and the duration will appear in the display.



At the end of pyrolytic cleaning

First 0:00,  and  appear.

As long as  lights up, the door is locked. When  flashes, the door is unlocked.



When the door lock is released:

-  goes out.
-  will flash.
- A buzzer will sound if switched on (see “Clock/timer - Changing settings”).

- Turn the function selector to **0**.

The visual and acoustic signals will switch off.

 Risk of injury caused by hot surfaces.

At the end of the pyrolytic cleaning programme, the oven will still be very hot. You could burn yourself on the heating elements and oven compartment.

Allow the heating elements and the oven compartment temperature to drop to a safe level before removing any residues.

- Clean the oven compartment to remove any pyrolytic residues (e.g. ash) that may have built up depending on the degree of soiling in the oven.

Cleaning and care

Most residues can be removed with warm water, a little washing-up liquid and a clean sponge or a clean, damp microfibre cloth.

Depending on the level of soiling, a visible deposit could build up on the glass on the inside of the oven door. This can be removed with a dishwashing sponge, a glass scraper or a stainless steel spiral scourer and a little washing-up liquid.



There is a delicate fibreglass seal around the oven compartment to seal the glass in the oven door. This can be damaged by rubbing or scouring.

Avoid cleaning the fibreglass seal.

Enamelled surfaces can be permanently discoloured by spilt fruit juices. Such discolouration does not affect the properties of the enamel.

Do not attempt to remove these stains.

If pyrolytic cleaning is cancelled

If pyrolytic cleaning is cancelled, the oven door will remain locked until the temperature inside the oven drops to below 280 °C.  remains lit up until the temperature of the oven cavity has fallen below this temperature. When  flashes, the door is unlocked.

The following will cause the pyrolytic cleaning programme to stop:

- Turn the function selector to another function or to the **0** position.

Turn the function selector to Pyrolytic cleaning  again, if you want to start the pyrolytic cleaning programme anew.

- A power cut.

When power is restored, *Py* remains lit up until the temperature of the oven cavity has fallen below 280 °C. After that the numeric block will appear,  will flash and the door will unlock. Then *Py* will flash in the display.

- Confirm with *OK* if you want to start the pyrolytic cleaning programme again. Then you can select the pyrolytic cleaning programme you want and start it again.

As soon as you turn the function selector to the **0** position following an interruption to the power supply, *Py* will carry on flashing. Confirm with *OK* to enter the time of day again (see “Before using for the first time”).

Door removal

The door weighs approx. 10 kg.

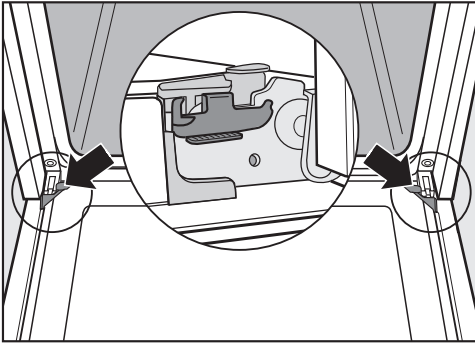

The oven door is connected to the door hinges by retainers.

Before removing the door from the retainers, the locking clamps on both door hinges have to be released.

- Open the door fully.

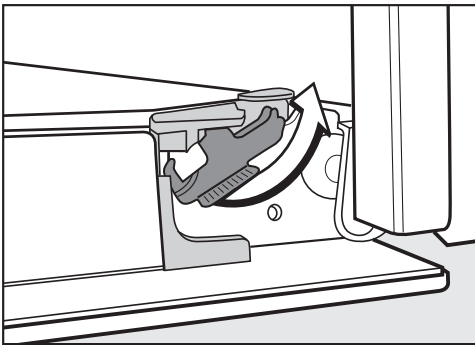

- Release the locking clamps by turning them as far as they will go.

The oven could become damaged if you incorrectly remove the door. Never pull the door horizontally off its retainers, as they will spring back against the oven. Never pull the door off the retainers by the handle, as the handle could break off.

- Raise the door up till it rests partially open.



- Hold the door on either side and pull it diagonally upwards off the retainers. Make sure that the door goes back on straight.

Cleaning and care

Dismantling the door

The oven door is an open system with 4 glass panes which have a heat-reflective coating on some of their surfaces.

When the oven is operating, air is directed through the door to keep the outer pane cool.

If soiling has worked its way in between the glass panes, the door can be dismantled in order to clean in between the panes.

Scratches on the door glass can cause the glass to break.

Do not use abrasive cleaners, hard sponges, brushes or sharp metal tools to clean the door glass.

When cleaning the door glass, you must also follow the instructions that apply to the oven front.

The different sides of the door glass have different coatings. The sides facing the oven compartment have heat-reflecting properties.

The oven could become damaged if you fit the door glass the wrong way round.

Make sure that you place the door glass back in the right position after cleaning.

Oven cleaners will damage the surface of the aluminium profiles.

Only clean these parts with warm water and washing-up liquid, applied with a clean sponge cloth or a clean, damp microfibre cloth.

The door glass could break if dropped.

Keep the disassembled door glass in a safe place.

Cleaning and care

 Risk of injury caused by door slamming shut.

The door may slam shut if you attempt to disassemble it when it is fitted to the oven.

Always remove the door before disassembling it.

- Place the door with the outer glass pane on a soft surface (e.g. a tea towel) to prevent it getting scratched. The door handle should line up with the edge of the table so that the glass lies flat and does not get broken during cleaning.

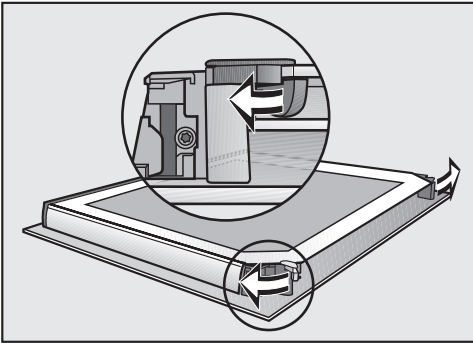

- Flip the two glass pane retainers outwards to open them.

You can now remove the inner panes and the two middle panes one after the other:

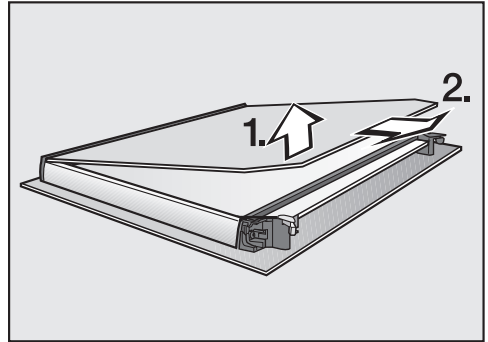

- **Gently** lift the inner pane up and out of the plastic strip.

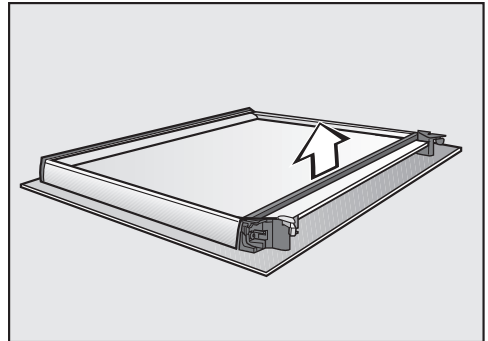

- Remove the seal.

Cleaning and care

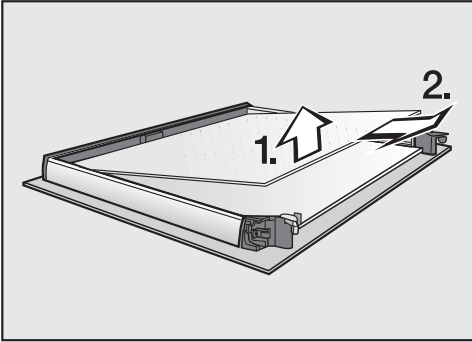

- Carefully lift the top of the two middle panes up and take it out.

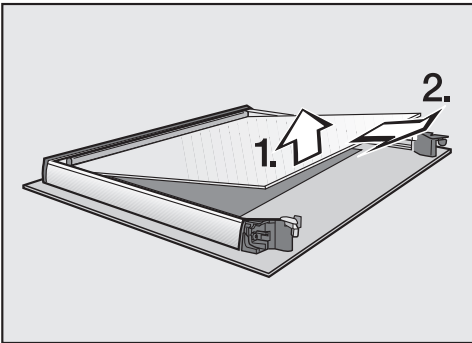

- Then lift the bottom of the two middle panes up carefully and take it out.
- Clean the door panes and other parts with a clean sponge and a solution of hot water and washing-up liquid or a clean, damp microfibre cloth.
- Dry all parts with a soft cloth.

Then reassemble the door carefully:

The two middle panes are identical. To help you put them back in correctly, the material number is printed on the panes.

- Refit the lower of the two middle panes in such a way that the material number is legible (i.e. not reversed).

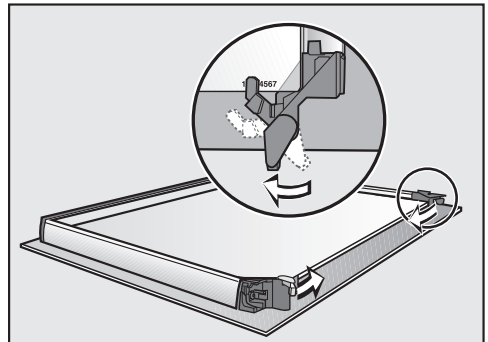

- Flip both the glass pane retainers inwards in such a way that they fit over the lower of the two middle panes.
- Refit the upper of the two middle panes in such a way that the material number is legible (i.e. not reversed). The pane must rest on the retainers.

Cleaning and care

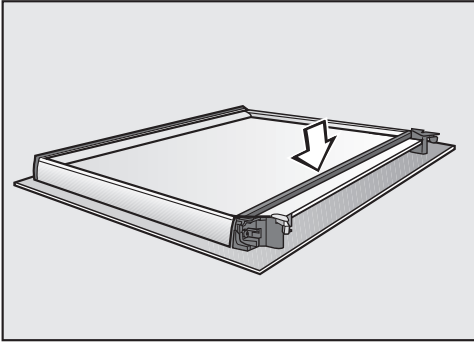

- Refit the seal.

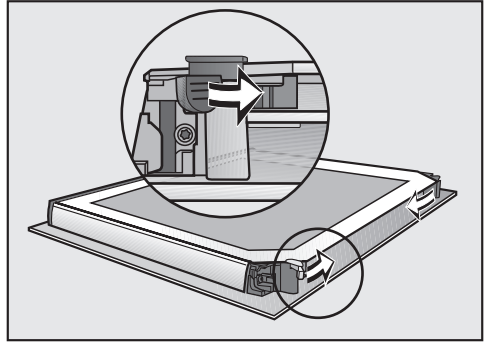

- Flip both the glass pane retainers inwards to close them.

The door is now reassembled.

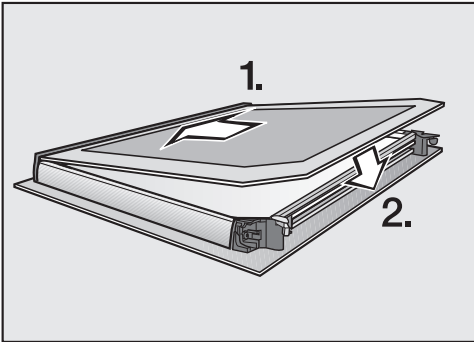

- Push the inner pane with the matt printed side facing downwards into the plastic strip and place it between the retainers.

Cleaning and care

Fitting the door

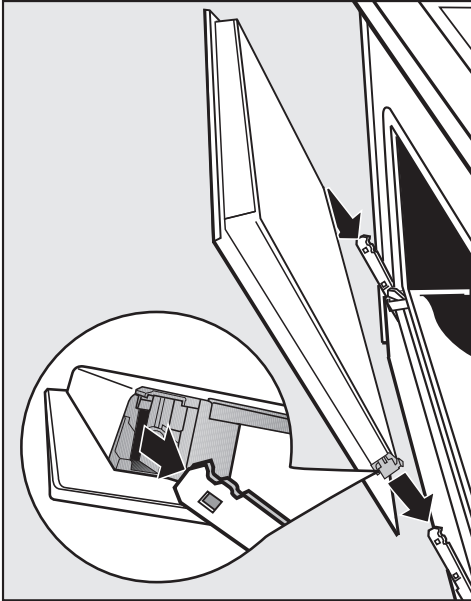

- Hold the door securely on both sides and carefully fit it back into the hinge retainers. Make sure that you fit the door straight.

- Open the door fully.

If the locking clamps are not locked, the door could become loose, resulting in damage.

Always ensure that the locking clamps are locked after refitting the door.

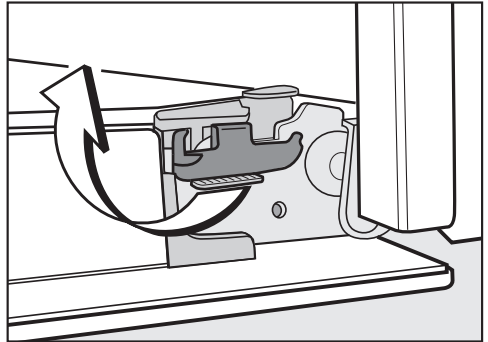

- To relock the locking clamps, turn them back up to the horizontal position as far as they will go.

Removing the side runners with FlexiClip runners

The side runners can be removed together with the FlexiClip runners (if inserted).

If you wish to remove the FlexiClip runners separately beforehand, please follow the instructions in “Features” – “Fitting and removing FlexiClip runners”.

 **Danger of injury caused by hot surfaces.**

The oven gets hot during operation. You could burn yourself on the heating elements, oven compartment or accessories.

Allow the heating elements, oven compartment and accessories to cool before removing the side runners.

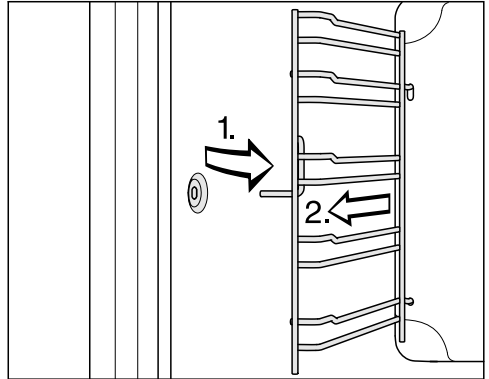

- Pull the side runners out of holder (1.) and remove them (2.).

Reassemble by following these instructions in reverse order.

- Insert the components carefully.

Cleaning and care

Lowering the top heat/grill element

If the oven compartment roof is badly soiled, the top heat/grill element can be lowered to make cleaning easier. Clean the oven compartment roof regularly with a damp cloth or a dishwashing sponge.

⚠ Danger of injury caused by hot surfaces.

The oven gets hot during operation. You could burn yourself on the heating elements, oven compartment or accessories.

Allow the heating elements, oven compartment and the accessories to cool before manual cleaning.

The enamel on the oven floor can become damaged by fastening nuts being dropped on it.

Place a cloth or similar item over the oven compartment floor to protect it.

- Remove the side runners.

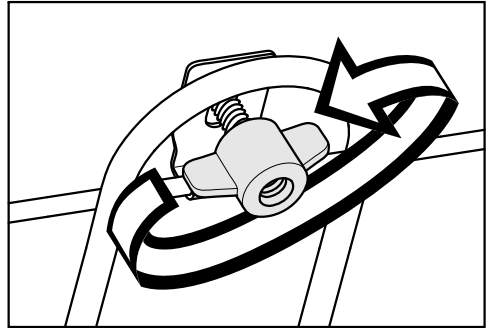

- Unscrew the wing nut.

Be careful not to damage the top heat/grill element.

Never use force when lowering the top heat/grill element.

- Carefully lower the top heat/grill element.



You can now access the top of the oven compartment.

- Clean the oven compartment roof with a clean sponge and a solution of hot water and washing-up liquid or a damp microfibre cloth.
- After cleaning, raise the top heat/grill element gently back up again.
- Replace the wing nut and tighten it securely.
- Refit the side runners.

Problem solving guide

Many malfunctions and faults that can occur in daily operation can be easily remedied. Time and money will be saved because a service call will not be needed.

The following guide may help you to find the reason for a malfunction or a fault, and to correct it.

| Problem | Cause and remedy |
|---|--|
| The display is dark. | <p>There is no power to the oven.</p> <ul style="list-style-type: none"> ■ Check whether the mains fuse has tripped. If it has, contact a qualified electrician or Miele. |
| The oven compartment does not heat up. | <p>The  system lock has been activated.</p> <ul style="list-style-type: none"> ■ Switch off the system lock (see “Clock/timer – Changing settings”). |
| | <p>There is no power to the oven.</p> <ul style="list-style-type: none"> ■ Check whether the fuse has tripped. Contact a qualified electrician or the Customer Service Department for assistance. |
| 12:00 is flashing in the display. | <p>There has been a power cut.</p> <ul style="list-style-type: none"> ■ Reset the time of day (see “Using for the first time”). <p>Cooking times will also need to be reset.</p> |
| 0:00 appears unexpectedly in the display and the  symbol flashes at the same time. The buzzer may also be sounding. | <p>The oven has been operating for an unusually long time and this has activated the safety switch-off function.</p> <ul style="list-style-type: none"> ■ Turn the function selector to 0. The oven is now ready to use again immediately. |
| Py is lit up or flashing in the display. | <p>There has been a power cut which has caused the pyrolytic cleaning programme to stop.</p> <div style="border: 1px solid gray; padding: 5px; margin: 10px 0;"> <p>The  symbol will remain lit up and the door locked until the temperature inside the oven drops to below 280 °C.</p> </div> <ul style="list-style-type: none"> ■ As soon as you turn the function selector to 0, the time of day flashes. You have to reset the time of day (see “Before using for the first time”). |



Problem solving guide

| Problem | Cause and remedy |
|---|---|
| F 32 appears in the display. | The door lock for pyrolytic cleaning has not locked. <ul style="list-style-type: none"> ■ Turn the function selector to 0 and select the required pyrolytic cleaning programme again. If the problem persists, call the Miele Customer Service Department. |
| F 33 appears in the display. | The door lock for pyrolytic cleaning has not opened. <ul style="list-style-type: none"> ■ Turn the function selector to 0. If the problem persists, call the Miele Customer Service Department. |
| F XX appears in the display. | A fault has occurred that you cannot resolve. <ul style="list-style-type: none"> ■ Call the Miele Customer Service Department. |
| The buzzer does not sound. | The buzzers are switched off. <ul style="list-style-type: none"> ■ Switch on the buzzer (see “Clock/timer – Changing settings”). |
| A noise can be heard after a cooking process. | The cooling fan will continue to run for a while after the oven has been switched off to prevent any humidity building up in the oven, on the control panel or in the oven housing unit. This cooling fan will switch itself off automatically after a certain period of time. |
| The oven has switched itself off. | To save power, the oven switches off automatically if a button is not pressed after a certain amount of time or after a cooking programme has ended. <ul style="list-style-type: none"> ■ Switch the oven back on. |
| Cakes and biscuits are not baked properly after following the times given in the baking chart. | A different temperature from the one given in the recipe was used. <ul style="list-style-type: none"> ■ Select the temperature required for the recipe. |
| | The ingredient quantities are different from those given in the recipe. <ul style="list-style-type: none"> ■ Check whether you amended the recipe. The addition of more liquid or more eggs makes a moister mix which requires a longer cooking duration. |

Problem solving guide

| Problem | Cause and remedy |
|--|--|
| <p>The browning of the baked goods is uneven.</p> | <p>The wrong temperature or shelf level was selected.</p> <ul style="list-style-type: none"> ■ There will always be a slight unevenness in browning. If browning is very uneven, check whether the correct temperature and shelf level were selected. <p>The material or colour of the bakeware is not suitable for the oven function selected.</p> <ul style="list-style-type: none"> ■ When using the Conventional heat  function, light coloured, shiny tins will not produce as desirable results. Dark, matt tins are best for baking. |
| <p>The FlexiClip runners do not push in or pull out smoothly.</p> | <p>The bearings in the FlexiClip runners are not sufficiently lubricated.</p> <ul style="list-style-type: none"> ■ Lubricate the bearings with the special Miele lubricant. <p>Only the special Miele lubricant is designed for the high temperatures in the oven compartment. Other lubricants may resinify when heated and will gum up the FlexiClip runners. You can obtain the special Miele lubricant from your Miele dealer or from the Miele Customer Service Department.</p> |
| <p>There is still soiling in the oven compartment after a pyrolytic cleaning programme.</p> | <p>The pyrolytic cleaning programme burns off soiling in the oven and leaves it as ash.</p> <ul style="list-style-type: none"> ■ Remove the ash using a damp microfibre cloth or with a clean sponge and a solution of hot water and washing-up liquid. <p>If there is still coarse soiling left in the oven after the pyrolytic cleaning programme you should start the programme again, selecting a longer duration if necessary.</p> |
| <p>The door will not open after the pyrolytic cleaning programme.</p> | <p>The door lock for pyrolytic cleaning has not opened.</p> <ul style="list-style-type: none"> ■ Turn the function selector to 0. ■ If the door lock still does not release itself call the Customer Service Department. |

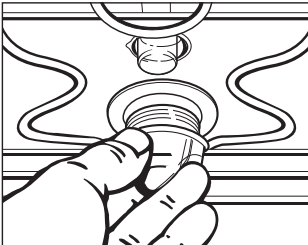
Problem solving guide

| Problem | Cause and remedy |
|--|---|
| <p data-bbox="73 201 350 288">The top oven interior lighting does not turn on.</p>  | <p data-bbox="400 201 720 233">The halogen lamp is faulty.</p> <div data-bbox="406 240 1038 400" style="border: 1px solid gray; padding: 5px;"><p data-bbox="417 248 689 280">⚠ Danger of burning!</p><p data-bbox="417 288 1009 376">Make sure the oven heater elements are switched off. Make sure the oven compartment has cooled down.</p></div> <ul data-bbox="400 416 1032 775" style="list-style-type: none"><li data-bbox="400 416 1032 504">■ Disconnect the oven from the mains. Switch off at the wall and withdraw the plug from the socket or switch off the fuse of the electrical installation.<li data-bbox="400 512 1032 600">■ Turn the lamp cover a quarter turn anti-clockwise to release it and then pull it together with its seal downwards to take it out.<li data-bbox="400 608 1032 663">■ Replace the halogen lamp (Osram 66725 AM/A, 230 V, 25 W, G9).<li data-bbox="400 671 1032 727">■ Refit the lamp cover together with its seal and turn clockwise to secure.<li data-bbox="400 735 1032 775">■ Reconnect the oven to the electricity supply. <p data-bbox="400 791 1032 880">You have selected the Eco Fan heat  function. The oven interior lighting does not switch on in this function.</p> |

Contact in case of malfunction

In the event of any faults which you cannot remedy yourself, please contact your Miele Dealer or Miele Service.

Contact information for Miele Service can be found at the end of this document.

Please note that telephone calls may be monitored and recorded for training purposes and that a call-out charge will be applied to service visits where the problem could have been resolved as described in this booklet.

Please quote the model and serial number of your appliance when contacting Miele. This information can be found on the data plate.

This information is given on the data plate, visible on the front frame of the oven, with the door fully open.

Warranty

For information on the appliance warranty specific to your country please contact Miele. See back cover for address.

In the UK, your appliance warranty is valid for 2 years from the date of purchase. However, you must activate your cover by calling 0330 160 6640 or registering online at www.miele.co.uk.

Installation

Installation dimensions

Dimensions are given in mm.

Installation in a tall or base unit

When building the oven into a base unit underneath a hob, please also observe the installation instructions for the hob as well as the building-in depth required for the hob.

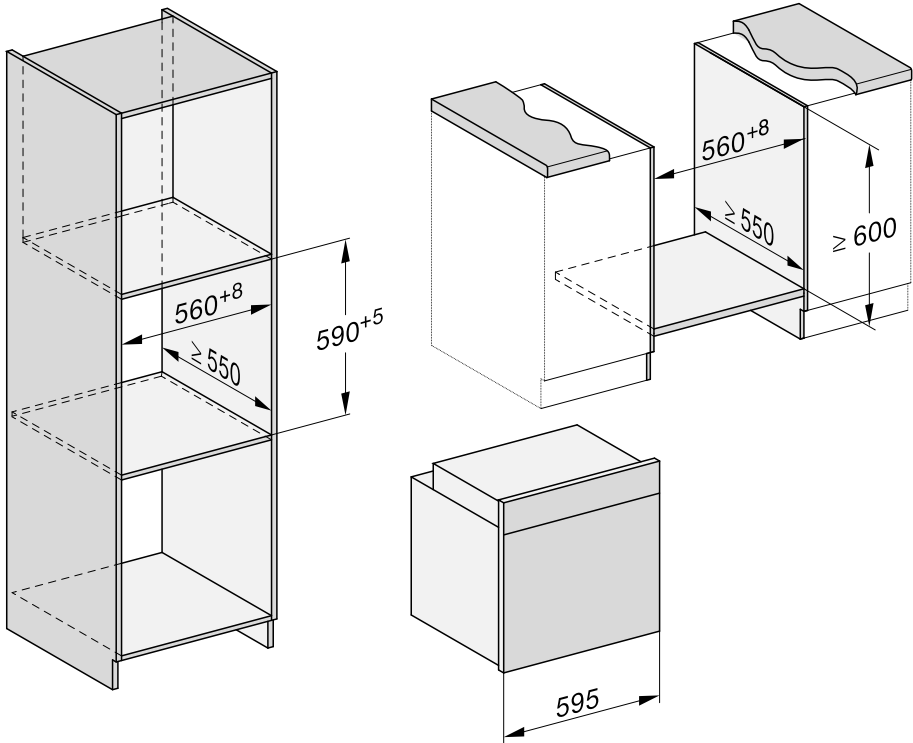

Side view of H 22xx

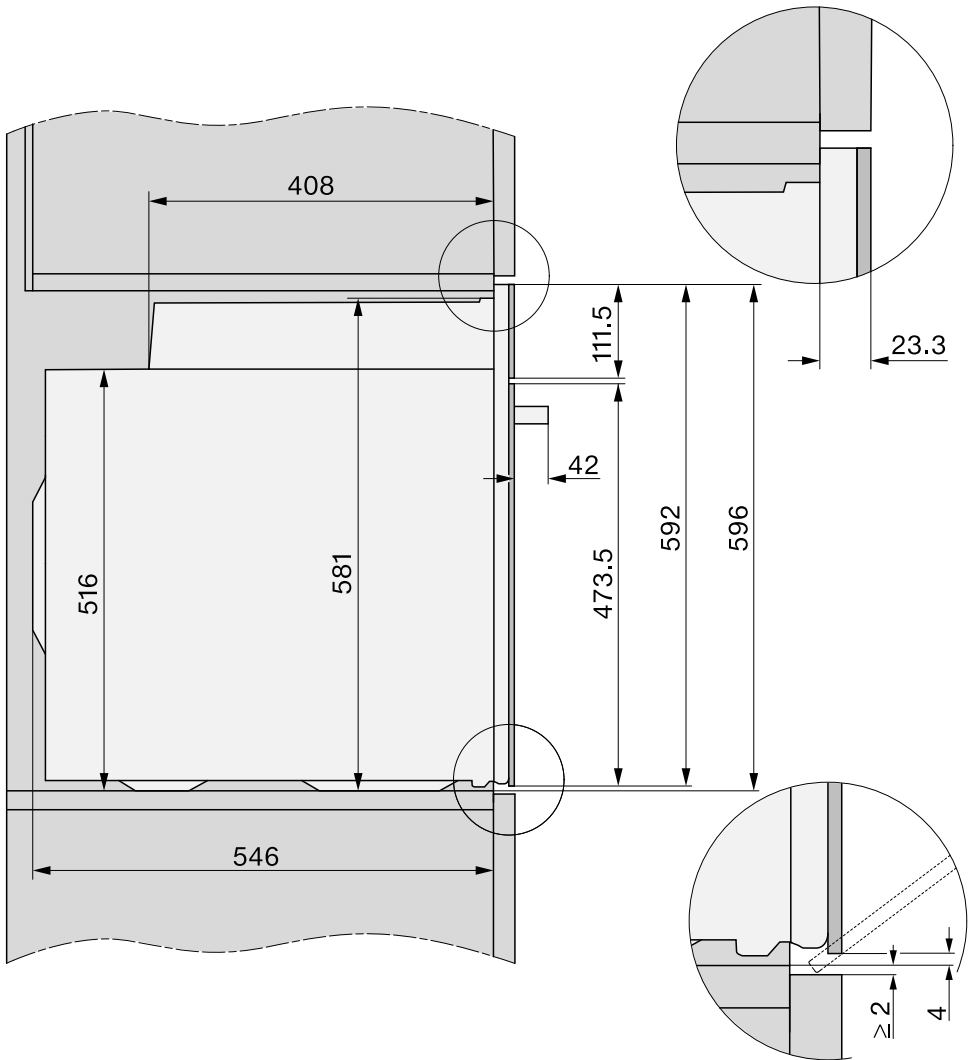

Installation

Side view H 28xx, H 25xx, H 27xx

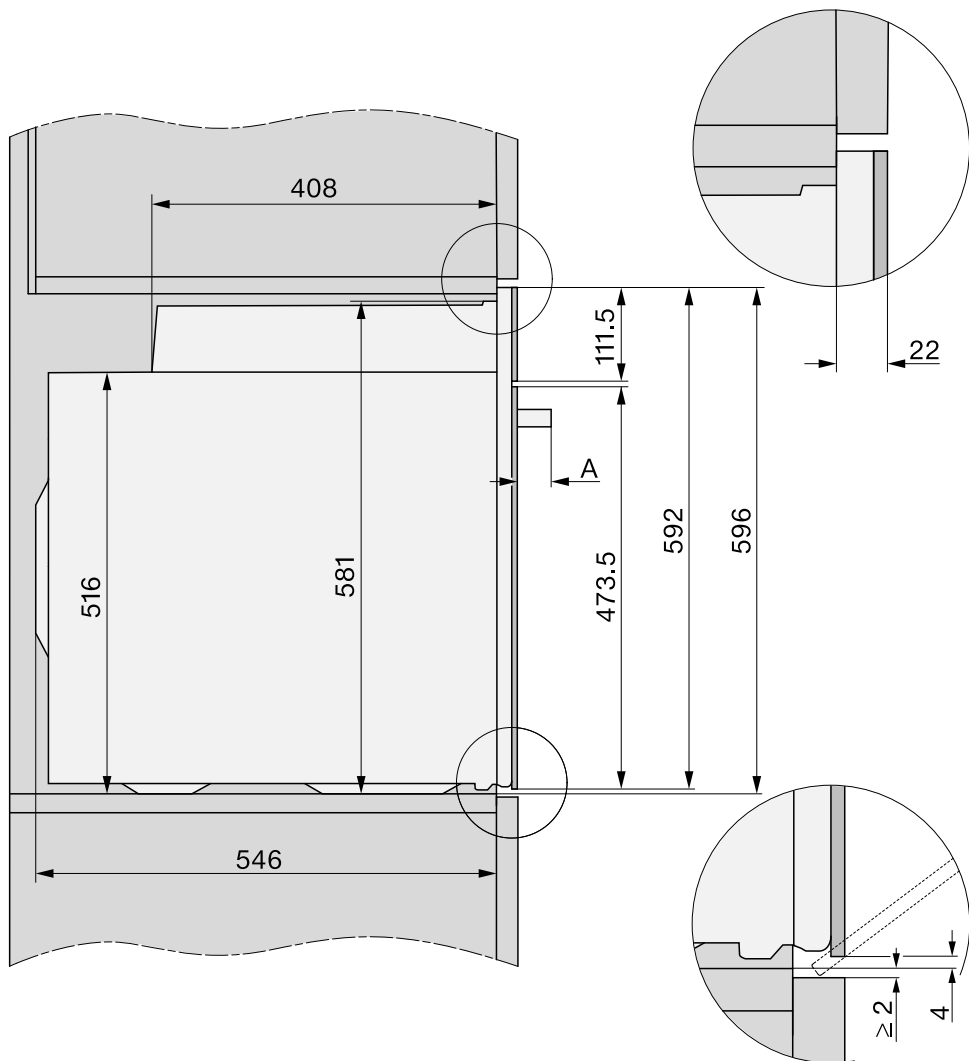

A H 25xx, H 27xx: 43 mm
H 28xx: 47 mm

Connections and ventilation

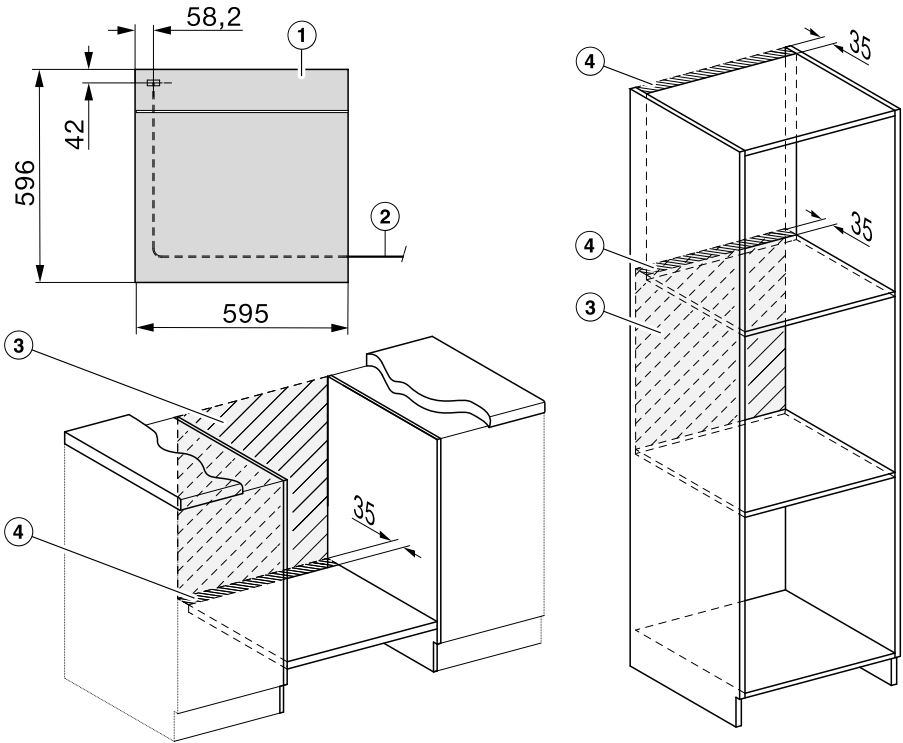

- ① Front view
- ② Mains connection cable, length = 2000 mm
- ③ No connections permitted in this area
- ④ Ventilation cut-out, min. 150 cm²

Installation

Installing the oven

For safety reasons, the oven may only be used when it has been fully installed.

The oven requires a sufficient supply of cool air for efficient operation. The required supply of cool air must not be excessively heated by other heat sources (e.g. solid fuel stoves).

The following must be observed when installing the appliance:
Make sure that the shelf that the oven sits on does not touch the wall.
Do not fit heat insulation strips to the side walls of the housing unit.

- Connect the oven to the electrical supply.

Do not carry the oven by the door handle. The door can be damaged.
Use the handle cut-outs on the side of the housing to lift the appliance.

It is a good idea to remove the door (see “Cleaning and care” – “Door removal”) and to remove the accessories before installing the appliance. This makes the oven lighter when you push it into the housing unit and you do not run the risk of lifting it by the door handle by mistake.

- Push the oven into the housing unit and align it.
- Open the door, if you have not removed it.

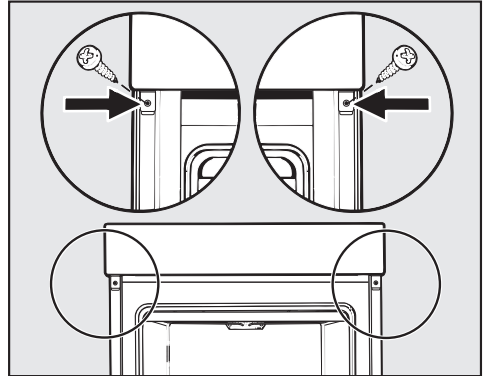

- Use the screws supplied to secure the oven to the side walls of the housing unit.
- Refit the door if necessary (see “Cleaning and care” – “Fitting the door”).

Electrical connection

 **Danger of injury!**
Installation, repairs and other work by unqualified persons could be dangerous. Miele cannot be held liable for unauthorised work.

Connection to the electrical supply must be carried out by a suitably qualified and competent person in accordance with local and national safety regulations. Ensure power is not supplied to the appliance until after installation or repair work has been carried out.

All electrical work should be carried out by a suitably qualified and competent Miele approved service technician in strict accordance with current national and local safety regulations (BS 7671 in the UK).

Connection should be made via a fused connection unit or a suitable isolator, which complies with national and local safety regulations, and the on/off switch should be easily accessible after the appliance has been installed.

If the switch is not accessible after installation (depending on country) an additional means of disconnection must be provided for all poles.

Switches with a minimum all-pole contact gap of 3 mm are suitable for isolating the appliance. These include circuit breakers, fuses and protective devices.

Connection data

The required connection data are given on the data plate located on the oven trim visible when the door is open.

Ensure that these match the mains supply.

- When contacting Miele, please quote the following:
 - Model number
 - Serial number
 - Connection data (voltage/frequency/maximum connected load)

When replacing the cable supplied with another cable or changing the connection, only cable type H05VV-F with a suitable cross-sectional area (CSA) may be used.

Oven

The wires in the mains lead are coloured as follows:

Green/yellow = earth

Blue = neutral

Brown = live

 **WARNING - THIS APPLIANCE MUST BE EARTHED**

For extra safety it is advisable to protect the appliance with a suitable residual current device (RCD).

Maximum connected load: see data plate.

Installation

Electrical connection: Other countries

All electrical work should be carried out by a suitably qualified and competent Miele approved service technician in strict accordance with local and national safety regulations.

Connection should be made via a fused connection unit or a suitable isolator, which complies with national and local safety regulations, and the on/off switch should be easily accessible after the appliance has been installed.

If the switch is not accessible after installation (depending on country) an additional means of disconnection must be provided for all poles.

Switches with a minimum all-pole contact gap of 3 mm are suitable for isolating the appliance. These include circuit breakers, fuses and protective devices.

The voltage and rated load are given on the data plate situated at the front of the oven interior. Please ensure that these match the household mains supply.

For extra safety it is advisable to install a suitable residual current device (RCD) / ground fault interrupter (GFI). Contact a qualified electrician for advice.

If the cord is damaged a new cord must be fitted by a Miele approved service technician.

Hong Kong























This appliance is supplied with a power cord with plug for connection to a 230 V, 50 Hz socket outlet.







Taiwan

This appliance is supplied with a power cord with plug for connection to a 220 V, 60 Hz socket outlet.

 **WARNING - THIS APPLIANCE
MUST BE EARTHED**

Batter

| Cakes/biscuits (accessories) |  |  °C |  5 1 |  [min] |
|--|---|--|--|--|
| Muffins (1 tray) |  | 150–160 | 2 | 25–35 |
| Muffins (2 trays) |  | 150–160 | 1+3 | 30–40 ³ |
| Small cakes (1 tray)* |  | 150 | 2 ² | 25–35 |
| |  | 160 ¹ | 3 ² | 20–30 |
| Small cakes (2 trays)* |  | 150 ¹ | 2+4 ² | 25–35 |
| |  | 150–160 | 2 | 60–70 |
| Madeira cake (loaf tin, 30 cm) |  | 150–160 | 2 | 60–70 |
| |  | 155–165 ¹ | 2 | 60–70 |
| Marble, nut cake (loaf tin, 30 cm) |  | 150–160 | 2 | 55–65 |
| |  | 150–160 | 2 | 60–70 |
| Marble, nut cake (ring tin/Bundt cake tin, Ø 26 cm) |  | 150–160 | 2 | 55–65 |
| |  | 150–160 | 2 | 55–65 |
| Fresh fruit cake (tray) |  | 160–170 | 2 | 45–55 |
| |  | 155–165 | 1 | 45–55 |
| Fresh fruit cake (springform cake tin, Ø 26 cm) |  | 150–160 | 2 | 55–65 |
| |  | 170–180 ¹ | 1 | 35–45 |
| Flan base (flan base tin, Ø 28 cm) |  | 150–160 | 2 | 25–35 |
| |  | 170–180 ¹ | 2 | 15–25 |

























 Function,  Temperature,  Shelf level,  Cooking duration,  Fan plus,  Conventional heat









* The settings also apply for testing in accordance with EN 60350-1.

- 1 Pre-heat the oven before putting food inside. Do not use the  Booster function for this purpose.
- 2 Remove the FlexiClip runners if fitted.
- 3 Take the trays out of the oven early if the food is sufficiently browned before the specified cooking duration has elapsed.

Cooking charts

Shortcrust pastry





















| Cakes/biscuits (accessories) |  |  [°C] |  5 1 |  [min] |
|---|---|--|---|--|
| Biscuits (1 tray) |  | 140–150 | 2 | 20–30 |
| |  | 150–160 | 2 | 25–35 |
| Biscuits (2 trays) |  | 140–150 | 1+3 | 20–30 ³ |
| Drop cookies (1 tray)* |  | 140 | 2 ² | 35–45 |
| |  | 160 ¹ | 3 ² | 20–30 |
| Drop cookies (2 trays)* |  | 140 | 1+3 ² | 35–45 ³ |
| Flan base (flan base tin, Ø 28 cm) |  | 150–160 | 2 | 35–45 |
| |  | 170–180 ¹ | 2 | 20–30 |
| Cheesecake (springform cake tin, Ø 26 cm) |  | 170–180 | 2 | 80–90 |
| |  | 150–160 | 2 | 80–90 |
| Apple pie, single crust (springform cake tin, Ø 20 cm)* |  | 160 | 2 ² | 90–100 |
| |  | 180 | 1 ² | 90–100 |
| Apple pie, double crust (springform cake tin, Ø 26 cm) |  | 180–190 ¹ | 2 | 60–70 |
| |  | 160–170 | 2 | 60–70 |
| Fresh fruit cake, glazed (springform cake tin, Ø 26 cm) |  | 170–180 | 2 | 60–70 |
| |  | 150–160 | 2 | 55–65 |
| Fresh fruit cake, glazed (tray) |  | 170–180 | 2 | 50–60 |
| |  | 160–170 | 2 | 45–55 |
| Fruit flan (tray) |  | 210–220 ¹ | 1 | 55–65 |
| |  | 180–190 | 1 | 35–45 |







 Function,  Temperature,  Shelf level,  Cooking duration,  Fan plus,  Eco fan heat,  Conventional heat,  Intensive bake

* The settings also apply for testing in accordance with EN 60350-1.

- 1 Pre-heat the oven before putting food inside. Do not use the  Booster function for this purpose.
- 2 Remove the FlexiClip runners if fitted.
- 3 Take the trays out of the oven early if the food is sufficiently browned before the specified cooking duration has elapsed.

Yeast dough









| Cakes/biscuits (accessories) |  |  [°C] |  5 1 |  [min] |
|---|---|--|--|--|
| Bundt cake (Bundt cake tin, Ø 24 cm) |  | 150–160 | 2 | 50–60 |
| |  | 160–170 | 1 | 50–60 |
| Stollen |  | 150–160 | 2 | 55–65 |
| |  | 160–170 | 2 | 55–65 |
| Streusel cake with/without fruit (tray) |  | 160–170 | 2 | 40–50 |
| |  | 170–180 | 3 | 45–55 |
| Fresh fruit cake (tray) |  | 160–170 | 2 | 45–55 |
| |  | 170–180 | 3 | 45–55 |
| Apple turnovers/raisin whirls (1 tray) |  | 160–170 | 2 | 25–35 |
| Apple turnovers/raisin whirls (2 trays) |  | 160–170 | 1+3 | 30–40 ³ |
| White loaf (free form) |  | 180–190 | 2 | 35–45 |
| |  | 190–200 | 2 | 30–40 |
| White bread (loaf tin, 30 cm) |  | 180–190 | 2 | 35–45 |
| |  | 190–200 ¹ | 2 | 30–40 |
| Wholegrain bread (loaf tin, 30 cm) |  | 180–190 | 2 | 55–65 |
| |  | 200–210 ¹ | 2 | 45–55 |
| Proving yeast dough |  | 30–35 | – ² | – |





 Function,  Temperature,  Shelf level,  Cooking duration,  Fan plus,  Conventional heat

- ¹ Pre-heat the oven before putting food inside. Do not use the  Booster function for this purpose.
- ² Place the rack on the floor of the oven and stand the bowl containing the dough on the rack. Depending on the size of the bowl, you may need to remove the side runners.
- ³ Take the trays out of the oven early if the food is sufficiently browned before the specified cooking duration has elapsed.

Cooking charts









Quark dough







| Cakes/biscuits (accessories) |  |  [°C] |  ⁵ 1 |  [min] |
|---|---|---|---|---|
| Fresh fruit cake (tray) |  | 160–170 | 2 | 40–50 |
| |  | 170–180 | 3 | 50–60 |
| Apple turnovers/raisin whirls (1 tray) |  | 160–170 | 3 | 25–35 |
| Apple turnovers/raisin whirls (2 trays) |  | 150–160 | 1+3 | 25–35 ¹ |

 Function,  Temperature, ⁵ Shelf level,  Cooking duration,  Fan plus,  Conventional heat

¹ Take the trays out of the oven early if the food is sufficiently browned before the specified cooking duration has elapsed.

Sponge mixture

| Cakes/biscuits (accessories) |  |  [°C] |  ⁵ 1 |  [min] |
|---|---|---|---|---|
| Sponge cake base (2 eggs, springform cake tin, Ø 26 cm) |  | 160–170 ¹ | 2 | 15–25 |
| Sponge cake base (4–6 eggs, springform cake tin, Ø 26 cm) |  | 150–160 ¹ | 2 | 30–40 |
| Whisked sponge (springform cake tin, Ø 26 cm)* |  | 180 | 2 ² | 25–35 |
| |  | 150–170 ¹ | 2 ² | 25–45 |
| Swiss roll sponge (baking tray) |  | 180–190 ¹ | 2 | 15–25 |











 Function,  Temperature, ⁵ Shelf level,  Cooking duration,  Fan plus,  Conventional heat

* The settings also apply for testing in accordance with EN 60350-1.

- 1 Pre-heat the oven before putting food inside. Do not use the  Booster function for this purpose.
- 2 Remove the FlexiClip runners if fitted.

Cooking charts

















Choux pastry, puff pastry, meringue











| Cakes/biscuits (accessories) |  |  [°C] |  ⁵ 1 |  [min] |
|--|---|---|---|---|
| Choux buns (1 tray) |  | 160–170 | 2 | 30–40 |
| Pastry puffs (1 tray) |  | 180–190 | 2 | 20–30 |
| Pastry puffs (2 trays) |  | 180–190 | 1+3 | 20–30 ¹ |
| Macaroons (1 tray) |  | 120–130 | 2 | 25–50 |
| Macaroons (2 trays) |  | 120–130 | 1+3 | 25–50 ¹ |
| Meringues/pavlovas (1 tray of 6, each Ø 6 cm) |  | 80–100 | 2 | 120–150 |
| Meringues/pavlovas (2 trays of 6, each Ø 6 cm) |  | 80–100 | 1+3 | 150–180 |

 Function,  Temperature, ⁵ Shelf level,  Cooking duration,  Fan plus

¹ Take the trays out of the oven early if the food is sufficiently browned before the specified cooking duration has elapsed.

Savoury dishes

| Food (accessories) |  | Temperature [°C] | Shelf level ⁵  | Cooking duration [min] |
|--|---|----------------------|---|---------------------------|
| Savoury flan (tray) |  | 220–230 ² | 1 | 25–35 |
| |  | 180–190 | 1 | 30–40 |
| Onion tart (tray) |  | 180–190 ² | 2 | 25–35 |
| |  | 170–180 | 2 | 30–40 |
| Pizza, yeast dough (tray) |  | 170–180 | 2 | 25–35 |
| |  | 210–220 ² | 2 | 20–30 |
| Pizza, quark-oil dough (tray) |  | 170–180 | 2 | 25–35 |
| |  | 190–200 ² | 2 | 25–35 |
| Frozen pizza, pre-cooked (rack) |  | 200–210 | 2 | 20–25 |
| Toast* (rack) |  | 250 | 3 | 5–8 |
| Baked dishes/gratins (e.g. toast) ¹ |  | 250 ³ | 3 | 3–6 |
| Grilled vegetables ¹ |  | 250 ³ | 4 | 5–10 ⁴ |
| |  | 250 ³ | 3 | 5–10 ⁴ |
| Ratatouille (universal tray) |  | 180–190 | 2 | 40–60 |

 Function,  Temperature,  Shelf level,  Cooking duration,  Conventional heat,  Intensive bake,  Fan plus,  Eco fan heat,  Full grill,  Fan grill

* The settings also apply for testing in accordance with EN 60350-1.

¹ Use the rack and universal tray.

















² Pre-heat the oven before putting food inside. Do not use the  Booster function for this purpose.

³ Pre-heat the oven for 5 minutes before putting food inside. Do not use the  Booster function for this purpose.

⁴ Turn the food halfway through cooking.

Cooking charts

Beef

| Food (accessories) |  |  [°C] |  ⁵ ₁ |  [min] |  ⁹ [°C] |
|--|--|--|---|---|--|
| Braised beef, approx. 1 kg (oven dish with lid) |  ² | 150–160 ³ | 2 | 120–130 ⁶ | -- |
| |  ² | 170–180 ³ | 2 | 120–130 ⁶ | -- |
| |  ² | 180–190 | 2 | 160–180 ⁷ | -- |
| Fillet of beef, approx. 1 kg (universal tray) |  ² | 180–190 ³ | 2 | 25–60 | 45–75 |
| Fillet of beef, “rare”, approx. 1 kg ¹ |  ² | 80–85 ⁴ | 2 | 70–80 | 45–48 |
| Fillet of beef, “medium”, approx. 1 kg ¹ |  ² | 90–95 ⁴ | 2 | 80–90 | 54–57 |
| Fillet of beef, “well done”, approx. 1 kg ¹ |  ² | 95–100 ⁴ | 2 | 110–130 | 63–66 |
| Sirloin joint, approx. 1 kg (universal tray) |  ² | 180–190 ³ | 2 | 35–65 | 45–75 |
| Sirloin joint, “rare”, approx. 1 kg ¹ |  ² | 80–85 ⁴ | 2 | 80–90 | 45–48 |
| Sirloin joint, “medium”, approx. 1 kg ¹ |  ² | 90–95 ⁴ | 2 | 110–120 | 54–57 |
| Sirloin joint, “well done”, approx. 1 kg ¹ |  ² | 95–100 ⁴ | 2 | 130–140 | 63–66 |
| Burgers, patties ^{*1} |  | 250 | 4 | 15–25 ⁸ | -- |

 Function,  Temperature,  ⁵₁ Shelf level  Cooking duration,  Core temperature,  Fan plus,  Conventional heat,  Eco fan heat,  Full grill

* The settings also apply for testing in accordance with EN 60350-1.

¹ Use the rack and universal tray.

² Sear the meat on the hob first.

³ Pre-heat the oven before putting food inside. Do not use the  Booster function for this purpose.

⁴ Pre-heat the oven at 120 °C for 15 minutes. Do not use the  Booster function for this purpose. Reduce the temperature when you place the food in the oven.

⁵ Pre-heat the oven for 5 minutes before putting food inside. Do not use the  Booster function for this purpose.















⁶ Roast with the lid on first. Then remove the lid after roasting for 90 minutes and add approx. 0.5 litres of liquid.







⁷ Roast with the lid on first. Then remove the lid after roasting for 100 minutes and add approx. 0.5 litres of liquid.



⁸ Turn the food halfway through cooking.

⁹ If you have a separate food probe you can use the core temperature shown.

Veal

















| Food (accessories) |  |  [°C] |  |  5 3 1 |  [min] |  ⁶ [°C] |
|--|--|--|---|--|---|---|
| Braised veal, approx. 1.5 kg (oven dish with lid) |  ² | 160–170 ³ | ✓ | 2 | 120–130 ⁵ | -- |
| |  ² | 170–180 ³ | ✓ | 2 | 120–130 ⁵ | -- |
| Fillet of veal, approx. 1 kg (universal tray) |  ² | 160–170 ³ | ✓ | 2 | 30–60 | 45–75 |
| Fillet of veal, “rare”, approx. 1 kg ¹ |  ² | 80–85 ⁴ | – | 2 | 50–60 | 45–48 |
| Fillet of veal, “medium”, approx. 1 kg ¹ |  ² | 90–95 ⁴ | – | 2 | 80–90 | 54–57 |
| Fillet of veal, “well done”, approx. 1 kg ¹ |  ² | 95–100 ⁴ | – | 2 | 90–100 | 63–66 |
| Saddle of veal, “rare”, approx. 1 kg ¹ |  ² | 80–85 ⁴ | – | 2 | 80–90 | 45–48 |
| Saddle of veal, “medium”, approx. 1 kg ¹ |  ² | 90–95 ⁴ | – | 2 | 100–130 | 54–57 |
| Saddle of veal, “well done”, approx. 1 kg ¹ |  ² | 95–100 ⁴ | – | 2 | 130–140 | 63–66 |

 Function,  Temperature,  ⁵ Shelf level,  Cooking duration,  ⁶ Core temperature,  Fan plus,  Conventional heat



- 1 Use the rack and universal tray.
- 2 Sear the meat on the hob first.
- 3 Pre-heat the oven before putting food inside. Do not use the  Booster function for this purpose.
- 4 Pre-heat the oven at 120 °C for 15 minutes. Do not use the  Booster function for this purpose. Reduce the temperature when you place the food in the oven.
- 5 Roast with the lid on first. Then remove the lid after roasting for 90 minutes and add approx. 0.5 litres of liquid.
- 6 If you have a separate food probe you can use the core temperature shown.

Cooking charts













Pork







| Food (accessories) |  |  [°C] |  ⁵ |  [min] |  ⁹ [°C] |
|---|--|--|--|---|--|
| Pork joint/pork neck roast, approx. 1 kg (oven dish with lid) |  | 160–170 | 2 | 130–140 ⁵ | 80–90 |
| |  | 170–180 | 2 | 130–140 ⁵ | 80–90 |
| Pork joint with crackling, approx. 2 kg (oven dish) |  | 180–190 | 2 | 130–150 ⁶ | 80–90 |
| |  | 190–200 | 2 | 130–150 ⁶ | 80–90 |
| Fillet of pork, approx. 350 g ¹ |  ² | 90–100 ³ | 2 | 70–90 | 60–69 |
| Ham roast, approx. 1.5 kg (oven dish with lid) |  | 160–170 | 2 | 130–160 ⁷ | 80–90 |
| Gammon joint, approx. 1 kg (universal tray) |  | 150–160 | 2 | 50–60 | 63–68 |
| Gammon joint, approx. 1 kg ¹ |  ² | 95–105 ³ | 2 | 140–160 | 63–66 |
| Meat loaf, approx. 1 kg (universal tray) |  | 170–180 | 2 | 60–70 ⁶ | 80–85 |
| |  | 190–200 | 2 | 70–80 ⁶ | 80–85 |
| Bacon ¹ |  | 250 ⁴ | 4 | 3–5 | -- |
| Sausage ¹ |  | 250 ⁴ | 3 | 8–15 ⁸ | -- |



 Function,  Temperature, ⁵ Shelf level  Cooking duration, ⁹ Core temperature,  Fan plus,  Conventional heat,  Eco fan heat,  Full grill

- 1 Use the rack and universal tray.
- 2 Sear the meat on the hob first.
- 3 Pre-heat the oven at 120 °C for 15 minutes. Do not use the  Booster function for this purpose. Reduce the temperature when you place the food in the oven.
- 4 Pre-heat the oven for 5 minutes before putting food inside. Do not use the  Booster function for this purpose.
- 5 Roast with the lid on first. Then remove the lid after roasting for 60 minutes and add approx. 0.5 litres of liquid.
- 6 Add approx. 0.5 litres of liquid halfway through the cooking duration.
- 7 Roast with the lid on first. Then remove the lid after roasting for 100 minutes and add approx. 0.5 litres of liquid.
- 8 Turn the food halfway through cooking.
- 9 If you have a separate food probe you can use the core temperature shown.

Lamb, game















| Food (accessories) |  |  [°C] |  |  5 3 1 |  [min] |  ⁵ [°C] |
|---|--|--|---|---|---|--|
| Leg of lamb on the bone, approx. 1.5 kg (oven dish with lid) |  | 170–180 | – | 2 | 100–120 ⁴ | 64–82 |
| Saddle of lamb, off the bone (universal tray) |  ¹ | 180–190 ² | ✓ | 2 | 10–20 | 53–80 |
| Saddle of lamb, off the bone (rack and universal tray) |  ¹ | 95–105 ³ | – | 2 | 40–60 | 54–66 |
| Saddle of venison, off the bone (universal tray) |  ¹ | 160–170 ² | – | 2 | 70–90 | 60–81 |
| Roebuck saddle, off the bone (universal tray) |  ¹ | 140–150 ² | – | 2 | 25–35 | 60–81 |
| Leg of wild boar, off the bone, approx. 1 kg (oven dish with lid) |  ¹ | 170–180 | – | 2 | 100–120 ⁴ | 80–90 |





 Function,  Temperature, ⁵ Shelf level,  Cooking duration,  Core temperature,  Conventional heat



- 1 Sear the meat on the hob first.
- 2 Pre-heat the oven before putting food inside. Do not use the  Booster function for this purpose.
- 3 Pre-heat the oven at 120 °C for 15 minutes. Do not use the  Booster function for this purpose. Reduce the temperature when you place the food in the oven.
- 4 Roast with the lid on first. Then remove the lid after roasting for 50 minutes and add approx. 0.5 litres of liquid.
- 5 If you have a separate food probe you can use the core temperature shown.

Cooking charts

















Poultry, fish







| Food (accessories) |  |  [°C] |  ⁵ |  [min] |  ⁶ [°C] |
|---|---|--|--|---|--|
| Poultry, 0.8–1.5 kg (universal tray) |  | 170–180 | 2 | 55–65 | 85–90 |
| Chicken, approx. 1.2 kg (rack on top of universal tray) |  | 180–190 ¹ | 2 | 55–65 ³ | 85–90 |
| Poultry, approx. 2 kg (oven dish) |  | 180–190 | 2 | 100–120 ⁴ | 85–90 |
| |  | 190–200 | 2 | 110–130 ⁴ | 85–90 |
| Poultry, approx. 4 kg (oven dish) |  | 160–170 | 2 | 180–200 ⁵ | 90–95 |
| |  | 180–190 | 2 | 180–200 ⁵ | 90–95 |
| Fish, 200–300 g (e.g. trout) (universal tray) |  | 210–220 ² | 2 | 15–25 | 75–80 |
| Fish, 1–1.5 kg (e.g. salmon trout) (universal tray) |  | 210–220 ² | 2 | 30–40 | 75–80 |
| Fish fillet in foil, 200–300 g (universal tray) |  | 200–210 | 2 | 25–30 | 75–80 |



 Function,  Temperature, ⁵ Shelf level  Cooking duration, ⁶ Core temperature,  Fan plus,  Fan grill,  Conventional heat,  Eco fan heat

- 1 Pre-heat the oven for 5 minutes before putting food inside. Do not use the  Booster function for this purpose.
- 2 Pre-heat the oven before putting food inside. Do not use the  Booster function for this purpose.
- 3 Turn the food half way through grilling.
- 4 Add approx. 0.25 litres of liquid at the start.
- 5 Add approx. 0.5 litres of liquid after 30 minutes.
- 6 If you have a separate food probe you can use the core temperature shown.

Test food acc. to EN 60350-1

| Test food (accessories) |  |  [°C] |  ⁵ ₁ |  [min] |
|---|--|--|---|--|
| Small cakes (1 baking tray ¹) |  | 150 | 2 | 25–35 |
| |  | 160 ⁴ | 3 | 20–30 |
| Small cakes (2 baking trays ¹) |  | 150 ⁴ | 2+4 | 25–35 |
| Drop cookies (1 baking tray ¹) |  | 140 | 2 | 35–45 |
| |  | 160 ⁴ | 3 | 20–30 |
| Drop cookies (2 baking trays ¹) |  | 140 | 1+3 | 35–45 ⁶ |
| Apple pie (rack ¹ , springform cake tin ² , Ø 20 cm) |  | 160 | 2 | 90–100 |
| |  | 180 | 1 | 90–100 |
| Whisked sponge (rack ¹ , springform cake tin ² , Ø 26 cm) |  | 180 | 2 | 25–35 |
| |  ³ | 150–170 ⁴ | 2 | 25–45 |
| Toast (rack ¹) |  | 250 | 3 | 5–8 |
| Burgers (rack ¹ on top of universal tray ¹) |  | 250 ⁵ | 4 | 15–25 ⁷ |

 Function,  Temperature,  ⁵₁ Shelf level,  Cooking duration,  Fan plus,  Conventional heat,  Full grill

- ¹ Only use original Miele accessories.
Remove the FlexiClip runners if fitted.
- ² Use a dark matt springform cake tin.
Place the springform cake tin centrally on the rack.
- ³ In general, if a range of temperatures is given, it is best to select the lower temperature and to check the food after the shortest cooking duration.
- ⁴ Pre-heat the oven before putting food inside. Do not use the  Booster function for this purpose.
- ⁵ Pre-heat the oven for 5 minutes before putting food inside. Do not use the  Booster function for this purpose.
- ⁶ Take the trays out of the oven early if the food is sufficiently browned before the specified cooking duration has elapsed.
- ⁷ Turn the food halfway through cooking.

Notes for test institutes

Energy efficiency class according to EN 60350-1

The energy efficiency rating is determined in accordance with EN 60350-1.

Energy efficiency rating: A+

Please observe the following when conducting testing:

- Testing is undertaken using the Eco Fan heat  function.
- Only accessories that are required for testing should be in the oven compartment during tests.

Do not use other accessories that might be available such as FlexiClip runners or catalytic enamelled panels such as side panels or roof liners.

- An important pre-condition for determining the energy efficiency rating is that the door is tightly shut during testing.

Depending on measurement devices used, the functioning of the door seal can be affected to a greater or lesser extent. This has a negative impact on the test results.

Pushing against the door will compensate for this. In certain unfavourable circumstances, suitable technical aids may also be necessary for this. This does not occur in normal use.

Data sheet for household ovens

In acc. with delegated regulation (EU) No. 65/2014 and regulation (EU) No. 66/2014

| | |
|--|---|
| MIELE | |
| Model name/identifier | H 2265-1 BP, H 2267-1 BP, H 2760 BP, H 2860 BP, H 2850 BP |
| Energy efficiency index/cavity (EEI _{cavity}) | 81,7 |
| Energy efficiency class/cavity | |
| A+++ (most efficient) to D (least efficient) | A+ |
| Energy consumption per cycle for each cavity in conventional mode | 1,10 kWh |
| Energy consumption per cycle for each cavity in fan-forced convection mode | 0,71 kWh |
| Number of cavities | 1 |
| Heat source(s) per cavity | electric |
| Volume of cavity | 76 l |
| Mass of the appliance | 47,0 kg |



United Kingdom

Miele Co. Ltd.
Fairacres, Marcham Road
Abingdon, Oxon, OX14 1TW
Tel: 0330 160 6600
Internet: www.miele.com

Australia

Miele Australia Pty. Ltd.
ACN 005 635 398
ABN 96 005 635 398
1 Gilbert Park Drive
Knoxfield, VIC 3180
Tel: 1300 464 353
Internet: www.miele.com.au

China

Miele (Shanghai) Trading Ltd.
1-3 Floor, No. 82 Shi Men Yi Road
Jing' an District
200040 Shanghai, PRC
Tel: +86 21 6157 3500
Fax: +86 21 6157 3511
E-mail: info@miele.cn
Internet: www.miele.cn

Miele (Hong Kong) Limited

41/F - 4101, Manhattan Place
23 Wang Tai Road
Kowloon Bay, Hong Kong
Tel: (852) 2610 1025
Fax: (852) 3579 1404
Email:
customerservices@miele.com.hk
Website: www.miele.hk

India

Miele India Pvt. Ltd.
Ground Floor
Copia Corporate Suites
Plot No. 9, Jasola
New Delhi - 110025
Tel: 011-46 900 000
Fax: 011-46 900 001
E-mail: customercare@miele.in
Internet: www.miele.in

Ireland

Miele Ireland Ltd.
2024 Bianconi Avenue
Citywest Business Campus
Dublin 24
Tel: (01) 461 07 10
Fax: (01) 461 07 97
E-Mail: info@miele.ie
Internet: www.miele.ie

Malaysia

Miele Sdn Bhd
Suite 12-2, Level 12
Menara Sapura Kencana
Petroleum
Solaris Dutamas No. 1
Jalan Dutamas 1
50480 Kuala Lumpur, Malaysia
Phone: +603-6209-0288
Fax: +603-6205-3768

New Zealand

Miele New Zealand Limited
IRD 98 463 631
Level 2, 10 College Hill
Freemans Bay, Auckland 1011
New Zealand
Tel: 0800 464 353
Internet: www.miele.co.nz

Singapore

Miele Pte. Ltd.
163 Penang Road
04 - 03 Winsland House II
Singapore 238463
Tel: +65 6735 1191
Fax: +65 6735 1161
E-Mail: info@miele.com.sg
Internet: www.miele.sg

South Africa

Miele (Pty) Ltd
63 Peter Place, Bryanston 2194
P.O. Box 69434, Bryanston 2021
Tel: (011) 875 9000
Fax: (011) 875 9035
E-mail: info@miele.co.za
Internet: www.miele.co.za

Taiwan

K.E. & Kingstone Co., Ltd.
6th Fl., No. 120, Sec. 2
Jianguo N. Rd.
Taipei, Taiwan
TEL: +886 2 2502-7256
FAX: +886 2 2502-3077
E-mail: kenk@kenk.com.tw
Website:
www.kenk.com.tw/ke/miele

Thailand

BHIRAJ TOWER at EmQuartier
43rd Floor Unit 4301-4303
689 Sukhumvit Road
North Klongton Sub-District
Vadhana District
Bangkok 10110, Thailand

United Arab Emirates

Miele Appliances Ltd.
Gold & Diamond Park
Office No. 6-217
Sheikh Zayed Road
P.O. Box 11 47 82 - Dubai
Tel. +971 4 3044 999
Fax. +971 4 3418 852
800-MIELE (64353)
E-Mail: info@miele.ae
Website: www.miele.ae

Manufacturer: Miele & Cie. KG, Carl-Miele-Straße 29, 33332 Gütersloh, Germany

H 2265-1 BP, H 2267-1 BP, H 2760 BP, H 2860 BP,
H 2850 BP