

## Operating and installation instructions Oven



To avoid the risk of accidents or damage to the appliance it is **essential** to read these instructions before it is installed and used for the first time.

# Contents

---

<b>Warning and safety instructions</b> .....	6
<b>Caring for the environment</b> .....	15
<b>Guide to the appliance</b> .....	16
<b>Controls</b> .....	17
On/Off sensor control .....	18
Movement sensor .....	18
Sensor controls .....	19
Touch display .....	20
Symbols .....	21
<b>Using the appliance</b> .....	22
Selecting a menu option .....	22
Scrolling .....	22
Exiting a menu .....	22
Changing a value or setting .....	22
Changing a setting in a list .....	22
Entering numbers with the roller .....	22
Entering numbers using the numerical keypad .....	22
Changing the setting with a segment bar .....	22
Entering letters .....	23
Displaying the context menu .....	23
Moving entries .....	23
Displaying the pull-down menu .....	24
Displaying Help .....	24
Activating MobileStart .....	24
<b>Features</b> .....	25
Data plate .....	25
Scope of delivery .....	25
Accessories supplied and available to order .....	25
Functions .....	31
Safety features .....	31
PerfectClean treated surfaces .....	32
Pyrolytic accessories .....	32
<b>Before using for the first time</b> .....	33
Miele@home .....	33
Basic settings .....	34
Heating up the oven for the first time and rinsing the steam injection system .....	35
<b>Settings</b> .....	37
Settings overview .....	37
Opening the “Settings” menu .....	40
Language  .....	40

---

Time.....	40
Date.....	41
Lighting.....	41
Start screen.....	41
Display.....	42
Volume.....	42
Units.....	43
Booster.....	43
Rapid cooling.....	43
Keeping warm.....	44
Recommended temperatures.....	44
Pyrolytic.....	44
Cooling fan run-on.....	45
Camera in oven.....	45
Proximity sensor (movement sensor).....	46
Safety.....	47
Furniture front recognition.....	47
Miele@home.....	48
Remote control.....	49
Activating MobileStart.....	49
SuperVision.....	49
RemoteUpdate.....	50
Software version.....	51
Legal information.....	51
Showroom programme.....	51
Factory default.....	51
<b>Alarm + minute minder.....</b>	<b>52</b>
Using the Alarm function.....	52
Using the Minute minder function.....	53
<b>Main and sub-menus.....</b>	<b>54</b>
<b>Energy saving tips.....</b>	<b>56</b>
<b>Operation.....</b>	<b>58</b>
Changing values and settings for a cooking programme.....	58
Changing the temperature and core temperature.....	58
Setting cooking durations.....	59
Changing the set cooking durations.....	59
Deleting the set cooking durations.....	60
Cancelling a cooking programme.....	60
Pre-heating the oven compartment.....	60
Booster.....	61
Pre-heat.....	61

# Contents

---

Rapid cooling .....	62
Keeping warm .....	63
Crisp function .....	64
Changing the function .....	64
<b>Moisture plus</b> .....	65
Starting a cooking programme with Moisture plus .....	66
Evaporate residual moisture .....	69
<b>Automatic programmes</b> .....	71
Categories .....	71
Using automatic programmes .....	71
Handy hints .....	71
Search .....	72
<b>Special applications</b> .....	73
Defrost .....	73
Drying .....	74
Heat crockery .....	75
Prove dough .....	75
Keeping warm .....	75
Low temp. cooking.....	76
Frozen food/Ready meals.....	78
<b>MyMiele</b> .....	79
<b>User programmes</b> .....	80
<b>Baking</b> .....	83
Tips on baking.....	83
Notes on the cooking charts .....	83
Notes on the functions .....	84
<b>Roasting</b> .....	85
Tips for roasting .....	85
Notes on the cooking charts .....	85
Notes on the functions .....	86
Food probe .....	87
How it works.....	87
<b>Grilling</b> .....	91
Tips for grilling.....	91
Notes on the cooking charts .....	91
Notes on the functions .....	92
<b>Cleaning and care</b> .....	93
Unsuitable cleaning agents.....	93
Removing normal soiling .....	94
Removing stubborn soiling (excluding the FlexiClip runners) .....	95

Pyrolytic cleaning of the oven compartment.....	96
Descale.....	99
Door removal.....	103
Dismantling the door.....	104
Fitting the door.....	108
Removing the side runners with FlexiClip runners.....	109
Lowering the top heat/grill element.....	110
<b>Problem solving guide</b> .....	111
<b>Service</b> .....	117
Contact in case of malfunction .....	117
Warranty .....	117
<b>Installation</b> .....	118
Installation dimensions.....	118
Installation in a tall or base unit.....	118
Side view .....	119
Connections and ventilation.....	120
Installing the oven .....	121
Electrical connection.....	122
Oven.....	122
Electrical connection: Other countries .....	123
<b>Cooking charts</b> .....	124
Batter.....	124
Rubbed in mixture.....	125
Yeast dough .....	126
Quark dough.....	127
Sponge mixture .....	127
Choux pastry, puff pastry, meringue.....	128
Savoury dishes.....	129
Beef .....	130
Veal.....	131
Pork .....	132
Lamb, game .....	133
Poultry, fish.....	134
<b>Notes for test institutes</b> .....	135
Test food acc. to EN 60350-1 .....	135
Energy efficiency class according to EN 60350-1.....	136
Data sheet for household ovens .....	136
<b>Conformity declaration</b> .....	137
<b>Copyrights and Licences</b> .....	138

## Warning and safety instructions

---

This oven complies with all current local and national safety requirements. However, inappropriate use can lead to personal injury and damage to property.

Read the operating and installation instructions carefully before using the oven. They contain important information on safety, installation, use and maintenance. This prevents both personal injury and damage to the oven.

In accordance with standard IEC/EN 60335-1, Miele expressly and strongly advises that you read and follow the instructions in the chapter on installing the oven as well as the safety instructions and warnings.

Miele cannot be held liable for damage caused by non-compliance with these instructions.

Keep these instructions in a safe place and pass them on to any future owner.

## Appropriate use

- ▶ This oven is intended for domestic use and use in other similar environments.
- ▶ The oven is not intended for outdoor use.
- ▶ The oven is intended for domestic use only to bake, roast, grill, cook, defrost and dry food.  
All other types of use are not permitted.
- ▶ This oven may only be used by people with reduced physical, sensory or mental capabilities or lack of experience and knowledge if they are supervised whilst using it.  
They may only use it unsupervised if they have been shown how to use it in a safe manner. They must be able to recognise and understand the dangers of misuse.
- ▶ The oven compartment is equipped with special lamps to cope with particular conditions (e.g. temperature, moisture, chemical resistance, abrasion resistance and vibration). These special lamps must only be used for the purpose for which they are intended. They are not suitable for room lighting. Replacement lamps may only be fitted by a Miele authorised technician or by the Miele Customer Service Department.

# Warning and safety instructions

---

## Safety with children

- ▶ Children under 8 years of age must be kept away from the oven unless they are constantly supervised.
- ▶ Children aged 8 and older may only use the oven without supervision if they have been shown how to use it in a safe manner. Children must be able to understand and recognise the possible dangers caused by incorrect operation.
- ▶ Children must not be allowed to clean or maintain the oven unsupervised.
- ▶ Children should be supervised in the vicinity of the oven. Never allow children to play with the oven.
- ▶ Risk of suffocation due to packaging material. Whilst playing, children may become entangled in packaging material (such as plastic wrapping) or pull it over their head, presenting the risk of suffocation.

Keep packaging material away from children.

- ▶ Risk of injury caused by hot surfaces. Children's skin is far more sensitive to high temperatures than that of adults. External parts of the oven such as the door glass, control panel and the vent become quite hot. Do not let children touch the oven when it is in operation.

- ▶ Danger of injury caused by hot surfaces. Children's skin is far more sensitive to high temperatures than that of adults. The oven gets much hotter during pyrolytic cleaning than during normal use. Do not let children touch the oven during pyrolytic cleaning.

- ▶ Risk of injury from the open door.

The oven door can support a maximum weight of 15 kg. Children could injure themselves on an open door.

Do not let children sit on the open door, lean against it or swing on it.

- ▶ If you touch the  sensor control, the door will fully open automatically. In doing so, it can knock against small children or animals, for example. When opening the door, make sure that nobody is in the area around the door.



## Technical safety



- ▶ Unauthorised installation, maintenance and repairs can cause considerable danger for the user. Installation, maintenance and repairs must only be carried out by a Miele authorised technician.
- ▶ Damage to the oven can compromise your safety. Check the oven for visible signs of damage. Do not use a damaged oven.
- ▶ Reliable and safe operation of this oven can only be assured if it has been connected to the mains electricity supply.
- ▶ The electrical safety of this oven can only be guaranteed when correctly earthed. It is most important that this basic safety requirement is fulfilled. If in doubt, the electrical installation should be checked by a qualified electrician.
- ▶ The connection data (voltage and frequency) on the data plate of the oven must match the mains electricity supply in order to avoid the risk of damage to the oven. Compare this before connecting the appliance to the mains. If in any doubt, consult a qualified electrician.
- ▶ Multi-socket adapters and extension leads do not guarantee the required safety of the appliance. Do not use these to connect the oven to the mains electricity supply.
- ▶ For safety reasons, the oven may only be used when it has been fully installed.
- ▶ The oven must not be used in a non-stationary location (e.g. on a ship).
- ▶ Risk of injury due to electric shock. Any contact with live connections or tampering with the electrical or mechanical components of the oven will endanger your safety and may lead to the oven malfunctioning.  
Do not open the oven housing under any circumstances.
- ▶ While the oven is under warranty, repairs should only be undertaken by a Miele authorised service technician. Otherwise the warranty will be invalidated.

## Warning and safety instructions

---



- ▶ Miele can only guarantee the safety of the oven when original Miele spare parts are used. Faulty components must only be replaced by original spare parts.
- ▶ If the oven is delivered without a power connection cable, a special cable must be installed by a Miele authorised service technician (see “Installation”, “Electrical connection”).
- ▶ If the connection cable is damaged, it must be replaced with a special connection cable by a Miele authorised service technician (see “Installation”, “Electrical connection”).
- ▶ During installation, maintenance and repair work, the oven must be completely disconnected from the mains electricity supply. To ensure this:
  - disconnect the mains fuse, or
  - completely unscrew the screw-out fuse (in countries where this is applicable), or
  - pull out the plug (if one is present) at the wall socket. To do this, pull the plug and not the mains connection cable.
- ▶ The oven requires a sufficient supply of cool air for efficient operation. Make sure that the supply of cool air is not hindered in any way (e.g. by fitting heat insulation strips in the housing unit). Furthermore, the required supply of cool air must not be excessively heated by other heat sources (e.g. solid fuel stoves).
- ▶ If the oven is built in behind a furniture front (e.g. a door), do not close the furniture door while the oven is in use. Heat and moisture can build up behind the closed furniture door. This can result in damage to the oven, housing unit and floor. Leave the furniture front/door open until the oven has cooled down completely.

## Correct use

- ▶ Risk of injury caused by hot surfaces. The oven gets hot during operation. You could burn yourself on the heating elements, oven compartment, accessories or food.  
Wear oven gloves when placing hot food in the oven or removing it and when adjusting oven shelves, for example, in a hot oven compartment.
- ▶ Due to the high temperatures radiated, objects left near the oven could catch fire. Do not use the oven to heat up the room.
- ▶ Oils and fats can ignite if allowed to overheat. Never leave the oven unattended when cooking with oil or fats. Never attempt to put out oil or fat fires with water. Switch the oven off and extinguish the flames by leaving the door closed.
- ▶ Grilling food for excessively long cooking durations can cause it to dry out with the risk of catching fire. Do not exceed the recommended cooking durations.
- ▶ Certain foods dry out quickly and may catch fire due to high grill temperatures.  
Never use grill modes to finish baking partially baked rolls or bread or to dry flowers or herbs. Instead, use the Fan plus  or Conventional heat  function.
- ▶ If using alcohol in your recipes, please be aware that high temperatures can cause the alcohol to evaporate. The vapour can catch fire on hot heating elements.
- ▶ When using residual heat to keep food warm, corrosion from high air humidity and condensation can occur in the oven. This can also cause damage to the control panel, worktop and surrounding kitchen furniture. Keep the oven on and select the lowest temperature available for the selected function. The cooling fan will then continue to run automatically.

## Warning and safety instructions

---

- ▶ Food which is stored in the oven compartment or left in it to be kept warm can dry out and the moisture released can lead to corrosion damage in the oven. Always cover food that is left in the oven to keep warm.
- ▶ An accumulation of heat can cause the enamel on the floor of the oven to crack or flake off.  
Never line the floor of the oven compartment with aluminium foil or oven liners.  
If you wish to place crockery on the floor of the oven compartment during cooking, or place crockery on the floor of the oven compartment to heat it up, you can do so, but only with the Fan plus  or Eco Fan heat  function, without the Booster function.
- ▶ The oven compartment floor can become damaged by items being pushed around on it. When placing pots, pans or crockery on the oven compartment floor, ensure that you avoid pushing them around.
- ▶ Risk of injury caused by steam. Pouring a cold liquid onto a hot surface creates steam, which can cause severe scalding. The sudden temperature change can also cause damage to hot enamelled surfaces. Never pour cold liquids directly onto hot enamelled surfaces.
- ▶ Danger of injury caused by steam. During cooking processes using moisture and during the residual moisture evaporation process steam is produced which can cause serious injury by scalding. Never open the door while steam is being injected or during the evaporation of residual water.
- ▶ It is important that the temperature in the food being cooked is evenly distributed and sufficiently high. This can be achieved by stirring or turning the food.
- ▶ Plastic dishes that are not suitable for use in an oven will melt and may ignite at high temperatures, and can damage the oven. Use only plastic containers that are suitable for use in an oven. Follow the manufacturer's instructions.

## Warning and safety instructions

---

- ▶ Heating up food in closed containers, such as tins or sealed jars, will result in an increase in pressure, which can cause them to explode. Do not heat up unopened tins or jars of food in the oven.
- ▶ Risk of injury from the open door. You could bang into the open door or trip over it. Avoid leaving the door open unnecessarily.
- ▶ The door can support a maximum load of 15 kg. Do not lean or sit on an open door, or place heavy items on it. Make sure that nothing gets trapped between the door and the oven compartment. This could damage the oven.

### **The following applies to stainless steel surfaces:**

- ▶ Adhesives will damage the stainless steel surface and cause it to lose its dirt-repellent protective coating. Do not use sticky notes, adhesive tape or other types of adhesive on the stainless steel surface.
- ▶ Magnets can cause scratches. Do not use the stainless steel surface as a magnetic notice board.

### **Cleaning and care**

- ▶ Risk of injury due to electric shock. The steam from a steam cleaning appliance could reach live electrical components and cause a short circuit. Do not use a steam cleaner to clean the appliance.
- ▶ Scratches on the door glass can cause the glass to break. Do not use abrasive cleaners, hard sponges, brushes or sharp metal tools to clean the door glass.
- ▶ The side runners can be removed (see “Cleaning and care” – “Removing the side runners with FlexiClip runners”). Refit the side runners correctly.
- ▶ Coarse soiling in the oven compartment can cause thick smoke to develop. Coarse soiling should be removed from the oven compartment before running the pyrolytic cleaning programme.

## Warning and safety instructions

---

▶ In warm, moist environments, there is a higher probability of pest infestations (such as cockroaches). Ensure the oven and the area surrounding it are always kept clean.

Damage caused by pests is not covered by the warranty.

### Accessories

▶ Only use original Miele accessories. If other parts are used, warranty, performance and product liability claims will be invalidated.

▶ The Miele gourmet oven dish HUB 5000/HUB 5001 (if available) must not be inserted into shelf level 1. This will damage the floor of the oven. The lack of clearance will create an accumulation of heat which can cause the enamel to crack or flake off. Never place a Miele oven dish on the upper support of shelf level 1 either as it will not be secured by the non-tip safety notches. As a general rule, use shelf level 2.

▶ Only use the Miele food probe supplied with the appliance. If it is faulty, it must be replaced with a new original Miele food probe.

▶ The plastic on the food probe can melt at very high temperatures. Do not use the food probe when using the grill functions. Do not store the food probe in the oven compartment when it is not being used.

▶ Accessories that are not suitable for pyrolytic cleaning will be damaged by the high temperatures. Remove all accessories that are not suitable for pyrolytic cleaning from the oven compartment before starting the pyrolytic cleaning programme. This also applies to optional accessories that are not suitable for pyrolytic cleaning (see “Cleaning and care”).

### Disposal of the packing material

The packaging is designed to protect the appliance from damage during transportation. The packaging materials used are selected from materials which are environmentally friendly for disposal and should be recycled.

Recycling the packaging reduces the use of raw materials in the manufacturing process and also reduces the amount of waste in landfill sites.

### Disposing of your old appliance

Electrical and electronic appliances often contain valuable materials. They also contain specific materials, compounds and components, which were essential for their correct function and safety. These could be hazardous to human health and to the environment if disposed of with your domestic waste or if handled incorrectly. Please do not, therefore, dispose of your old appliance with your household waste.



Please dispose of it at your local community waste collection / recycling centre for electrical and electronic appliances, or contact your dealer or Miele for advice. You are also responsible (by law, depending on country) for deleting any personal data that may be stored on the appliance being disposed of. Please ensure that your old appliance poses no risk to children while being stored prior to disposal.

# Guide to the appliance



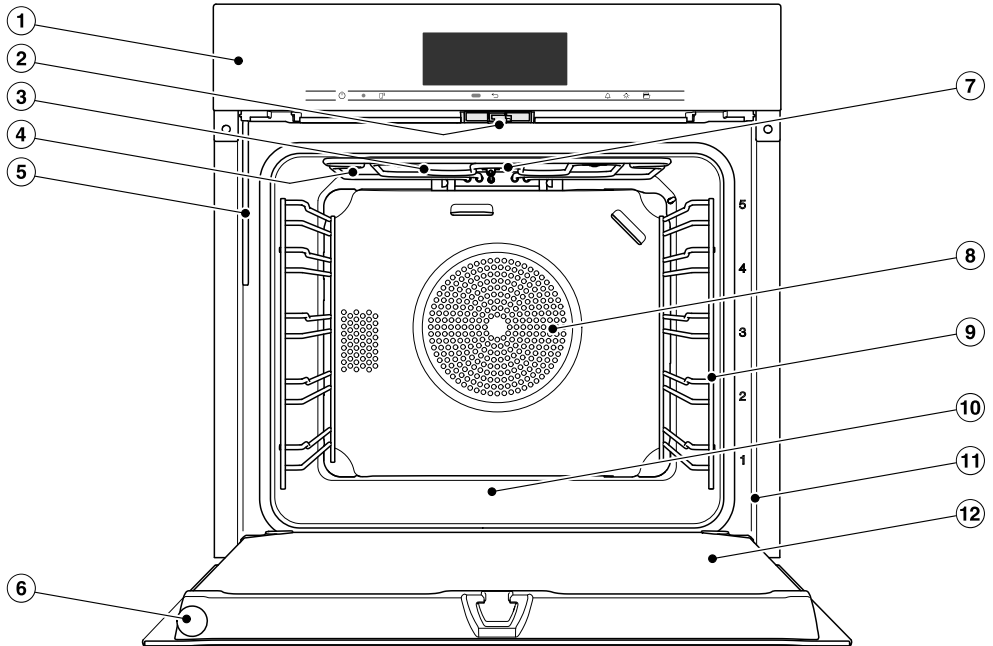

## Oven

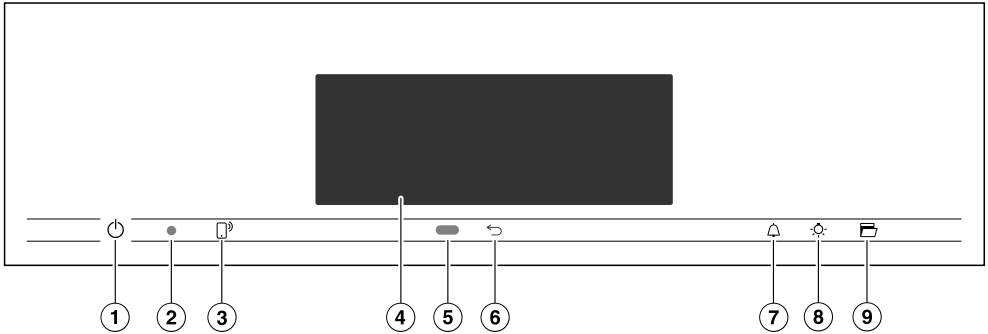

- ① Control elements
- ② Door lock
- ③ Top heat/grill element with wireless food probe antenna
- ④ Steam inlet openings
- ⑤ Water intake pipe for the steam injection system
- ⑥ Wireless food probe
- ⑦ Camera
- ⑧ Air inlet for the fan with ring heating element behind it
- ⑨ Side runners with 5 shelf levels
- ⑩ Oven floor with bottom heat element underneath it
- ⑪ Front frame with data plate
- ⑫ Door





- ① Recessed ① On/Off sensor control  
For switching the oven on and off
- ② Optical interface  
(For Miele Service only)
- ③  sensor control  
For controlling the oven via your mobile device
- ④ Touch display  
For displaying information and for operation
- ⑤ Movement sensor  
For switching on the oven interior lighting and the display, and to acknowledge the buzzer when movement is detected
- ⑥  sensor control  
To go back a step
- ⑦  sensor control  
For setting the minute minder or alarms
- ⑧  sensor control  
For switching the oven interior lighting on and off
- ⑨  sensor control  
For opening the door

# Controls

---

## On/Off sensor control

The ① On/Off sensor control is recessed and reacts to touch.

Use this sensor control to switch the oven on and off.

## Movement sensor





The movement sensor is located under the touch display next to the ↵ sensor control. The movement sensor detects when you approach the touch display, e.g. with your hand or body.

If you have activated the corresponding settings, you can switch on the oven interior lighting, switch on the oven or acknowledge the buzzers (see “Settings – Proximity sensor (movement sensor)”).

## Sensor controls

The sensor controls react to touch. Every touch of a sensor control is confirmed with an audible tone. This audible tone can be switched off by selecting the **Volume | Keypad tone | Off** setting.

If you want the sensor controls to respond even when the oven is switched off, select the **Display | QuickTouch | On** setting.

Sensor control	Function
	<p>If you want to control the oven from your mobile device, you must have the Miele@home system, switch on the <b>Remote control</b> setting and touch this sensor control. The sensor control then lights up and the <b>MobileStart</b> function is available.</p> <p>As long as this sensor control is lit, you can control the oven via your mobile device (see “Settings – Miele@home”).</p>
	<p>Depending on which menu you are in, this will take you back a level or back to the main menu.</p>
	<p>If a menu appears in the display or if a cooking programme is in progress, you can use this sensor control to set a minute minder (e.g. when boiling eggs) or an alarm (a specific time) at any point (see “Alarm and minute minder”).</p>
	<p>Select this sensor control to switch the oven interior lighting on and off.</p> <p>Depending on the setting selected, the oven interior lighting switches off after 15 seconds or remains constantly switched on or off.</p>
	<p>Use this sensor control to open the door automatically. To close it, press against the door frame with your hand or with a suitable pot holder or oven glove until the door shuts.</p>

# Controls

## Touch display

The sensitive surface of the touch display can be scratched by pointed or sharp objects, e.g. pens.

Only touch the display with your fingers.

Make sure that water cannot get behind the touch display.

The touch display is split into multiple areas.

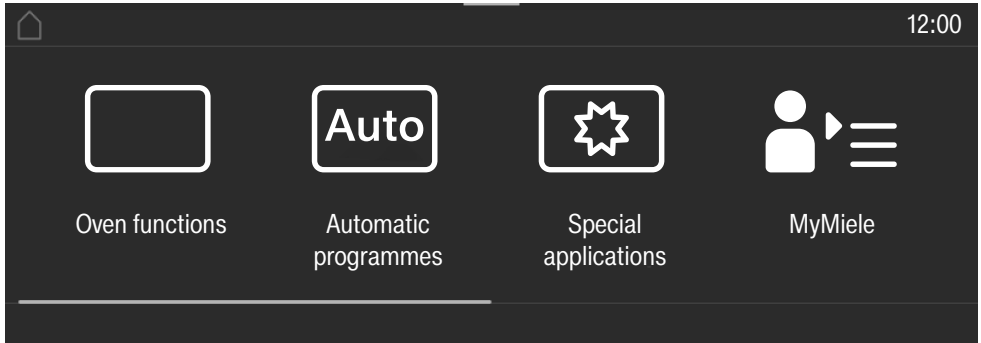

The menu path appears on the left of the **header**. The individual menu options are separated by a vertical line. ... I indicates that there are more options available, which are not visible because there is not enough space in the display.

If you touch a menu name in the header, the display will switch to that menu. To switch to the status display, touch .

The time of day is shown on the right of the header. You can set the time of day by touching the display.

Additional symbols may also appear, e.g. SuperVision .

At the top of the header there is an orange line where you can drag down the pull-down menu. This allows you to switch settings on or off during a cooking programme.

The current menu and menu options are shown in the **centre**. You can scroll to the right or left by swiping your finger across the display to the right or left. Touch a menu option to select it (see "Operation").

The operation fields that appear in the **footer** vary according to the menu that is selected; for example: Timer, Save or OK.

## Symbols

The following symbols may appear in the display:

Symbol	Meaning
	This symbol indicates that there is additional information and advice about using the appliance. Select <b>OK</b> to access the information.
	This indicates that there are more options available, which are not visible because there is not enough space in the display.
	Alarm
	Minute minder
	Some settings, e.g. display brightness and buzzer volume are selected using a bar chart.
	The system lock or sensor lock is on (see “Settings – Safety”). The controls are locked.
	Core temperature when using the food probe
	Remote control (only appears if you are in the Miele@home system and have selected the <b>Remote control   On</b> setting)
	SuperVision (only appears if you are in the Miele@home system and have selected the <b>SuperVision   SuperVision display   On</b> setting)

# Using the appliance

---

You operate the oven via the touch display by touching the desired menu option.

Each time you touch a possible option, the relevant characters (word and/or symbol) light up **orange**.

Fields for confirming an operating step are highlighted in **green** (e.g. *OK*).

## Selecting a menu option

- Touch the field or value you want in the display.

## Scrolling

You can scroll left or right.

- Swipe across the screen. To do this, place your finger on the touch display and swipe it in the direction you want.

The bar at the bottom shows you where you are in the current menu.

## Exiting a menu

- Touch the ↩ sensor control or touch the ... I symbol in the menu path.
- Touch the ⏏ symbol to switch to the status display.

Entries made before this which have not been confirmed with *OK* will not be saved.

## Changing a value or setting

### Changing a setting in a list

The current setting is highlighted in orange.

- Touch the desired setting.

The setting is now saved. This will take you back to the previous menu.

### Entering numbers with the roller

- Swipe the roller up or down until the value you want is displayed in the centre.

- Confirm with *OK*.

The changed number is now saved.

### Entering numbers using the numerical keypad

- Tap on the value that is in the middle of the numerical keypad.

The numerical keypad will appear.

- Touch the desired numbers.

As soon as you enter a valid value, *OK* turns green.

Use the arrow to delete the last entered number.

- Confirm with *OK*.

The changed number is now saved.

### Changing the setting with a segment bar

Some settings are represented by a  bar with seven segments. If all of the segments are illuminated, the maximum value is selected.

If none of the segments are illuminated, the minimum value is selected or the setting is switched off altogether (e.g. buzzers).

- Touch the corresponding segment on the segment bar to change the setting.
- Select **On** or **Off** to switch the setting on or off.
- Confirm your selection with **OK**.

The setting is now saved. This will take you back to the previous menu.

## Entering letters

Letters are entered using a display keyboard. It is best to select short names.

- Touch the desired letters or characters.

**Tip:** You can add a line break for longer programme names using the **↵** symbol.

- Touch **Save**.

The name is now saved.

## Displaying the context menu

In some menus you can display a context menu, e.g. to rename User programmes or to move entries under **MyMiele**.

- For example, touch a User programme and keep your finger on it until the context menu opens.
- To close the context menu, touch an area of the display located outside of the menu window.

## Moving entries

You can change the order of User programmes or entries under **MyMiele**.

- For example, touch a User programme and keep your finger on it until the context menu opens.
- Select **Move**.
- Keep your finger on the highlighted field and drag it to the desired location.

# Using the appliance

---

## Displaying the pull-down menu

During a cooking programme, you can switch settings such as **Booster** or **Pre-heat** and the **WiFi** function on or off.

- Use the orange line under the header to drag the pull-down menu down.
- Select the setting you want to change.  
Active settings are highlighted in orange. Depending on the selected colour scheme, inactive settings are highlighted either in black or white (see “Settings – Display”).
- To close the pull-down menu, drag it back up to the top or touch an area of the display located outside of the menu window.

## Displaying Help

Context-sensitive help is available for certain functions. In this case, **Help** appears in the bottom line.

- Touch **Help** to display information in text and pictures.
- Touch **Close** to return to the previous menu.

## Activating MobileStart

- Select the  sensor control to activate MobileStart.

The  sensor control lights up. You can operate your oven remotely with the **Miele@mobile** app.

Directly operating the oven via the touch display takes priority over operating it via the remote control function on the app.

You can use MobileStart as long as the  sensor control is lit up.



A list of the models described in these operating and installation instructions can be found on the back page of this booklet.

## Data plate

The data plate is located on the front frame, visible when the door is open.

The data plate states the model number, the serial number as well as connection data (voltage, frequency and maximum rated load).

Please have this information to hand, should you need to contact Miele regarding any questions or problems.

## Scope of delivery

- Operating and installation instructions for using the oven
- A cookbook with recipes for the automatic programmes and other functions
- Food probe
- Opener
- Screws for securing your oven in the housing unit
- Descaling tablets and a plastic tube with suction cup for descaling the steam injection system
- Various accessories

## Accessories supplied and available to order

Features will vary depending on model.

Side runners, universal tray and wire rack (or “rack” for short) are supplied as standard with the oven.

Depending on the model, your oven may also come supplied with some of the accessories listed here.

All the accessories listed as well as the cleaning and care products are designed for Miele ovens.

These are available to order via the Miele Webshop, the Miele Customer Service Department or from your Miele dealer.

When ordering, please quote the model number of your oven and the reference number of the accessories required.

### Side runners

There are runners on the left and right of the oven compartment with shelves  for inserting accessories.

The numbers for the shelf levels are marked on the front frame.

Each level consists of 2 rails, one above the other.

The accessories (e.g. the rack) are pushed into the oven between the two rails.

The FlexiClip runners (if present) are fitted on the lower rail.

You can remove the side runners (see “Cleaning and care” – “Removing the side runners with FlexiClip runners”).

# Features

## Baking tray, universal tray and rack with non-tip notches

Baking tray HBB 71:

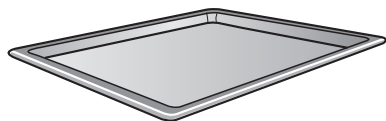

Universal tray HUBB 71:

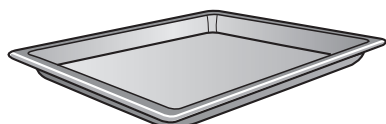

Rack HBBR 72:

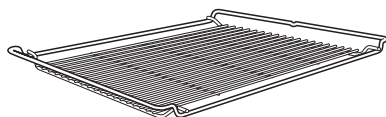

These accessories are inserted into the oven between the two rails of a shelf in the side runner.

Always place the rack with the loading surface in the lower position.

These accessories have non-tip safety notches fitted in the middle of their short sides. The non-tip safety notches prevent the trays from being pulled out completely from the side runners when you only wish to pull accessories out partially.



If you are using the universal tray with the rack on top, insert the tray between the rails of a shelf of the side runners and the rack will automatically slide in above them.

## FlexiClip runners HFC 72

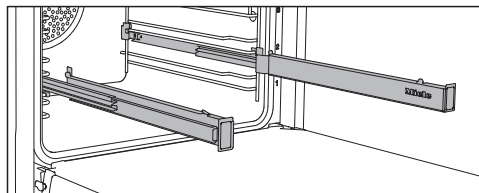

You can use the FlexiClip runners on shelf levels 1–4.

Push the FlexiClip runners right into the oven compartment before placing accessories on them.

The accessories will then automatically sit securely in between the stoppers at either end of each runner and be prevented from sliding off.

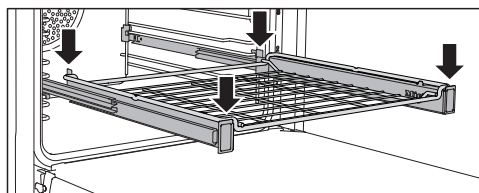
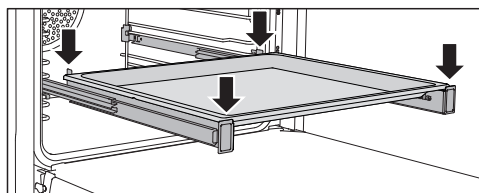

The FlexiClip runners can support a maximum load of 15 kg.

## Fitting and removing FlexiClip runners

 Danger of injury caused by hot surfaces.

The oven gets hot during operation. You could burn yourself on the heating elements, oven compartment or accessories.

Allow the heating elements, oven compartment and the accessories to cool before fitting or removing the FlexiClip runners.

The FlexiClip runners are fitted in between the two rails that make up a shelf level.

The FlexiClip runner with the Miele logo should be fitted on the right.

When fitting or removing the FlexiClip runners, **do not** extend them.

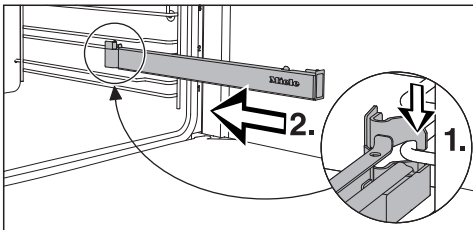

- Hook the FlexiClip runner onto the front of the lower rail of a shelf level (1.) and then push it along the rail into the oven compartment (2.).

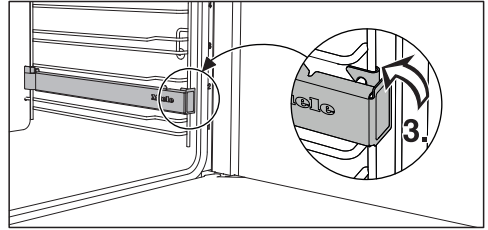

- Then secure the FlexiClip runner to the lower rail of the shelf level (3.).

If the FlexiClip runners are difficult to pull out after fitting, pull firmly on them once to release them.

To remove a FlexiClip runner, proceed as follows:

- Push the FlexiClip runner in all the way.

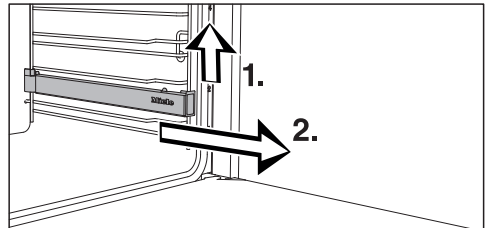

- Remove the FlexiClip runner by raising it at the front (1.) then pulling it forwards along the rail of the shelf level and out (2.).

# Features

---

## Round baking trays



The **solid round baking tray HBF 27-1** is suitable for cooking pizzas, flat cakes made with yeast or whisked mixtures, sweet and savoury tarts, baked desserts, flat bread, and can also be used for frozen cakes and pizzas.

The **perforated round baking tray HBFP 27-1** has been specially developed for baked goods made from fresh yeast and quark dough and for baking bread and rolls. The tiny perforations assist in browning the underside of baked goods.

The tray can also be used for dehydrating or drying food.

The enamelled surface of both baking trays has been treated with PerfectClean.

- Insert the rack and place the round baking tray on the rack.

## Perforated gourmet baking tray HBBL 71

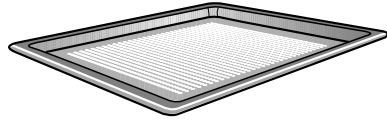

The perforated gourmet baking tray has been specially developed for the preparation of baked goods made from fresh yeast and quark doughs, as well as bread and bread rolls.

The tiny perforations assist in browning the underside of baked goods.

The gourmet baking tray can also be used for dehydrating or drying food.

The enamelled surface has been treated with PerfectClean.

The **round perforated baking tray HBFP 27-1** can be used for the same things.

## Baking stone HBS 60

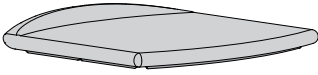

The baking stone is ideal for items which need a well baked base such as pizza, quiche, bread, bread rolls and savoury snacks.

The baking stone is made from heat-retaining fireclay and is glazed. A paddle made of untreated wood is supplied with the baking stone for placing food on it and taking it off.

- Slide the rack in and place the baking stone on it.

## Grilling and roasting insert HGBB 71

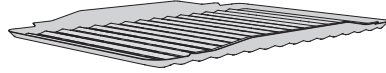

The grilling and roasting insert fits in the universal tray.

The juices from the food being grilled or roasted collect under the insert, preventing them from burning on. The juices can then be used for making gravy and sauces.

The enamelled surface has been treated with PerfectClean.

## Handle HEG

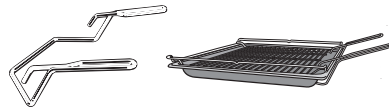

The handle makes it easier to take the universal tray, baking tray and rack out of the oven.

# Features

## HUB gourmet oven dishes HBD gourmet oven dish lids

Unlike other oven dishes, Miele gourmet oven dishes can be placed in the oven directly on the shelf runners. They have non-tip safety notches like the rack to prevent them from being pulled out too far. The surface of the oven dish has a non-stick coating.

Gourmet oven dishes are available in different depths. The width and the height are the same.

Suitable lids are available separately. Please quote the model number when ordering.

### Depth: 22 cm

HUB 5000-M  
HUB 5001-M\*

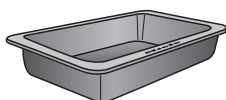

HBD 60-22

### Depth: 35 cm

HUB 5001-XL\*

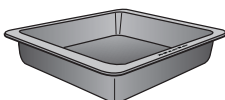

HBD 60-35

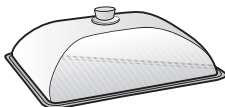
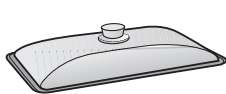

\* Suitable for use on induction hobs

## Food probe

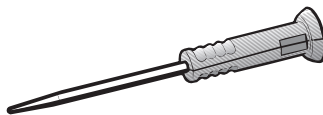

Your oven is supplied with a wireless food probe which enables the temperature during the cooking process to be monitored simply and accurately (see “Roasting” – “Food probe”). The food probe is stored in a holder in the door when not in use.

The food probe could be damaged when the oven door is closed if it is not pushed right into its holder. Replace the food probe all the way into its holder after each use.

## Accessories for cleaning and care

- Opener  
The opener can be used to lever the door open during a power cut. To do so, push the opener at an angle into the gap on the outside edge of the door at the top between the fascia panel and the door.
- Descaling tablets, plastic tube with suction cup for descaling the oven
- Miele all-purpose microfibre cloth
- Miele oven cleaner

## Functions

- Using the different functions for baking, roasting and grilling
- Clock display
- Alarm and minute minder
- Switching cooking programmes on and off automatically
- Moisture plus cooking
- Selecting custom settings
- Using automatic programmes
- Creating User programmes

## Safety features

- **System lock**   
(see “Settings – Safety”)
- **Sensor lock**  
(see “Settings – Safety”)
- **Cooling fan**  
(see “Settings – Cooling fan run-on”)
- **Safety switch-off**  
This safety switch-off is activated automatically if the oven has been operating for an unusually long period of time. The period of time will depend on the particular oven function being used.
- **Ventilated door**  
The oven door is made of glass panes that have a heat-reflective coating on part of their surface. When the oven is operating, air is passed through the door to keep the outer pane cool.  
The door can be removed and disassembled for cleaning purposes (see “Cleaning and care”).
- **Door locking** for pyrolytic cleaning  
At the beginning of a pyrolytic cleaning programme the door will lock for safety reasons. The door will only be unlocked when the temperature in the oven compartment has dropped to below 280 °C.

# Features

---

## PerfectClean treated surfaces

PerfectClean surfaces have very good non-stick properties and are exceptionally easy to clean.

Food can be easily removed from these surfaces. Soiling from baking and roasting can be easily removed from these surfaces.

Food can be sliced or cut up on PerfectClean surfaces.

However, do not use ceramic knives as these will scratch the PerfectClean surface.

Surfaces treated with PerfectClean enamel can be cleaned as you would clean glass.

Read the instructions in “Cleaning and care” so that the benefits of the non-stick properties and easy cleaning are retained.

PerfectClean treated surfaces:

- Universal tray
- Baking tray
- Grilling and roasting insert
- Perforated gourmet baking tray
- Round perforated baking tray
- Round baking tray

## Pyrolytic accessories

See “Cleaning and care” for more information.

The following accessories can be left in the oven compartment during the pyrolytic cleaning programme:

- Side runners
- FlexiClip runners HFC 72
- Rack



# Before using for the first time

## Miele@home

Your oven is equipped with an integrated WiFi module.

In order to use it, you will need:

- A WiFi network
- The Miele@mobile app
- A Miele user account The user account can be created via the Miele@mobile app.

The Miele@mobile app will guide you as you connect your oven to your home WiFi network.

Once your oven is connected to your WiFi network, you can use the app, for example, to carry the following activities:

- Call up information on the operating status of your oven
- Retrieve information on oven cooking programmes that are in progress
- End cooking programmes that are in progress

Connecting your oven to your WiFi network will increase energy consumption, even when the oven is switched off.

Make sure that the signal of your WiFi network is sufficiently strong in the place where your oven is installed.

## Availability of the WiFi connection

The WiFi connection shares a frequency range with other appliances (including microwave ovens and remote control toys). This can give rise to sporadic or even complete connection failures. Therefore, the availability of featured functions cannot be guaranteed.

## Miele@home availability

The ability to use the Miele@mobile app depends on the availability of the Miele@home service in your country.

The Miele@home service is not available in every country.

For information about availability, please visit [www.miele.com](http://www.miele.com).

## Miele@mobile App

The Miele@mobile App is available to download free of charge from the Apple App Store® or from the Google Play Store™.



# Before using for the first time

---

## Basic settings

The following settings must be made before starting up for the first time. You can change these settings again at a later time (see “Settings”).

 Risk of injury caused by hot surfaces.

The oven gets hot during operation. For safety reasons, the oven may only be used when it has been fully installed.

The oven will switch on automatically when it is connected to the electricity supply.

## Setting the language

- Select the desired language.

If you have selected the wrong language by mistake, proceed as described in “Settings –  Language”.

## Setting the country

- Select the desired country.

## Setting up Miele@home

Set up Miele@home? will appear in the display.

- To set up Miele@home now, select Continue.
- To set it up at a later date, select Skip. See “Settings – Miele@home” for information on setting up at a later date.
- To set up Miele@home now, select the desired connection method.

You will then be guided by the display and the Miele@mobile app.

## Setting the date

- Set the day, then the month, and finally the year.
- Confirm with OK.

## Setting the time

- Set the time of day in hours and minutes.
- Confirm with OK.

## Completing the commissioning process

- Follow any further instructions in the display.

The oven is now ready for use.

## Before using for the first time



### Heating up the oven for the first time and rinsing the steam injection system

When the oven is heated up for the first time it may give off an unpleasant odour. This can be eliminated by heating the empty oven for at least an hour. It is a good idea to rinse out the steam injection system at the same time.

It is important to ensure that the kitchen is well ventilated during the heating process. Prevent the odour from escaping into other rooms.

- Remove any protective wrapping and stickers from the oven and accessories.
- Before heating the oven compartment up, wipe the interior with a damp cloth to remove any dust or bits of packaging.
- Fit the FlexiClip runners in the side runners and insert all trays and the rack.
- Turn the oven on using the On/Off .

The main menu will appear.

- Select Oven functions .
- Select Moisture plus .
- Select Moisture plus + Fan plus .

The recommended temperature will appear (160 °C).

The oven heating, lighting and cooling fan will switch on.

- Set the maximum possible temperature (250 °C).
- Select Continue.
- Select Automatic.

The prompt to draw in water then appears.

- Fill a suitable container with the required amount of fresh tap water.
- Open the door.
- Pull the water intake pipe forwards (located below the control panel on the left).

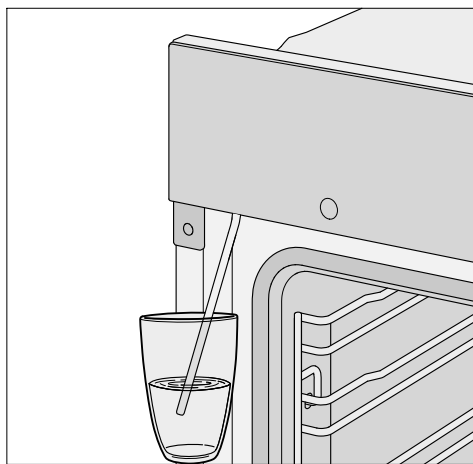

- Immerse the end of the water intake pipe in the container with the tap water.
- Confirm with OK.

The water intake process will begin.

The amount of water actually drawn up into the oven may be less than the amount specified as required, leaving a small amount in the container.

## Before using for the first time

---

- Remove the water container after the water intake process and close the door.

The sound of the pump running can be heard again briefly. Residual water in the water intake pipe is being drawn into the oven.

The oven heating, lighting and cooling fan will switch on.

After a short time a burst of steam will be released automatically.

 Danger of injury caused by steam.

The steam escaping is very hot.  
Do not open the door during steam injection.

Heat the oven for at least an hour.

- After at least an hour, switch the oven off with the  On/Off button.

## Cleaning the oven compartment after heating it up for the first time

 Danger of injury caused by hot surfaces.





The oven gets hot during operation. You could burn yourself on the heating elements, oven compartment or accessories.

Allow the heating elements, oven compartment and the accessories to cool before manual cleaning.

- Take all accessories out of the oven compartment and clean them by hand (see “Cleaning and care”).
- Clean the oven compartment with a clean sponge and a solution of hot water and washing-up liquid or a clean, damp microfibre cloth.
- Remove any residues from the cover of the camera on the top of the oven compartment.
- Dry all surfaces with a soft cloth.

Leave the oven door open until the oven compartment is completely dry.

## Settings overview

Menu option	Available settings
Language 	...   deutsch   english   ... Country
Time	Display On*   Off   Night dimming Clock type Analogue*   Digital Clock format 24 h*   12 h (am/pm) Set
Date	
Lighting	On "On" for 15 seconds* Off
Start screen	Main menu* Oven functions Automatic programmes Special applications User programmes MyMiele
Display	Brightness  Colour scheme Bright   Dark* QuickTouch On   Off*
Volume	Buzzer tones  Keypad tone  Welcome melody On*   Off
Units	Temperature °C*   °F

\* Factory default setting

# Settings

Menu option	Available settings
Booster	On* Off
Rapid cooling	On* Off
Keeping warm	On Off*
Recommended temperatures	
Pyrolytic	With reminder Without reminder*
Cooling fan run-on	Time controlled Temperature controlled*
Camera in oven	On Off*
Proximity sensor	Switch light on during cooking process*   Always on   Off Switch the appliance on On   Off* Acknowledge buzzer On*   Off
Safety	System lock  On   Off* Sensor lock On   Off*
Furniture front recognition	On Off*
Miele@home	Activate Deactivate Connection status Set up again Reset Set up
Remote control	On* Off

\* Factory default setting

Menu option	Available settings
SuperVision	SuperVision display On   Off* Display in standby On   Only if there is a fault* Appliance list Display this appliance   Buzzer tones
RemoteUpdate	On* Off
Software version	
Legal information	Open source licences
Showroom programme	Demo mode On   Off*
Factory default	Appliance settings User programmes MyMiele Recommended temperatures

\* Factory default setting

# Settings

---

## Opening the “Settings” menu

In the  Settings menu, you can personalise your oven by adapting the factory default settings to suit your requirements.

From the main menu:

- Select  Settings.
- Select the desired setting.



You can check settings or change them.

Settings cannot be changed while a cooking programme is in progress.

## Language

You can set the desired language and country.

After selecting and confirming your choice, the language you have selected will appear in the display.

**Tip:** If you have selected the wrong language by mistake, select  in the main menu. Follow the  symbol to get back to the Language  sub-menu.

## Time

### Display

Select how you want the time of day to show in the display when the oven is switched off:

- On  
The time is always visible in the display.  
If you also select the Display | QuickTouch | On setting, all sensor controls react to touch as normal and the movement sensor automatically detects when you approach the display.  
If you also select the Display | QuickTouch | Off setting, the oven has to be switched on before it can be used.
- Off  
To save energy, the display does not light up. The oven has to be switched on before it can be used.
- Night dimming  
To save energy, the time only shows in the display between 05:00 a.m. and 11:00 p.m. The display remains dark at all other times.



## Clock type

The time of day can be displayed as Analogue (with a clock face) or Digital (h:min) format.

With the digital display, the date is also shown.

## Clock format

The time of day can be displayed in the 24 or 12-hour format (24 h or 12 h (am/pm)).

## Set

Set the hours and the minutes.

**Tip:** If no cooking programme is in progress, touch the time in the header to change it.

If there is a power cut, the current time of day will reappear once power has been restored. The time of day is saved for approx. 150 hours.



If the oven has been connected to a WiFi network and signed into the Miele@mobile app, the time will be synchronised based on the country setting in the Miele@mobile app.

## Date

Set the date.

When the oven is switched off, the date will only appear in the display if the Time | Clock type | Digital setting has been selected.

## Lighting

- On  
The oven interior lighting is switched on during the entire cooking period.
- "On" for 15 seconds  
The oven interior lighting switches off 15 seconds after a cooking programme has begun. Press the  sensor control to switch the oven interior lighting on again for 15 seconds.
- Off  
The oven interior lighting is switched off. Press the  sensor control to switch on the oven interior lighting for 15 seconds.

## Start screen

The oven is factory-set for the main menu to appear when the oven is switched on. You can change this default setting so that, for instance, the oven functions or MyMiele settings appear in the status display (see "MyMiele").

This new status display will then appear when the oven is next switched on.

Select the  sensor control or follow the path in the header to get to the main menu.

# Settings

---

## Display

### Brightness

The display brightness is represented by a bar with seven segments.

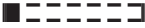
-  Maximum brightness
-  Minimum brightness

### Colour scheme

Choose between a light or dark colour scheme for the display.

- Bright  
The display has a light background with dark characters.
- Dark  
The display has a dark background with white characters.

### QuickTouch

Select how the sensor controls and the movement sensor should respond when the oven is switched off:



- On  
If you have also selected the Time | Display | On or Night dimming setting, the sensor controls and the movement sensor will also respond when the oven is switched off.
- Off  
Independently of the Time | Display setting, the sensor controls and the movement sensor only respond when the oven is switched on, as well as for a certain amount of time after switching it off.

## Volume

### Buzzer tones



If buzzers are switched on, a buzzer will sound when the set temperature is reached and at the end of a set time.

The volume of the buzzers is represented by a bar with seven segments.

-  Maximum volume
-  Buzzers are switched off

### Keypad tone

The volume of the tone that sounds each time you touch a sensor control is represented by a bar with seven segments.

-  Maximum volume
-  Tone is switched off

### Welcome melody

The melody that sounds when you touch the  On/Off sensor control can be switched on or off.

## Units

### Temperature

You can set the temperature in degrees Celsius (°C) or degrees Fahrenheit (°F).

### Booster

The **Booster** function is used to quickly pre-heat the oven compartment.

– On

The **Booster** function is automatically switched on during the heating-up phase of a cooking programme. The top heat/grill element, ring heating element and hot air fan pre-heat the oven compartment to the desired temperature at the same time.

– Off

The **Booster** function is switched off during the heating-up phase of a cooking programme. Only the heating elements associated with the function are pre-heating the oven compartment.

You can also use the pull-down menu to switch the **Booster** function on or off for a cooking programme.

## Rapid cooling

Using the **Rapid cooling** function you can quickly cool down food and the oven compartment once the cooking process is brought to an end.

This function is useful if, for example, you then immediately want to start an automatic programme for which the oven compartment needs to be cold.

Using the **Keeping warm** function you can keep food warm after cooking without inadvertently cooking it further.

– On

The **Rapid cooling** function is switched on. Once the cooking programme is brought to an end, the door opens a little automatically. The cooling fan cools the food and the oven compartment quickly.

– Off

The **Rapid cooling** function is switched off. Once the cooking process is brought to an end, the door remains closed. The cooling fan cools the food and the oven compartment.

You can also use the pull-down menu to switch the **Rapid cooling** function on or off for a cooking programme.

If your oven is installed behind a closed furniture door, follow the instructions in “Settings” – “Furniture front recognition”.

# Settings

---

## Keeping warm

Using the Keeping warm function you can keep food warm after cooking without inadvertently cooking it further. The food is kept warm at a pre-set temperature for up to 2 hours (Settings | Recommended temperatures | Keeping warm).

It is only possible to use the Keeping warm function in combination with the Rapid cooling function.

- On  
The Keeping warm function is switched on. Once the cooking programme is brought to an end, the door opens a little automatically. The cooling fan cools the food and the oven compartment quickly to the pre-set temperature. Once this temperature is reached, the door is closed again automatically in order to keep the food warm.
- Off  
The Keeping warm function is switched off. Once the cooking process is brought to an end, the door remains closed. The cooling fan cools the food and the oven compartment.

You can also use the pull-down menu to switch the Keeping warm function on or off for a cooking programme.

If your oven is installed behind a closed furniture door, follow the instructions in “Settings” – “Furniture front recognition”.

## Recommended temperatures

If you often cook with different temperatures, it makes sense to change the recommended temperatures.

After selecting this menu option, a list of functions will appear in the display.

- Select the desired function.

The recommended temperatures are displayed along with the available temperature range.

- Change the recommended temperatures.
- Confirm with OK.

You can also change the recommended temperatures for the Keeping warm function.

## Pyrolytic

You can set whether the recommendation for carrying out pyrolytic cleaning will appear (With reminder) or will not appear (Without reminder).

## Cooling fan run-on

The cooling fan will continue to run for a while after the oven has been switched off to prevent any humidity building up in the oven compartment, on the fascia panel or on the oven housing unit.

- Temperature controlled  
The cooling fan switches off when the temperature in the oven drops below 70 °C.
- Time controlled  
The cooling fan switches off after a period of about 25 minutes.

Condensate can damage the oven housing unit and the worktop and lead to corrosion in the oven.

If you have set the cooling fan to *Time controlled* and leave food in the oven compartment to keep warm, moisture levels in the oven will increase, leading to condensation forming on the fascia panel and surrounding kitchen furniture, and drops of moisture collecting under the worktop.

Do not leave food in the oven compartment to keep it warm if you have selected *Time controlled*.

## Camera in oven

If you have selected the setting *Camera in oven* | *On*, you can have images from the oven compartment sent to your mobile device during a cooking programme.

For this you will need the Miele@mobile app installed on your mobile device as well as the Miele@home system (see “Settings” – “Miele@home”).

When the door is closed, the camera takes a photo of the food on the uppermost shelf in use at regular intervals.

The oven interior lighting is switched on during the entire cooking programme to ensure the ideal image quality.

If necessary, you can change the settings for the cooking programme using the Miele@mobile app.

# Settings

---

## Proximity sensor (movement sensor)

The movement sensor detects when you approach the touch display, e.g. with your hand or body.

If you want the movement sensor to respond even when the oven is switched off, select the **Display | QuickTouch | On** setting.

### Switch light on

- during cooking process  
As soon as you approach the touch display during a cooking programme, the oven interior lighting switches on. The oven interior lighting automatically switches off again after 15 seconds.
- Always on  
As soon as you approach the touch display, the oven interior lighting switches on. The oven interior lighting automatically switches off again after 15 seconds.
- Off  
The movement sensor does not respond when you approach the touch display. Select the  sensor control to switch on the oven interior lighting for 15 seconds.

## Switch the appliance on

- On  
If the time is displayed, the oven switches on and the main menu appears as you approach the touch display.
- Off  
The movement sensor does not respond when you approach the touch display. Switch the oven on with the  On/Off sensor control.

## Acknowledge buzzer

- On  
As soon as you approach the touch display, the buzzers switch off.
- Off  
The movement sensor does not respond when you approach the touch display. Switch the buzzers off manually.

## Safety

### System lock

The system lock prevents the oven being switched on by mistake.

You can still set an alarm and a minute minder as well as use the MobileStart function when the system lock is active.

The system lock will remain activated even after a power failure.

- On  
The system lock has been activated. If you want to use the oven, switch it on and touch the  symbol for at least 6 seconds.
- Off  
The system lock is deactivated. You can use the oven as normal.

### Sensor lock

The sensor lock prevents the cooking programme being switched off by mistake or settings being changed. Apart from the  On/Off sensor control, the activated sensor lock prevents the sensor controls and fields in the display from working for a few seconds after a programme has been started.

- On  
The sensor lock is active. Touch *OK* for at least 6 seconds to deactivate the sensor lock for a short period of time.
- Off  
The sensor lock is deactivated. All sensor controls react again to touch as normal.

## Furniture front recognition

- On  
The furniture front detection is activated. Using the movement sensor, the oven automatically detects whether the furniture door is closed.  
  
If the furniture door is closed, the oven switches off automatically after a certain period.
- Off  
The furniture front detection is deactivated. The oven does not detect whether the furniture door is closed.

If the oven is installed behind a decorative furniture panel (e.g. a door), the oven, housing unit and the floor can be damaged by the build up of heat and moisture behind the closed furniture panel.  
Always leave the furniture door open when you are using the oven.  
Leave the furniture door open until the oven has cooled down completely.

# Settings

---

## Miele@home

The oven is a Miele@home-compatible appliance with SuperVision functionality.

Your oven is fitted ex-works with a WiFi communication module and is suitable for wireless communication.

There are a number of ways of connecting your oven to your WiFi network. We recommend connecting your oven to your WiFi network with the help of the Miele@mobile App or via WPS.

After installing the Miele@mobile App on a mobile device, you can do the following:

- Operate your appliance remotely
- Call up information on the operating status of your appliance
- Call up information on the programme sequence of your appliance
- Set up a Miele@home network with other Wi-Fi enabled Miele appliances

- Activate  
This setting is only visible if Miele@home is deactivated. The WiFi function is reactivated.
- Deactivate  
This setting is only visible if Miele@home is activated. Miele@home remains set up, the WiFi function is switched off.
- Connection status  
This setting is only visible if Miele@home is activated. The display shows information such as the WiFi reception quality, network name and IP address.
- Set up again  
This setting is only visible if a WiFi network has already been set up. Reset the network settings and immediately set up a new network connection.
- Reset  
This setting is only visible if a WiFi network has already been set up. The WiFi function is deactivated and the WiFi connection will be reset to the factory default setting. You must set up a new WiFi connection to be able to use Miele@home.
- Set up  
This setting is only visible if there is no existing WiFi connection. You must set up a new WiFi connection to be able to use Miele@home.



## Remote control

If you have installed the Miele@mobile app on your mobile device, have access to the Miele@home system and have activated the remote control function (On), you can use the MobileStart function to retrieve information on oven cooking programmes that are in progress or to end a programme in progress.

### Activating MobileStart

- Select the  sensor control to activate MobileStart.

The  sensor control lights up. You can operate your oven remotely with the Miele@mobile app.

Directly operating the oven via the touch display takes priority over operating it via the remote control function on the app.

You can use MobileStart as long as the  sensor control is lit up.

## SuperVision

The oven is a Miele@home-compatible appliance with SuperVision functionality for monitoring other household appliances in the Miele@home system.

The SuperVision function cannot be activated until the Miele@home system has been set up.

### SuperVision display

- On  
The SuperVision function is switched on.  
The  symbol will appear in the top right-hand side of the display.
- Off  
The SuperVision function is switched off.

### Display in standby

The SuperVision function is also available when the oven is in standby. However, the time-of-day display must be switched on (Settings | Time | Display | On).

- On  
Active household appliances that are signed into the Miele@home system are always displayed.
- Only if there is a fault  
Only faults on active household appliances are shown.

# Settings

---

## Appliance list

All household appliances signed in to the Miele@home System are shown. Once you have selected an appliance, you can access further settings:

- Display this appliance
  - On  
The SuperVision function for this appliance is switched on.
  - Off  
The SuperVision function for this appliance is switched off. The appliance is still signed on to the Miele@home system. Faults are displayed, even if the SuperVision function for the appliance has been switched off.
- Buzzer tones  
You can select whether the buzzers are switched on (On) or switched off (Off) for this appliance.

## RemoteUpdate

The RemoteUpdate menu option is only displayed and can only be selected if the requirements for using Miele@home have been met (see “Before using for the first time – Miele@home”).

The RemoteUpdate function is used for updating the software in your oven. If an update is available for your oven, it will automatically download it. Updates will not be installed automatically. They must be initiated manually.

If you do not install an update, you can continue to use your oven as usual. However, Miele recommends installing updates.

### Activating/deactivating

The RemoteUpdate function is activated as standard. Available updates will be downloaded automatically but will only be installed if you initiate installation manually.

Deactivate RemoteUpdate if you do not want any updates to be downloaded automatically.

## Running a RemoteUpdate

Information about the content and scope of an update will be provided in the Miele@mobile app.

A message will appear in your oven display if a software update is available.

You can install the update immediately or postpone this until later. When the oven is switched on again, you will be reminded about the update.

Deactivate RemoteUpdate if you do not want to install the update.

The update may take several minutes.

Please note the following information about the RemoteUpdate function:

- You will only receive a message when an update is available.
- Once an update has been installed, it cannot be undone.
- Do not switch the oven off during the update. Otherwise, the update will be aborted and will not be installed.
- Some software updates can only be carried out by the Miele Customer Service Department.

## Software version

The software version is intended for the Miele Customer Service Department. You do not need this information for domestic use.

- Confirm with *OK*.

## Legal information

You can find an overview of the integrated Open Source components under *Open source licences*.

- Confirm with *OK*.

## Showroom programme

This function enables the oven to be demonstrated in showrooms without heating up. Do not activate this setting for domestic use.

## Demo mode

If you have demo mode activated, Demo mode switched on. The appliance will not heat up will appear when you switch the oven on.

- On  
Touch *OK* for at least 4 seconds to activate demo mode.
- Off  
Touch *OK* for at least 4 seconds to deactivate demo mode. You can use the oven as normal.

## Factory default

- Appliance settings  
Any settings that have been altered will be reset to the factory default settings.
- User programmes  
All User programmes will be deleted.
- MyMiele  
All MyMiele entries will be deleted.
- Recommended temperatures  
Any recommended temperatures that have been changed will be reset to the factory default settings.

# Alarm + minute minder

---

Using the  sensor control, you can set a minute minder, e.g. for boiling eggs, or an alarm for a specific time.



Two alarms can be set simultaneously; two minute minder durations or an alarm and a minute minder duration.

## Using the Alarm function

The  alarm can be used to specify a particular time for a buzzer to sound.

### Setting the alarm

If the Display | QuickTouch | Off setting is selected, you will need to switch the oven on before setting the alarm. The alarm time will then appear in the display when the oven is switched off.

- Select the  sensor control.
- Select  Alarm.
- Set the time for the alarm.
- Touch **Close** to confirm.

When the oven is switched off, the alarm time and  will appear instead of the time of day.

If you are cooking at the same time or if you are in a different menu, the alarm time and  will appear at the top right-hand side of the display.

At the specified time for the alarm,  will flash in the display next to the time and a buzzer will sound.

- Select the  sensor control or the set alarm time in the display.

The buzzer will stop and the symbols in the display will go out.

## Changing an alarm

- Select the alarm in the display or select the  sensor control and the desired alarm.

The set alarm time appears in the display.

- Set the new time for the alarm.
- Touch **Close** to confirm.

The adjusted alarm time is now saved and will appear in the display.

## Deleting an alarm

- Select the alarm in the display or select the  sensor control and the desired alarm.

The set alarm time appears in the display.

- Select **Delete**.
- Touch **Close** to confirm.

The alarm will be deleted.

## Using the Minute minder function

The  minute minder can be used to time other activities in the kitchen, e.g. boiling eggs.

The minute minder can also be used at the same time as a cooking programme for which the cooking duration start and finish times have been set (e.g. as a reminder to stir the food or add seasoning, etc.).



- The maximum minute minder time that can be set is 59 minutes and 59 seconds.

**Tip:** When using a function that uses moisture, use the timer to remind you to inject steam manually at the desired time.

## Setting the minute minder

If you have selected the Display | QuickTouch | Off setting, you will need to switch the oven on before setting the minute minder. The minute minder can then be seen counting down in the display when the oven is switched off.

Example: you want to boil some eggs and set a minute minder duration of 6 minutes and 20 seconds.

- Select the  sensor control.
- Select  Minute minder.
- Set the minute minder time you require.
- Touch **Close** to confirm.

When the oven is switched off, the minute minder time counts down in the display and  appears instead of the time of day.

If you are cooking at the same time or if you are in a different menu, the minute minder time and  will appear at the top right-hand side of the display.

At the end of the minute minder time,  will flash, the time will start counting up and a buzzer will sound.

- Select the  sensor control or the desired minute minder in the display. The buzzer will stop and the symbols in the display will go out.

## Changing the minute minder duration

- Select the minute minder in the display or select the  sensor control and then the desired minute minder duration.

The minute minder duration selected will appear.

- Set a new minute minder duration.
- Touch **Close** to confirm.

The changed minute minder duration is now saved and will count down in minutes. Minute minder durations of less than 10 minutes will count down in seconds.

## Deleting the minute minder duration

















- Select the minute minder in the display or select the  sensor control and then the desired minute minder duration.

The minute minder duration selected will appear.







- Select **Delete**.
- Touch **Close** to confirm.

The minute minder duration is now deleted.

## Main and sub-menus

Menu	Recommended value	Range
Oven functions 		
Fan plus 	160 °C	30–250 °C
Conventional heat 	180 °C	30–280 °C
Moisture plus 		
Moisture plus + Auto roast 	160 °C	130–230 °C
Moisture plus + Fan plus 	160 °C	130–250 °C
Moisture plus + Intensive bake 	170 °C	130–250 °C
Moisture plus + Conventional 	180 °C	130–280 °C
Intensive bake 	170 °C	50–250 °C
Auto roast 	160 °C	100–230 °C
Bottom heat 	190 °C	100–280 °C
Top heat 	190 °C	100–250 °C
Full grill 	240 °C	200–300 °C
Economy grill 	240 °C	200–300 °C
Fan grill 	200 °C	100–260 °C
Eco Fan heat 	190 °C	100–250 °C
Automatic programmes 		





## Main and sub-menus

Menu	Recommended value	Range
Special applications 		
Defrost	25 °C	25–50 °C
Drying	90 °C	80–100 °C
Heat crockery	80 °C	50–100 °C
Prove dough		
Prove for 15 minutes	–	–
Prove for 30 minutes	–	–
Prove for 45 minutes	–	–
Low temp. cooking	100 °C	80–120 °C
Keeping warm	75 °C	60–90 °C
MyMiele  		
User programmes 		
Settings 		
Maintenance 		
Descalc		
Pyrolytic		

# Energy saving tips

---

## Cooking programmes

- If possible, use the automatic programmes for cooking food.
  - Remove all accessories from the oven compartment that are not required for cooking.
  - In general, if a range of temperatures is given in a recipe or chart, it is best to select the lower temperature and to check the food after the shortest duration.
  - Preheat the oven compartment only if instructed to do so in the recipe or the cooking chart.
  - If possible, do not open the door during a programme.
  - Use dark, matt bakeware and cooking containers made of non-reflective materials (enamelled steel, heat-resistant glass, coated aluminium). Shiny materials such as stainless steel or aluminium reflect the heat and therefore can give a more uneven food heating result. Do not cover the oven floor or the rack with heat-reflecting aluminium foil.
  - Monitor cooking durations to avoid wasting energy when cooking. Set the cooking duration, or use a food probe if you have one.
- The Fan plus  function can be used for cooking many types of food. Because the fan distributes the heat in the oven compartment straight away, it allows you to use a lower temperature than you would with Conventional heat . It also enables you to cook on multiple shelf levels at the same time.
  - Eco Fan heat  is an innovative function which is suitable for smaller foodstuffs, e.g. frozen pizzas, part-baked rolls, biscuits and for meat dishes and roasts. Energy-efficient cooking thanks to optimal utilisation of heat. When cooking on a single shelf, up to 30 % less energy is used with comparatively good cooking results. Do not open the door during the cooking programme.
  - Fan grill  is the best function for grilled dishes. With this function you can use lower temperatures than in other grill functions which use the maximum temperature setting.
  - Whenever possible you should cook multiple foods at the same time. Place them next to each other in the oven or on different shelf levels.
  - Foods which you are unable to cook at the same time should, if possible, be cooked one after the other in order to make use of existing heat in the oven.



## Residual heat utilisation

- In cooking programmes using temperatures greater than 140 °C and with cooking durations longer than 30 minutes, the temperature can be turned down to the lowest possible level about 5 minutes before the end of the cooking programme. The residual heat in the oven is sufficient for cooking the food until it is done. However, never switch the oven off (see “Warning and safety instructions”).
- If you have set a cooking duration for a cooking programme, the oven heating elements will switch off automatically shortly before the end of cooking. The residual heat in the oven is sufficient to complete the cooking process.
- It is best to start the pyrolytic cleaning programme immediately after a cooking programme. The residual heat in the oven will help reduce the amount of energy required.

## Settings

- Select the setting **Display | QuickTouch | Off** for the control elements in order to reduce energy consumption.
- Select the **Lighting | Off** or **"On" for 15 seconds** setting for the oven interior lighting. The oven interior lighting can be switched on again at any time by touching the  sensor control.

## Energy-saving mode

The oven will switch itself off automatically to save energy if a programme is not being run and controls have not been operated. The time of day will appear in the display or the display will remain dark (see “Settings”).

## Operation

---

- Switch the oven on.

The main menu will appear.

- Place the food in the oven compartment.
- Select Oven functions .
- Select the desired function.

The function and the recommended temperature will appear.

- Change the recommended temperature if necessary.

The recommended temperature will be accepted within a few seconds. You can change the temperature later by selecting the temperature indicator.

- Confirm with *OK*.

The required and the actual temperature will appear and the heating-up phase will begin.

You will see the temperature increasing. A buzzer will sound when the set temperature is reached for the first time.

- After the cooking programme, select Finish.
- Take the food out of the oven compartment.
- Switch the oven off.

### Changing values and settings for a cooking programme

Depending on the function, as soon as a cooking programme is in progress, you can change the values or settings for this programme.

Depending on the function, you can change the following settings:

- Temperature
- Duration
- Finish at
- Start at
- Booster
- Pre-heat
- Rapid cooling
- Keeping warm
- Crisp function

### Changing the temperature and core temperature

Go to Settings | Recommended temperatures to permanently adjust the recommended temperatures to suit your cooking preferences.

The  core temperature only appears if you are using the food probe (see “Roasting – Food probe”).

- Touch the temperature display.
- Change the temperature and the  core temperature if necessary.
- Confirm with *OK*.

The cooking programme will restart with the new desired temperatures.

## Setting cooking durations

Cooking results can be impaired if there is a long delay between the food being placed in the oven and the start of cooking. Fresh food can change colour and even deteriorate. When baking, the cake mixture or dough can dry out, and the raising agents can lose their effectiveness. Select as short as possible a time until the cooking programme starts.

You have placed the food in the oven compartment, selected a function and the required settings such as the temperature.

By entering **Duration**, **Finish at** or **Start at**, you can automatically switch the cooking programme off or on and off.

- **Duration**  
Enter the desired cooking duration for the food. The heating will switch off automatically once this duration has elapsed. The maximum cooking duration that can be set depends on the function that you have selected.
- **Finish at**  
Specify when you want the cooking programme to end. The oven heating will switch off automatically at the time you have set.
- **Start at**  
This function will only appear in the menu if you have set a **Duration** or **Finish at time**. With **Start at**, you have to specify when you want the cooking programme to start. The oven heating will switch on automatically at the time you have set.

- Select  or **Timer**.
- Set the desired times.
- Confirm with **OK**.

## Changing the set cooking durations

- Select , the duration or **Timer**.
- Select the desired time and change it.
- Confirm with **OK**.

These settings will be deleted in the event of a power failure.

# Operation

## Deleting the set cooking durations

- Select , the duration or Timer.
- Select the desired time.
- Select Delete.
- Confirm with *OK*.

If you delete Duration, the set times for Finish at and Start at are also deleted.

If you delete Finish at or Start at, the cooking programme will start using the cooking duration set.

## Cancelling a cooking programme

If you cancel a cooking programme, the oven heating and lighting will switch off. Any cooking durations set will be deleted.

When the Rapid cooling is switched on, the door automatically opens a little once the cooking programme is brought to an end and the cooling fan quickly cools the food and the oven compartment.

Select Close to return to the main menu.

## Cancelling a cooking programme without a set cooking duration

- Select Finish.

The main menu will appear.

## Cancelling a cooking programme with a set cooking duration

- Select Cancel.

Cancel process? appears in the display.

- Select Yes.

The main menu will appear.





## Pre-heating the oven compartment

The Booster function is used to quickly pre-heat the oven compartment in some functions.

The Pre-heat function can be used with any function and has to be switched on separately for each cooking programme.

If you have set a cooking duration, it will only start to count down when the desired temperature is reached and you have placed the food in the oven.

It is only necessary to pre-heat the oven compartment in a few instances.

- Most foods can be placed in the oven compartment while it is still cold in order to make use of the heat produced during the heating-up phase.
- Pre-heat the oven compartment when cooking the following food and using the following functions:
  - Dark bread doughs as well as beef sirloin and fillet with the Fan plus , Moisture plus  and Conventional heat  functions
  - Cakes and pastries with a short cooking duration (approx. 30 minutes or less) as well as delicate items (e.g. sponge) with the Conventional heat  function (without the Booster function)

## Booster

The **Booster** function is used to quickly pre-heat the oven compartment.

This function is switched on as the factory default setting for the following functions (Settings | **Booster** | On):

- Fan plus 
- Conventional heat 
- Auto roast 
- Moisture plus 

If you set a temperature above 100 °C and the **Booster** function is switched on, a rapid heating-up phase heats the oven compartment to the set temperature. The top heat/grill element and the ring heating element come on together with the hot air fan.

Delicate items (e.g. sponge or biscuits) will get brown too quickly on the top with the **Booster** function. Switch off the **Booster** function for these items.

## Switching the **Booster** on and off for a cooking programme

If you have selected the **Booster** | On setting, you can switch off the function separately for a cooking programme.

On the other hand, you can also switch on the function separately for a cooking programme if you have selected the **Booster** | Off setting.

Example: you have selected a function and the required settings such as the temperature.

You want to switch off the **Booster** function for this cooking programme.

- Drag down the pull-down menu.

**Booster** is highlighted in orange.

- Select **Booster**.

Depending on the colour scheme, **Booster** is highlighted either in black or white.

- Close the pull-down menu.

The **Booster** function is switched off during the heating-up phase. Only the heating elements associated with the function are pre-heating the oven compartment.

## Pre-heat

It is only necessary to pre-heat the oven compartment in a few instances.

You can place most dishes in the cold oven compartment to make use of the heat produced during the heating-up phase.

If you have set a cooking duration, it will only start to count down when the desired temperature is reached and you have placed the food in the oven.

Start the cooking programme immediately without delaying the start time.

## Switching on Pre-heat

The **Pre-heat** function can be used with any operating mode and has to be switched on separately for each cooking programme.

Example: you have selected a function and the required settings such as the temperature.

You want to switch on the **Pre-heat** function for this cooking programme.

# Operation

---

- Drag down the pull-down menu.

Depending on the colour scheme, Pre-heat is highlighted either in black or white.

- Select Pre-heat.

Pre-heat is highlighted in orange.

- Close the pull-down menu.

The following message is displayed with a time: Place food in the oven at . The oven compartment is heated to the set temperature.

- As soon as you are prompted to do so, place the food in the oven compartment.
- Confirm with *OK*.

## Rapid cooling

Using the Rapid cooling function you can quickly cool down food and the oven compartment once the cooking process is brought to an end.

### Switching Rapid cooling on or off for a cooking programme

If you have selected the Rapid cooling | On setting, you can switch off the function separately for a cooking programme.

On the other hand, you can also switch on the function separately for a cooking programme if you have selected the Rapid cooling | Off setting.

Example: You have selected a function and the required settings such as the temperature.

You want to switch off the Rapid cooling function for this cooking programme.

- Drag down the pull-down menu.

Rapid cooling is highlighted in orange.

- Select Rapid cooling.

Depending on the colour scheme, Rapid cooling is highlighted in either black or white.

If the Keeping warm function is also switched on, When rapid cooling is deactivated, keeping warm is also switched off. will appear.

- If necessary, confirm with *OK*.
- Close the pull-down menu.

The Rapid cooling and Keeping warm functions are switched off. Once the cooking process is brought to an end, the door remains closed. The cooling fan cools the food and the oven compartment.

## Keeping warm

Using the Keeping warm function you can keep food warm after cooking without inadvertently cooking it further. The food is kept warm at a pre-set temperature (see “Settings” – “Recommended temperatures”).

If you are using the food probe, the oven compartment temperature will be approx. 20 °C greater than the core temperature when this feature is in operation.

It is only possible to use the Keeping warm function in combination with the Rapid cooling function.

If you have selected the Keeping warm | On setting, you can switch off the function separately for a cooking programme.

On the other hand, you can also switch on the function separately for a cooking programme if you have selected the Keeping warm | Off setting.

### Switching on Keeping warm for a cooking programme

Example: You have selected a function and the required settings such as the temperature.

You want to switch on the Keeping warm function for this cooking programme.

- Drag down the pull-down menu.

Depending on the colour scheme, Keeping warm is highlighted in either black or white.

- Select Keeping warm.

When the Rapid cooling function is also switched off, Keeping warm requires rapid cooling. This function will be activated. will appear.

- If necessary, confirm with *OK*.

Keeping warm and Rapid cooling are highlighted in orange.

- Close the pull-down menu.

The Keeping warm and Rapid cooling functions are switched on. Once the cooking programme is brought to an end, the door opens a little automatically. The cooling fan cools the food and the oven compartment quickly to the pre-set temperature.

Once this temperature is reached, the door is closed again automatically in order to keep the food warm.

### Switching off Keeping warm for a cooking programme

Example: You have selected a function and the required settings such as the temperature.

You want to switch off the Keeping warm function for this cooking programme.

- Drag down the pull-down menu.

Keeping warm is highlighted in orange.

- Select Keeping warm.

Depending on the colour scheme, Keeping warm is highlighted in either black or white.

The setting for the Rapid cooling function does not change.

- Close the pull-down menu.

The Keeping warm function is switched off. Once the cooking process is brought to an end, the door remains closed. The cooling fan cools the food and the oven compartment.

# Operation

---

## Crisp function

It is a good idea to use the Crisp function (moisture reduction) when cooking food which has a moist topping e.g. quiche, pizza, tray bakes with fresh fruit toppings or muffins.

Poultry in particular gets a good crisp skin with this function.

### Switching on Crisp function

The Crisp function can be used with any operating mode and has to be switched on separately for each cooking programme.

You have selected a function and the required settings such as the temperature.

You want to switch on the Crisp function for this cooking programme.

- Drag down the pull-down menu.

Depending on the colour scheme, Crisp function is highlighted either in black or white.

- Select Crisp function.

Crisp function is highlighted in orange.

- Close the pull-down menu.

The Crisp function is switched on.

## Changing the function

You can change to another function during a cooking programme.

- Touch the symbol for the selected function.
- If you have set a cooking duration, confirm the **Cancel process?** message with **Yes**.
- Select the new function.





The new function appears in the display with its corresponding recommended values.

- Set the values for the cooking programme and confirm with **OK**.



Your oven is equipped with a steam injection system for cooking programmes aided by moisture. Baking, roasting and cooking using the Moisture plus  function guarantees optimum steam and air flow for even cooking and browning results.

You can also use this moisture assistance feature with various functions:

- Moisture plus + Auto roast 
- Moisture plus + Fan plus 
- Moisture plus + Intensive bake 
- Moisture plus + Conventional 

After selecting the desired function, set the temperature and the number and type of bursts of steam (Automatic, Manual or with timer).

Fresh tap water is taken into the steam system via the tube underneath the control panel on the left.

Liquids other than water can cause damage to the oven.  
Only use tap water when cooking with the addition of moisture.

The water is injected as bursts of steam into the oven compartment during the cooking programme. The steam openings are located at the back left corner at the top of the oven compartment.

## Suitable food items

One burst of steam takes about 5–8 minutes. The number of bursts of steam and when they are performed will depend on the type of food being cooked:

- **Yeast doughs** will rise better if steam is released at the beginning of the programme.
- **Bread and bread rolls** rise better if steam is released at the start. Another burst of steam at the end of the programme will give the bread and rolls a glistening crust.
- When **roasting meat with a high fat content**, releasing steam at the beginning of roasting will help render the fat.

Additional moisture is not suitable for mixtures which already contain a lot of moisture, such as meringues. These need to dry out during baking.

**Tip:** Use the supplied recipes or the Miele@mobile app for reference.

# Moisture plus

## Starting a cooking programme with Moisture plus

It is normal for condensation to form on the inside of the door during steam injection. This will evaporate during the course of the cooking programme.

- Prepare the food and place it in the oven compartment.
- Select Oven functions .
- Select Moisture plus .
- Select the desired function with moisture assistance.  
The cooking programmes proceed in the same way for all heating types.

The recommended temperature (160 °C) will appear.

### Setting the temperature

- Change the recommended temperature if necessary.
- Select Continue.
- If necessary, switch on the Pre-heat function via the pull-down menu.

The selection display for releasing the bursts of steam will then appear.

## Selecting the bursts of steam

- Select Automatic, Manual or with timer.
  - Automatic  
1 burst of steam will be injected into the oven automatically after the heating-up phase.
  - Manual  
You can release 1, 2 or 3 bursts of steam manually using the touch display.
  - with timer  
You can set the times for the bursts of steam to be released. The oven then releases 1, 2 or 3 bursts of steam at the set times.

If you are cooking food, e.g. bread or bread rolls, in a pre-heated oven compartment it is best to release the steam manually and switch on the Pre-heat function. The first burst of steam should be released as soon as you have placed the food in the oven.

If you select more than one burst of steam, the second burst of steam cannot be released before the temperature in the oven compartment has reached at least 130 °C.

If you want to use the Pre-heat function, be aware of the heating-up phase when it comes to manual and time controlled bursts of steam (see “Operation” – “Pre-heat”).

- Select the number of bursts of steam (for Manual and with timer only).
- Set the times for the bursts of steam as required.
- Select Continue.

The prompt to draw in water then appears.

## Preparing and starting the water intake process

- Fill a suitable container with the required amount of fresh tap water.
- Open the door.
- Pull the water intake pipe forwards (located below the control panel on the left).

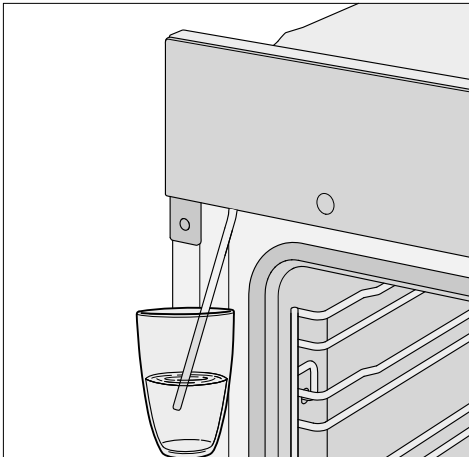

- Immerse the end of the water intake pipe in the container with the tap water.
- Confirm with *OK*.

The water intake process will begin.

The amount of water actually drawn up into the oven may be less than the amount specified as required, leaving a small amount in the container.

You can interrupt and resume the intake process at any time by selecting *Stop* or *Start*.

- Remove the water container after the water intake process and close the door.

The sound of the pump running can be heard again briefly. Residual water in the water intake pipe is being drawn into the oven.

The oven heating and cooling fan will switch on. The required and the actual temperature will appear.

You will see the temperature increasing. A buzzer will sound when the set temperature is reached for the first time.

If you have selected *with timer*, you can check the time before steam is released by selecting **i** *Info*.

# Moisture plus

---

## Releasing bursts of steam

 Danger of injury caused by steam.

Steam can cause severe scalding. In addition, steam condensing on the control panel will cause the sensor controls and the touch display to react more slowly.

Do not open the door whilst steam is being released.

### Automatic

Once the heating-up phase has been completed, the steam is released automatically.

The water will evaporate in the oven compartment and **Burst of steam** will appear in the display.

After the steam has been released, **Burst of steam** will disappear.

- Continue cooking the food until the end of the cooking duration.

### Manual

You can release the steam as soon as **Burst of steam** appears and **Start** is shown in green.

Please wait until the heating-up phase is completed to allow the steam to be distributed evenly by the warm air in the oven.

**Tip:** Refer to the supplied recipe book or the Miele@mobile app for tips on when to release the bursts of steam. Use the **Minute minder**  function to remind you.

- Select **Start**.

The steam will be released. **Start** is deactivated.

- Proceed as described to release further bursts of steam once **Start** is shown in green.

After the final burst of steam, **Start** is deactivated.

- Continue cooking the food until the end of the cooking duration.

### with timer

The oven will release the bursts of steam at the specified times.

**Burst of steam** appears when the steam is being released.

After the final burst of steam, **Burst of steam** will disappear.

- Continue cooking the food until the end of the cooking duration.

## Evaporate residual moisture

When cooking using the addition of moisture, the water will be equally distributed between the bursts of steam and used up as long as the programme is not interrupted.

However, if a programme using the addition of moisture is manually interrupted before all the bursts of steam have been released or if there is a power cut, the water for these unused bursts of steam will remain in the steam injection system.

The next time Moisture plus  or an automatic programme with moisture is used, Evaporate residual moisture will appear in the display with the options.

- It is best to start the evaporation of residual water straight away so that only fresh water is used during a food cooking programme.

 Danger of injury caused by steam.

Steam can cause severe scalding.  
Do not open the door whilst steam is being released.

Depending on the amount of water, evaporation of residual water can take up to 30 minutes.

The oven compartment is heated up and the remaining water is evaporated, causing condensation to form in the oven compartment and on the door.

- Be sure to wipe away the condensation from the door and oven compartment once the compartment has cooled down.

# Moisture plus

## Starting residual water evaporation immediately

 Danger of injury caused by steam.

Steam can cause severe scalding.  
Do not open the door whilst steam is being released.

- Select a function or an automatic programme that uses moisture.

The prompt *Evaporate residual moisture?* will then appear.

- Select *Yes*.

*Evaporate residual moisture* and a time then appear in the display.

The residual water evaporation will then start. You can follow the time counting down in the display.

The time shown in the display will depend on the amount of residual water left in the steam injection system. During the evaporation process, the duration may be adjusted by the system according to the amount of water currently present.

At the end of the residual water evaporation process, *Finished* will appear.

- Select *Close*.

A cooking programme using a function or an automatic programme with moisture assistance can now be run.

Whilst residual water is evaporating, moisture will condense on the door and in the oven compartment. This moisture needs to be removed after the oven compartment has cooled down.

## Skipping residual water evaporation

Allowing further intake of water can, under extremely adverse circumstances, cause water to overflow from the steam injection system into the oven compartment. It is therefore best not to cancel the evaporation process.

- Select a function or an automatic programme that uses moisture.

*Evaporate residual moisture?* appears.

- Select *Skip*.

A cooking programme using a function or an automatic programme with moisture assistance can now be run.

You will be prompted to carry out the evaporation of residual water the next time you select the function or an automatic programme that uses moisture assistance and when you switch the oven off.

The wide range of automatic programmes enable you to achieve excellent results with ease.

## Categories

The  automatic programmes are sorted into categories to provide a better overview. Simply select the appropriate programme for the type of food you are cooking and follow the instructions in the display.

## Using automatic programmes

- Select Automatic programmes .

A list will appear in the display.

- Select the desired food category (e.g. Cakes).

The automatic programmes available for the food category selected will then appear.

- Select the desired automatic programme.
- Follow the instructions in the display.

Some automatic programmes and special applications will prompt you to use the food probe. Read the information under “Roasting – Food probe”.

The core temperature cannot be changed for the automatic programmes.

**Tip:** Use  Info to display information such as how to place or turn the food depending on the cooking programme.

## Handy hints

- When using automatic programmes, the recipes provided are designed as a guide only. Other similar recipes, including those using different quantities, can be used for the automatic programme in question.
- After cooking, allow the oven compartment to cool down to room temperature again before starting an automatic programme.
- Some automatic programmes require a pre-heating phase before food is placed in the oven compartment. A prompt will appear in the display indicating when this needs to be done.
- Some automatic programmes require the addition of liquid after a certain cooking duration. You will be prompted by a message in the display when this needs to be done (e.g for adding liquid).
- The duration quoted for automatic programmes is an estimate. It may increase or decrease depending on the programme. The duration, in particular with meat, will vary depending on the initial temperature of the food.

# Automatic programmes

---

- When using the food probe, the cooking duration will depend on when the core temperature is reached.
- If by the end of an automatic programme the food is not cooked enough, select *Continue cooking* or *Continue baking*. Conventional heating will then be used for 3 minutes to continue cooking or baking the food.

## Search

(Depending on language)

Under *Automatic programmes*, you can search by the name of the categories and the automatic programmes.

There is a full text search function which can also be used to search for parts of words.

From the main menu:

- Select *Automatic programmes* .

The category list will appear in the display.

- Select *Search*.
- Use the keyboard to type in the search text, e.g. "Bread".

The number of hits will be shown in the footer.

If no match is found, or if there are more than 40 matches, the *hits* field is deactivated and you will need to change the search text.

- Select *XX hits*.

The categories and automatic programmes available will then appear.

- Select the desired automatic programme, or the category and then the automatic programme.

The automatic programme will start.

- Follow the instructions in the display.



This section provides information on the following applications:

- Defrost
- Drying
- Heat crockery
- Prove dough
- Low temp. cooking
- Keeping warm
- Frozen food/ready meals

### Defrost

Gentle defrosting of frozen goods ensures that most of the vitamins and minerals are retained.

- Select Special applications .
- Select Defrost.
- Alter the recommended temperature if necessary and then set the duration

Air is circulated throughout the oven compartment to gently defrost the frozen goods.

 Risk of infection from bacteria.

Bacteria such as salmonella can cause life-threatening food poisoning.

It is particularly important to observe food hygiene rules when defrosting fish and meat, and in particular when defrosting poultry.

Do not use the liquid produced during defrosting.

Process the food as required as soon as it has been defrosted.

### Tips

- Remove the packaging and place the frozen goods on the universal tray or in a suitable bowl or dish.
- Use the universal tray with the rack placed on top of it for defrosting poultry. This way the frozen goods will not be lying in the defrosted liquid.
- Meat, poultry or fish does not need to be fully defrosted before cooking. Defrost until the food has started to thaw. The surface will then be sufficiently thawed to take herbs and seasoning.

# Special applications

## Drying

Dehydrating or drying is a traditional method of preserving fruit, certain vegetables and herbs.











It is important that fruit and vegetables are ripe and not bruised before they are dried.

- Peel and core the food for drying, if necessary, and cut it up.
- Distribute the food to be dried evenly according to size over the rack or the universal tray.  
If using the rack and universal tray, place the universal tray below the rack.

**Tip:** You can also use the gourmet perforated baking tray, if you have one.

- Select Special applications .
- Select Drying.
- Alter the recommended temperature if necessary and then set the duration
- Follow the instructions on the display.
- Turn the food for drying on the universal tray at regular intervals.



The drying times are longer for whole or halved food.

Food for drying		 [°C]	 [h]
Fruit	 / 	60–70	2–8
Vegetables	 / 	55–65	4–12
Mushrooms	 / 	45–50	5–10
Herbs	 / 	30–35	4–8

Special application/function

 Special application Drying

 Function Fan plus

 Temperature,  Drying time

- Reduce the temperature if condensation begins to form in the oven compartment.

## Removing the dried food

 Risk of injury caused by hot surfaces.

The oven gets hot during operation. You could burn yourself on the heating elements, oven compartment or accessories.

Use oven gloves when removing dried food from the oven.

- Allow the dried fruit or vegetables to cool down after drying.

Dried fruit needs to be completely dry, but also soft and elastic. Juice should not escape when cut.

- Store dried food in sealed glass jars or tins.

## Heat crockery

By pre-heating the crockery, the food does not cool down as quickly.

Use heat-resistant crockery.

- Place the rack on shelf level 2 and place the crockery to be warmed on it. Depending on the size of the crockery, you can also place the rack on the oven floor and take the side runners out to make more room.
- Select Special applications .
- Select Heat crockery.
- Alter the recommended temperature if necessary and then set the time.
- Follow the instructions on the display.



**Danger of injury caused by hot surfaces.**

The oven gets hot during operation. You could burn yourself on the heating elements, oven compartment or accessories. Droplets of water may have accumulated underneath the crockery.

Use oven gloves when removing the crockery from the oven.

## Prove dough

This programme is designed specifically for proving yeast dough.

- Select Special applications .
- Select Prove dough.
- Select the proving time.
- Follow the instructions on the display.

## Keeping warm

You can keep food warm in the oven compartment for several hours.

In order to maintain the quality of food, select the shortest possible time.

- Select Special applications .
- Select Keeping warm.
- Place the food to be kept warm in the oven compartment and confirm with *OK*.
- Alter the recommended temperature if necessary and then set the time.
- Follow the instructions in the display.

# Special applications

---

## Low temp. cooking

The Low temp. cooking cooking method is ideal for cooking beef, pork, veal or lamb when a tender result is desired.

First sear the meat all over at a high temperature on the hob in order to seal it.

Then place the meat in the pre-heated oven compartment where the low temperature and long cooking duration will cook it to perfection and ensure it is very tender.

The meat will relax. The juices inside will start to circulate evenly throughout the meat to reach the outer layers. This gives very tender and succulent results.

- Use lean meat which has been correctly hung and trimmed. Bones must be removed before cooking.
- For searing, use a suitable cooking oil or fat that can withstand high temperatures (e.g. clarified butter, vegetable oil).
- Do not cover meat during cooking.

The cooking duration takes approx. 2–4 hours depending on the weight and size of the meat and how well you want it cooked.

- As soon as the cooking programme is done, you can carve the meat straight from the oven. It does not need to rest.
- The meat can be left in the oven compartment to keep warm until you serve it. This will not affect results in any way.
- Serve on pre-heated plates with very hot sauce or gravy to prevent it cooling down too quickly. The meat is at the ideal temperature for eating straight away.

**Tip:** Using the pull-down menu, switch on the Keeping warm function to keep the food warm without inadvertently cooking it further.

## Using the Low temp. cooking special application

Observe the information under “Roasting – Food probe”.

- Select Special applications .
- Select Low temp. cooking.
- Follow the instructions in the display. Place the necessary accessories in the oven compartment for the pre-heating phase.
- Set the temperature and the core temperature.
- Whilst the oven compartment is pre-heating, sear the meat thoroughly on all sides on the hob.

 Danger of burning due to hot surfaces.

The oven gets hot during operation. You could burn yourself on the heating elements, oven compartment or accessories.

Use oven gloves when placing food in the oven or removing it and when working in the hot oven compartment.



- As soon as Insert food probe and place food in the oven appears in the display, place the seared meat on the rack and insert the metal tip of the food probe fully into the centre of the meat.
- Close the door.

At the end of the programme, Finished appears in the display and a buzzer sounds.

## Using the Conventional heat function

Follow the information in the cooking charts at the end of this book.

Use the universal tray with the rack placed on top of it. Switch off the Booster function for the pre-heating phase.

- Place the rack together with the universal tray on shelf level 2.
- Select Oven functions .
- Select the Conventional heat  function and a temperature of 120 °C.
- Switch off the Booster function via the pull-down menu.
- Pre-heat the oven compartment together with the universal tray and rack for approx. 15 minutes.
- Whilst the oven compartment is pre-heating, sear the meat thoroughly on all sides on the hob.

 Danger of burning due to hot surfaces.

The oven gets hot during operation. You could burn yourself on the heating elements, oven compartment or accessories.

Wear oven gloves when placing hot food in the oven or removing it and when adjusting oven shelves, for example, in a hot oven compartment.

- Place the seared meat on the rack.
- Reduce the temperature to 100 °C (see “Cooking charts”).
- Continue cooking the meat until it is done.

# Special applications

---

## Frozen food/Ready meals

### Tips for cakes, pizza and baguettes

- Bake cakes, pizza and baguettes on baking paper on the rack.  
Do not use the baking tray or the universal tray for frozen foods with a large surface area. The tray could become warped and difficult, or even impossible, to remove from the oven compartment when hot. Additional use will make the warping worse.
- Use the lowest temperature recommended on the packaging.

### Tips for French fries, croquettes and similar items

- These frozen items can be cooked on the baking tray or universal tray.  
Place baking parchment on the tray so that they cook gently.
- Use the lowest temperature recommended on the packaging.
- Turn food several times during cooking.

## Preparing frozen food/ready meals

Handling food carefully will help protect your health.

Cakes, pizzas and french fries should be cooked until golden, not dark brown.

- Select the function and temperature recommended on the packaging.
- Pre-heat the oven compartment.
- Place the food in the pre-heated oven compartment on the shelf level recommended on the packaging.
- Check the food at the end of the shortest cooking duration recommended on the packaging.

Under MyMiele , you can save frequently used applications.

It is particularly useful with automatic programmes as you do not need to work through every screen in order to start your programme.



**Tip:** You can also set menu options that you have entered in MyMiele as your status display (see “Settings – Status display”).

## Adding entries

You can add up to 20 entries.

- Select MyMiele .
- Select Add entry.

You can select sub-menus from the following:

- Oven functions 
- Automatic programmes 
- Special applications 
- User programmes 
- Maintenance 

- Confirm with OK.

The selected sub-option with its symbol appears in the list.

- Proceed as described for further entries. Only sub-options which have not yet been added are available for selection.

## Deleting entries

- Select MyMiele .
- Touch the entry you want to delete and keep your finger on it until the context menu appears.
- Select Delete.

The entry will then be removed from the list.

## Moving entries

- Select MyMiele .
- Touch the entry you want to move and keep your finger on it until the context menu appears.
- Select Move.

An orange border appears around the entry.

- Move the entry.

The entry appears in the desired position.

# User programmes

---

You can create and save up to 20 User programmes.

- You can combine up to 10 cooking stages to accurately programme your favourite or most frequently used recipes. In each cooking stage, you can select settings such as the function, temperature and cooking duration or core temperature.
- You can specify the shelf level(s) for the food.
- You can enter the name of the programme for your recipe.

When you call up and start your programme again, it will run automatically.

There are different ways of creating a User programme:

- At the end of an automatic programme, save it as a User programme.
- Save a cooking programme after running it with a set cooking duration. Then enter a programme name.

## Creating User programmes

- Select **User programmes** .
- Select **Create programme**.

You can now specify the settings for the first cooking stage.

Follow the instructions in the display:

- Select and confirm the desired settings.

If you select the **Pre-heat** function, use **Add** to add another cooking stage where you set a cooking duration. Only then can you save or start the programme.

The settings for the first cooking stage have now been set.

You can add more cooking stages, for example, if you want to add another cooking function to follow on from the first.

- If additional cooking stages are required, select **Add** and proceed as for the first cooking stage.
- When you have finished setting all the cooking stages, select **Set shelf level**.
- Select the desired level(s).
- Confirm with **OK**.

If you want to check the settings or to change them at a later date, touch the cooking stage in question.

- Select **Save**.
- Enter the programme name using the keyboard.

You can add a line break for longer programme names using the  symbol.

- Once you have entered the programme name, select **Save**.

A message will appear in the display confirming that the programme name has been saved.

- Confirm with **OK**.

You can start the saved programme immediately, delay the start or change the cooking stages.



## Starting User programmes

- Place the food in the oven compartment.
- Select User programmes .
- Select the desired programme.

Depending on the programme settings, the following menu options appear in the display:

- Start now  
The programme will start immediately. The oven heating will switch on immediately.
- Finish at  
Specify the time when you want the programme to stop. The oven heating will switch off automatically at the time you have set.
- Start at  
Specify the time when you want the programme to start. The oven heating will switch on automatically at the time you have set.
- Display cooking stages  
A summary of your settings will appear in the display.
- Display actions  
The required actions, e.g. placing the food in the oven, will appear in the display.
- Select the desired menu option.
- Confirm the message regarding which shelf level to place the food with *OK*.

The programme selected will begin straight away or at the time set.

Use  Info to display information such as how to place or turn the food depending on the cooking programme.

During the cooking programme, you can use the pull-down menu to switch the Rapid cooling and Keeping warm functions on or off.

- At the end of the programme, select *Close*.

## Changing cooking stages

Cooking stages in automatic programmes that have been saved under a different name cannot be changed.

- Select User programmes .
- Touch the programme you want to change and keep your finger on it until the context menu appears.
- Select *Change*.
- Select the cooking stage that you want to change or *Add* to add another cooking stage.
- Select and confirm the desired settings.
- If you want to start the modified programme without changing it, select *Start*.
- Select *Save* when you have changed all the settings.

A message will appear in the display confirming that the programme name has been saved.

- Confirm with *OK*.

The saved programme has been changed and you can start it immediately or delay the start.

# User programmes

---

## Renaming User programmes

- Select User programmes .
- Touch the programme you want to change and keep your finger on it until the context menu appears.
- Select Rename.
- Change the programme name using the keyboard.

You can add a line break for longer programme names using the  symbol.

- Once you have changed the programme name, select *Save*.

A message will appear in the display confirming that the programme name has been saved.

- Confirm with *OK*.

The programme has now been renamed.

## Deleting User programmes

- Select User programmes .
- Touch the programme you want to delete and keep your finger on it until the context menu appears.
- Select Delete.
- Confirm the query with *Yes*.

The programme will be deleted.

Go to Settings | Factory default | User programmes to delete all User programmes at the same time.

## Moving User programmes

- Select User programmes .
- Touch the programme you want to move and keep your finger on it until the context menu appears.
- Select Move.

An orange border appears around the entry.

- Move the programme.

The programme appears in the desired position.

Handling food carefully will help protect your health.

Cakes, pizzas and french fries should be cooked until golden, not dark brown.

## Tips on baking

- Set a cooking duration. If used for baking, do not delay the start for too long. Cake mixture or dough will dry out, and the raising agents will lose their effectiveness.
- Generally speaking, you can use racks, baking trays, universal trays and any type of baking tray made of heat-resistant material.
- Avoid using bright, thin-walled tins as they give an uneven or poor browning result. Under adverse circumstances, the food will not cook properly.
- Position rectangular tins with the longer side across the width of the oven compartment for optimum heat distribution and even baking results.
- Always place bakeware on the rack.
- Bake cakes with fruit toppings or deep cakes on the universal tray.

## Using baking parchment

Miele accessories, e.g. the universal tray, are treated with PerfectClean enamel (see “Features”). Surfaces treated with PerfectClean enamel generally do not need to be greased or covered with baking parchment.

- Use baking parchment when baking lye mixtures because the sodium hydroxide used can damage the surface treated with PerfectClean.
- Use baking parchment when baking sponge, meringue, macaroons or similar items. Due to their high egg white content, these are more likely to stick.
- Use baking paper when cooking frozen food on the rack.

## Notes on the cooking charts

You can find the cooking charts at the end of this book.

### Selecting the temperature

- As a general rule, select the lower temperature given in the chart. Baking at temperatures higher than those recommended may reduce the cooking duration, but will lead to uneven browning of the food, and unsatisfactory cooking results.

### Selecting the cooking duration

Unless otherwise stated, the cooking durations given in the cooking charts are for an oven compartment which has not been pre-heated. With a pre-heated oven compartment, shorten times by around 10 minutes.

- As a general rule, check the food after the shortest duration. Stick a wooden skewer into the food.

If it comes out clean without any batter/dough on it, the food is done.

# Baking

---

## Notes on the functions

You can find an overview of all the functions with their recommended values in “Main and sub-menus”.

### Using Automatic programmes

- Follow the instructions in the display.

### Using Fan plus

Because the fan distributes the heat around the oven compartment straight away, it allows you to use a lower temperature than you would with the Conventional heat  function.

Use this function if you are baking on multiple shelves at the same time.

- 1 shelf: place the food in shelf level 2.
- 2 shelves: place the food on shelf levels 1+3 or 2+4.
- 3 shelves: place the food on shelf levels 1+3+5.

## Tips

- If you are cooking on multiple shelves at the same time, slide the universal tray in on the lowest level.
- For moist biscuits and cakes, bake on a maximum of 2 shelf levels at once.

### Using Moisture plus

Use this function with your preferred type of heating for cooking with moisture assistance.

- Place the food in shelf level 2.

### Using Intensive bake

Use this function for baking cakes with moist toppings.

Do **not** use this function for baking thin biscuits.

- Place cakes on shelf level 1 or 2.

### Using Conventional heat

Dark metal, enamel, or aluminium bakeware with a matt finish, as well as heat-resistant glass, ceramic, and coated bakeware can be used.

Use this function for baking traditional recipes. If using an older recipe or cookbook, set the oven temperature 10 °C lower than the recommended one. This will not change the cooking duration.

- Place the food in shelf level 1 or 2.

### Using Eco Fan heat

Use this function for cooking small amounts of food, e.g. frozen pizzas, part-baked rolls or biscuits, while saving energy.

- Place the food in shelf level 2.

## Tips for roasting

- You can use all crockery made from temperature-resistant materials, e.g. roasting dishes, roasting pans with lid, ovenproof glass dishes, roasting bags, dishes made from earthenware or cast iron, the universal tray, rack and/or anti-splash insert (if available) on top of the universal tray.
- **Pre-heating** the oven compartment is only required when roasting beef sirloin joints and fillet. Pre-heating is generally not necessary.
- Use a **closed roasting dish** for roasting meat, such as an oven dish. The meat stays succulent. The oven compartment will also stay cleaner than when roasting on the rack. This ensures that sufficient stock remains for making gravy.
- If you are using a **roasting bag**, follow the instructions on the packaging.
- If you are using the **rack** or an **open roasting dish** for roasting, you can add a little fat or oil to very lean meat or place a few strips of streaky bacon on the top.
- **Season** the meat and place in the roasting dish. Dot with butter or margarine or brush with oil or cooking fat if necessary. For large lean cuts of meat (2–3 kg) and fatty poultry add about 1/8 litre of water to the dish.
- Do not add too much liquid during cooking as this will hinder the **browning** process. Browning only occurs towards the end of the cooking duration. Remove the lid about halfway through the cooking duration if a more intensive browning result is desired.





- At the end of the programme, take the food out of the oven compartment, cover it and leave to **stand** for about 10 minutes. This helps retain juices when the meat is carved.
- For a crisp finish, baste **poultry** 10 minutes before the end of the cooking duration with slightly salted water.

## Notes on the cooking charts

You can find the cooking charts at the end of this book.

- Take note of the temperature range, the shelf levels and the timings. These also take the type of cooking container, the size of the meat and cooking practices into account.

## Selecting the temperature

- As a general rule, select the lower temperature given in the chart. If higher temperatures are used than those specified, the meat will brown on the outside, but will not be properly cooked through.
- When cooking with Fan plus , Moisture plus  and Auto roast , select a temperature which is approx. 20 °C lower than with Conventional heat .
- For cuts which weigh more than 3 kg, select a temperature approx. 10 °C lower than that given in the roasting chart. The roasting process will take longer, but the meat will cook evenly through and the skin or crackling will not be too thick.

# Roasting

- When roasting on the rack, set a temperature approx. 10 °C lower than for roasting in a covered oven dish.

## Selecting the cooking duration

Unless otherwise stated, the durations given in the roasting chart are for an oven compartment which has not been pre-heated.

- The traditional British method for calculating the roasting time is to allow 15 to 20 minutes per lb/450 grammes, according to type of meat, plus approx. 20 minutes, adjusting the length of time as roasting proceeds to obtain the required result. The roasting time can also be determined by multiplying the thickness of the roast [cm] with the time per cm [min/cm] stated below, depending on the type of meat:

- Beef/venison: 15–18 min/cm
- Pork/veal/lamb: 12–15 min/cm
- Sirloin/fillet: 8–10 min/cm

- As a general rule, check the food after the shortest duration.

## Tips

- For frozen meat, increase the cooking duration by approx. 20 minutes per kg.
- Frozen meat weighing less than approx. 1.5 kg does not need to be defrosted before roasting.

## Notes on the functions

You can find an overview of all the functions with their recommended values in “Main and sub-menus”.

Use the **Bottom heat**  function towards the end of the cooking duration to brown the base of the food.



Do not use the **Intensive bake**  function for roasting as the juices will become too dark.

## Using Automatic programmes

- Follow the instructions in the display.

## Using **Fan plus** or **Auto roast**

These functions are suitable for roasting meat, fish and poultry that needs to be well browned as well as sirloin joints and fillet.

The **Fan plus**  function allows you to use a lower temperature than you would with the **Conventional heat**  function, because the heat is immediately distributed around the oven compartment.

In the **Auto roast**  function, the oven compartment heats initially to a high searing temperature (approx. 230 °C). As soon as this temperature has been reached, the oven automatically drops the temperature back down to the pre-selected roasting temperature (continued roasting).

- Place the food in shelf level 2.

## Using Moisture plus

Use this function with your preferred type of heating for cooking with moisture assistance.

- Place the food in shelf level 2.

## Using Conventional heat

Use this function for baking traditional recipes. If using an older recipe or cookbook, set the oven temperature 10 °C lower than the recommended one. This will not change the cooking duration.

- Place the food in shelf level 2.

## Using Eco Fan heat

Use this function for cooking smaller roasts or meat dishes while saving energy.

- Place the food in shelf level 2.

## Food probe

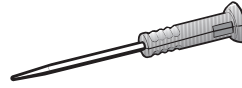

The food probe allows the temperature to be monitored precisely during a cooking programme.

### How it works

The metal tip of the food probe must be fully inserted into the centre of the food. It contains a temperature sensor. This measures the core temperature inside the food during the cooking process.

The temperature sensor is located approx. 2 cm behind the tip of the probe. Push the metal tip into the food so that the temperature sensor is in the middle (see “Important notes about using the food probe”).

The rise in the core temperature of the food reflects the progress of cooking. Set a lower or higher core temperature, depending on whether you want your roast to be medium or well-done.

The core temperature can be set up to 99 °C. Information on food and respective core temperatures can be found in the cooking charts at the end of this book.

Cooking processes with or without the food probe take the same amount of time.

## Roasting

---

Transmission of the core temperature to the oven electronics occurs via radio signal between the transmitter in the handle of the probe and the receiver antenna in the back panel, as soon as you place the food in the oven with the food probe inserted.









Efficient radio transmission is only guaranteed if the oven door is closed. If the door is opened during a cooking process, e.g. to baste the food, radio signal transmission is interrupted. It will only resume when the door is closed. It will take a few seconds before the current core temperature appears again in the display.

The temperature sensor will be damaged at temperatures over 100 °C. However there is no danger of damage occurring if it is inserted into food as the maximum core temperature that can be set is 99 °C. If you are not using the food probe, do not leave it in the oven during cooking. Always put it back into the storage sleeve in the door.

### When to use the food probe

Some automatic programmes and special applications will prompt you to use the food probe.

You can also use the food probe with User programmes and with the following functions:

- Auto roast 
- Fan plus 
- Intensive bake 
- Conventional heat 
- Moisture plus + Auto roast 
- Moisture plus + Fan plus 
- Moisture plus + Intensive bake 
- Moisture plus + Conventional 



## Important usage notes

To ensure the probe works correctly, please observe the following instructions.

The metal tip of the food probe can break.

Do not use the food probe to lift or carry the food.

- Do not use tall, narrow metal cooking containers as these can weaken the signal.
- For wireless food probes, avoid placing metal objects above them, such as a lid, aluminium foil or the rack or the universal tray on the shelf levels above. Glass lids can be used.
- Do not use another proprietary metal food probe at the same time.
- Ensure that the handle of the food probe is not sitting in the cooking liquid, on the food or on the edge of the cooking container.
- You can place the meat in a pot or on the rack.
- The metal tip of the food probe must be fully inserted into the centre of the food so that the temperature sensor reaches more or less to the core. The handle should point diagonally upwards and not horizontally towards the corners of the oven or the door.
- When cooking poultry, insert the metal tip into the thickest part of the breast. Press the breast with your index finger and thumb to find the thickest part.
- The metal tip must not touch any bone or be inserted in areas with a lot of fat. Heavily marbled areas and bones can cause cooking to end prematurely.
- If the meat is very heavily marbled with fat, select the highest core temperature given in the cooking charts.
- When using aluminium foil or roasting bags, insert the food probe through the foil/bag into the centre of the food. You can also place meat inside the bag or foil with the food probe already inserted. Follow the roasting bag manufacturer's instructions.
- The food probe can only be inserted almost horizontally in very flat pieces of food such as fish. Therefore cook flat food in glass or ceramic cooking containers as the walls of a metal cooking container would disrupt the radio signals.

A message will appear in the display if the food probe is no longer recognised during a cooking process. Change the position of the food probe in the food.

# Roasting

---

## Using the food probe

- Remove the food probe from its holder in the door.
- Select the function or automatic programme.
- Set the temperature and the core temperature if necessary.

The core temperature cannot be changed for the automatic programmes.

Follow the instructions on the display.

- Insert the metal tip of the food probe completely into the centre of the food.

The handle should be pointing diagonally upwards.

- Place the food in the oven compartment.
- Close the door.

The cooking programme is brought to an end as soon as the core temperature is reached.

## Delaying the start of a cooking programme with food probe

You can set the cooking programme to start at a later time.

- Select Start at.

The finish time can be calculated approximately because the duration of a cooking programme is about the same, whether or not the food probe is used.

You cannot set Duration and Finish at because the total cooking duration is determined by when the set core temperature is reached.

## Time left display

If the temperature set for a cooking programme is above 140 °C, the estimated time left will appear in the display. The time left is also displayed when using the “low temperature cooking” special application, where cooking takes place at lower temperatures.

The time left is calculated from the cooking temperature selected, the set core temperature, and the progress of the core temperature as it rises.

The time left first shown is an estimate. As the cooking process continues, the time left is revised continuously, and a more accurate figure is shown.

The time left will be deleted if the cooking or core temperature is changed or if a different function is selected. If the door is opened for a longer time, the time left will be recalculated.

 Risk of injury caused by hot surfaces.

If you grill with the door open, hot air will escape from the oven instead of being cooled by the cooling fan. The control elements will get hot. Grill with the oven door closed.

## Tips for grilling

- Pre-heating is necessary when grilling. Pre-heat the top heat/grill element for approx. 5 minutes with the door closed.
- Trim the meat if necessary. Do not season the meat with salt before grilling as this draws the juices out.
- Add a little oil to lean meat if necessary. Do not use other types of fat as they can easily burn and cause smoke.
- Clean fish in the normal way. To enhance the flavour, season with a little salt. Fish can also be drizzled with lemon juice.

- Use the universal tray with the rack or the grilling and roasting (anti-splash) insert in place. The juices collect under the insert. This prevents them from spitting and making the oven dirty and they can then be used for making gravy and sauces.

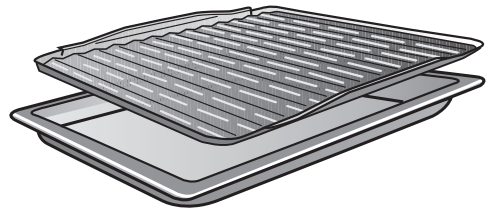
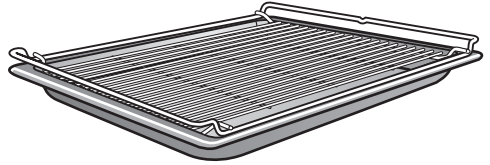

Do not use the baking tray.

- To grill, brush the rack with oil and then place the food on the rack.

## Notes on the cooking charts

You can find the cooking charts at the end of this book.

- Take note of the temperature range, the shelf levels and the durations. These take the size of the meat and cooking practices into account.
- Check the food after the shortest duration quoted.

## Selecting the temperature

- As a general rule, select the lower temperature given in the chart. If higher temperatures are used than

# Grilling

those specified, the meat will brown on the outside, but will not be properly cooked through.

## Choosing a shelf level

- Select the shelf level depending on the thickness of the food to be cooked.
- Place flat food in shelf level 3 or 4.
- Place thicker food in shelf level 1 or 2.

## Selecting the cooking duration

- Grill thinner cuts of meat/slices of fish for approx. 6–8 minutes per side. It is best to grill food of a similar thickness at the same time so that the cooking durations do not vary too much.
- As a general rule, check whether the food is cooked after the shortest duration.
- To **test the food**, press down on the meat with a spoon. This lets you determine how well the meat has been cooked.
  - **Rare/pink**  
If the meat gives easily to the pressure of the spoon, it will still be red on the inside.
  - **Medium**  
If there is some resistance, the inside will be pink.
  - **Well done**  
If there is very little resistance, it is cooked through.

**Tip:** If the surface of a thicker cut of meat is browned but the centre is still raw, move the food to a lower level or reduce the temperature and continue grilling. This will stop the surface from becoming excessively charred.

## Notes on the functions

You can find an overview of all the functions with their recommended values in “Main and sub-menus”.

The plastic on the food probe can melt at very high temperatures. Do not use the food probe when using the grill functions. Do not store the food probe in the oven compartment when it is not being used.

## Using Full grill

Use this function to grill flat thin cuts in large quantities and for browning large baked dishes.

The whole of the top heating/grill element glows red to provide the required heat.

## Using Economy grill

Use this function to grill flat thin cuts in smaller quantities and for browning small baked dishes.

Only the centre of the top heat/grill element glows red to generate the required heat.

## Using Fan grill

This function is suitable for grilling thicker food, such as chicken.

A temperature setting of 220 °C is generally recommended for thinner types of food, while 180–200 °C is recommended for thicker cuts.

 Danger of injury caused by hot surfaces.

The oven gets hot during operation. You could burn yourself on the heating elements, oven compartment or accessories.

Allow the heating elements, oven compartment and the accessories to cool before manual cleaning.

 Risk of injury due to electric shock.

The steam from a steam cleaning appliance could reach live electrical components and cause a short circuit.

Never use a steam cleaner for cleaning.

Surfaces can discolour or alter if unsuitable cleaning agents are used. The oven front is particularly susceptible to damage from oven cleaners or descaling agents. All surfaces are susceptible to scratching. Scratches on glass can in some circumstances lead to breakage.

Remove all cleaning agent residues immediately.

## Unsuitable cleaning agents

To avoid damaging the surfaces, do not use:

- cleaning agents containing soda, ammonia, acids or chlorides
- cleaning agents containing descaling agents on the front
- abrasive cleaning agents (e.g. powder cleaners, scouring milk, scouring pads)
- solvent-based cleaning agents
- stainless-steel cleaning agents
- dishwasher cleaner
- glass cleaning agents
- cleaning agents for ceramic glass hobs
- hard, abrasive brushes or sponges (e.g. pot scourers, brushes or sponges which have been previously used with abrasive cleaning agents)
- melamine eraser blocks
- sharp metal scrapers
- wire wool
- spot cleaning with mechanical cleaning agents
- oven cleaners
- stainless-steel spiral pads

If soiling is left on for any length of time, it may become impossible to remove. If items are used frequently without being cleaned, it may become very difficult to clean them. It is therefore best to remove any soiling immediately.

# Cleaning and care

---

The accessories are not suitable for cleaning in a dishwasher (except the wireless food probe).

**Tip:** Soiling caused by spilt fruit juices and cake mixtures is best removed while the oven compartment is still warm.

To make it easier to clean the oven:

- Remove the door.
- Take out the side runners with FlexiClip runners (if fitted).
- Lower the top heat/grill element.

## Removing normal soiling

There is a delicate fibreglass seal around the oven compartment to seal the glass in the oven door. This can be damaged by rubbing or scouring.

Avoid cleaning the fibreglass seal.

- Remove normal residues immediately with warm water, washing-up liquid and a clean sponge or a clean, damp microfibre cloth.
- Remove all cleaning agent residues thoroughly with clean water. This is particularly important for any parts with a PerfectClean finish, as cleaning agent residues will impair the non-stick function.
- After cleaning, wipe the surfaces dry using a soft cloth.

## Cleaning the food probe

- Clean the food probe by hand or in the dishwasher.

## Removing stubborn soiling (excluding the FlexiClip runners)

Spilt fruit and roasting juices may cause lasting discolouration or matt patches on surfaces. This discolouration will not affect the properties of the surface finish. Do not attempt to remove these stains. Only use the equipment specified.

- Baked-on deposits can be removed with a glass scraper or with a stainless-steel spiral pad (e.g. Spontex Spirinett), hot water and washing-up liquid.

To clean the glass covering for the camera, do not use stainless-steel spiral pads; only the abrasive side of a dishwashing sponge is suitable for this purpose.

## Using oven cleaners

- Very stubborn soiling on PerfectClean surfaces can be cleaned using the Miele oven cleaner, which must only be applied to cold surfaces.

If the oven spray gets into gaps and openings, a strong odour is generated during subsequent cooking programmes.

Do not spray the oven cleaner onto the roof of the oven compartment.

Do not spray the oven cleaner into the gaps and openings of the oven compartment walls and rear wall.

- Follow the instructions on the packaging.

Oven cleaners from other manufacturers must only be used in a cold oven and for no longer than a maximum of 10 minutes.

- You can then also use the scouring pad on the back of a washing-up sponge to remove the soiling.
- Remove all cleaning agent residues thoroughly with clean water.
- Dry all surfaces with a soft cloth.

# Cleaning and care

## Pyrolytic cleaning of the oven compartment

Instead of cleaning the oven compartment manually you can run the Pyrolytic  function.

During pyrolytic cleaning the oven compartment reaches temperatures in excess of 400 °C. Any residual soiling is burnt off and turned to ash by the high temperatures.

There are 3 pyrolytic settings available, each with a different duration:

- Level 1 for light soiling
- Level 2 for heavier soiling
- Level 3 for very heavy soiling

The oven door is automatically locked when the pyrolytic cleaning process is started. It cannot be opened until after the programme has finished.

The timer can be used to delay the start time of the pyrolytic cleaning programme, for instance to make use of cheaper electricity tariffs.

At the end of the pyrolytic cleaning programme any residues such as ash from the pyrolytic process, which are formed depending on the oven compartment's degree of soiling can be easily wiped away.

## Preparing for pyrolytic cleaning

Accessories that are not suitable for pyrolytic cleaning will be damaged by the high temperatures.

Remove all accessories that are not suitable for pyrolytic cleaning from the oven compartment before starting the pyrolytic cleaning programme. This also applies for optional accessories that are not suitable for pyrolytic cleaning.

The accessories below are suitable for pyrolytic cleaning and can be left in the oven compartment during pyrolytic cleaning:

- Side runners
  - FlexiClip runners HFC 72
  - Rack HBBR 72
- Remove all accessories that are not suitable for pyrolytic cleaning from the oven.
  - Place the rack on the top shelf level.

Coarse soiling in the oven compartment can cause thick smoke to develop.

Burnt-on residues can cause lasting discolouration or dull spots on enamelled surfaces.

Before starting the pyrolytic cleaning programme, remove coarse soiling from the oven compartment and scrape any burnt-on residues off enamelled surfaces with a glass scraper.



## Starting pyrolytic cleaning

 Danger of injury caused by hot surfaces.

The oven gets much hotter during pyrolytic cleaning than during normal use.

Do not let children touch the oven during pyrolytic cleaning.

- Select Maintenance .
- Select Pyrolytic.
- Select the level required according to the amount of soiling.
- Confirm with *OK*.

Follow the instructions on the display.

- Confirm with *OK*.

You can start pyrolytic cleaning straight away or schedule it to begin at a later time.

### Starting pyrolytic cleaning straight away



- To start the pyrolytic cleaning programme straight away, select *Start now*.
- Confirm with *OK*.

The pyrolytic cleaning programme will start.

The door will lock automatically. The oven heating and the cooling fan will then switch on automatically.

The oven interior lighting will not come on during the pyrolytic cleaning programme.

The time left for the pyrolytic cleaning programme will start counting down in the display. You cannot alter the duration.

You can use the minute minder at the same time as running the cleaning programme. At the end of the minute minder time the buzzer will sound,  will start flashing and the time can be viewed counting up in the display. When you touch the  sensor control, acoustic and optical signals are switched off.

### Starting pyrolytic cleaning at a later time

- To start the pyrolytic cleaning programme later, select *Start at*.
- Confirm with *OK*.
- Set the time at which pyrolytic cleaning should start.
- Confirm with *OK*.

The door will lock automatically. *Start at* and the start time set will appear in the display.

You can reset the start time via *Timer at* any point up to the starting time.

As soon as the start time has been reached, the oven heating and cooling fan will switch on automatically and the time remaining will appear in the display.

# Cleaning and care

## Finalising pyrolytic cleaning

When the time remaining has fully elapsed, a message will appear in the display to tell you that the door is unlocking.

Finished will appear in the display and a buzzer will sound as soon as the door has been unlocked.

- Confirm the message shown with *OK*.
- Select *Close*.
- Switch the oven off.

The visual and acoustic signals will switch off.

 Danger of injury caused by hot surfaces.

At the end of the pyrolytic cleaning programme, the oven will still be very hot. You could burn yourself on the heating elements, oven compartment or accessories.

Allow the heating elements, oven compartment and accessories to cool down before removing any residues or oiling the side runners.

- Clean the oven compartment and accessories suitable for pyrolytic cleaning to remove any pyrolytic residues (e.g. ash) that can build up depending on the degree of soiling in the oven compartment.
- Remove any residues from the cover of the camera. You can use the scouring pad on the back of a washing-up sponge.

- Add a few drops of heat-resistant cooking oil to some kitchen paper and use this to lubricate the side runners.

Most residues can be removed with hot water, a little washing-up liquid and a clean sponge or a clean, damp microfibre cloth.

Depending on the degree of soiling, a visible deposit could build up on the glass on the inside of the oven door. This can be removed with a dishwashing sponge, a glass scraper or a stainless-steel spiral pad (e.g. Spontex Spirinett) and a little washing-up liquid.

There is a delicate fibreglass seal around the oven compartment to seal the glass in the oven door. This can be damaged by rubbing or scouring.

Avoid cleaning the fibreglass seal.

Enamelled surfaces can be permanently discoloured by spilt fruit juices. Such discolouration does not affect the properties of the enamel. Do not attempt to remove these stains.

## Extending and retracting the FlexiClip runners

After cleaning, discolouration or light patches can remain on the FlexiClip runners. However this does not affect their operation.

- Extend and retract the FlexiClip runners several times after running the pyrolytic cleaning programme.

## Descale

The frequency of descaling will depend on the water hardness level in your area.

The descaling process can be run at any time.

However, to ensure that the oven functions correctly, you will be automatically prompted to run the descaling process for the steam injection system after a certain number of programmes.

The oven will count down in the display the last 10 programmes that can be run before it needs to be descaled. You will then not be able to run any function or automatic programme using moisture assistance.

These functions can only be used again after you have carried out a descaling process. All other functions and automatic programmes without moisture assistance can still be used.

## Descaling process sequence

Once the descaling process has been started it must be completed through to the end. It cannot be cancelled.

Descaling takes approx. 90 minutes and consists of several steps:

1. Preparing the descaling process
2. Drawing in the descaling solution
3. Activation phase
4. Rinse 1
5. Rinse 2
6. Rinse 3
7. Residual water evaporation

# Cleaning and care

## Preparing the descaling process

You will need a container of approx. 1 litre capacity.

A plastic tube (with suction cup) is supplied with your oven so that you do not have to hold the container with the descaling agent underneath the water intake pipe.

We recommend using the descaling tablets supplied. They have been specially developed for Miele for optimum results.

**Tip:** Miele descaling tablets are available to order from the Miele webshop, from the Miele Customer Service Department or from your Miele dealer.

Other descaling agents, which contain other acids besides citric acid and/or other undesirable substances, such as chlorides for example, could cause damage.

Moreover, the descaling result required could not be guaranteed if the descaling solution was not of the appropriate concentration.

- Fill the container with approx. 600 ml of cold tap water and thoroughly dissolve one descaling tablet in it.

## Carrying out the descaling process

- Select Maintenance .
- Select Descale.

If the functions and automatic programmes that use moisture assistance are already disabled, the descaling process can be started immediately by touching *OK*.

- Push the universal tray into the top shelf level as far as it will go to collect the descaling solution after it has been used. Confirm the message shown with *OK*.

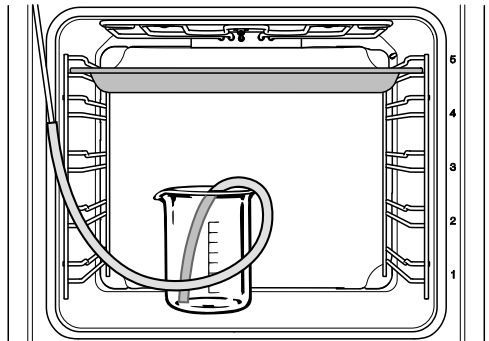

- Place the container with the descaling solution on the floor of the oven.
- Attach one end of the plastic tube to the water intake pipe. Place the other end of the plastic tube in the bottom of the descaling solution container and secure the plastic tube to the container with the suction cup.
- Confirm with *OK*.

The water intake process will begin. You will hear the noise of the pump.

You can interrupt and resume the intake process at any time by selecting **Stop** or **Start**.

The amount of solution specified can be more than the amount which is actually taken in. Some of the solution may therefore be left in the container at the end of descaling.

A message will appear to confirm that the intake process is completed.

- Confirm with **OK**.

The **activation phase** will begin. You can follow the time counting down in the display.

- Leave the container with the tube connected to the water intake pipe in the oven compartment. Top the container up with approx. 300 ml of water, as the system will need to draw in some more liquid during the activation phase.

The system will take in more liquid at approximately 5 minute intervals. You will hear the noise of the pump.

The oven interior lighting and cooling fan remain switched on for the whole duration of the process.

At the end of the activation phase a buzzer will sound.

## Rinsing the steam injection system after the activation phase

After the activation phase the steam injection system must be rinsed out to remove residues of descaling solution.

To do this approx. 1 litre of fresh tap water is pumped through the steam injection system three times and is collected in the universal tray.

- Take the universal tray with the collected descaling agent out of the oven and empty it. Place the tray back in the oven again on the top shelf level.
- Remove the plastic tube from the container.
- Remove the container, rinse it out thoroughly and fill it with approx. 1 litre of fresh tap water.
- Replace the container in the oven compartment and secure the plastic tube in the container.
- Confirm with **OK**.

The intake process for the **first rinse** will start.

The water is fed through the steam injection system and is collected in the universal tray.

Instructions for preparing the **second rinse** will appear.

- Take the universal tray with the collected rinse water out of the oven and empty it. Place the tray back in the oven again on the top shelf level.
- Remove the plastic tube from the container and fill it with approx. 1 litre of fresh tap water.
- Replace the container in the oven compartment and secure the plastic tube in the container.
- Confirm with **OK**.

# Cleaning and care

---

- Proceed in exactly the same way for the **third rinse**.

Leave the universal tray with the collected rinse water from the third rinse in the oven compartment during residual moisture evaporation.

## Evaporating residual moisture

After the third rinse residual moisture evaporation will commence.

- Remove the container and tube from the oven compartment.
- Close the door.
- Confirm with *OK*.

 **Danger of injury caused by steam.**  
Steam can cause severe scalding.  
Do not open the door while the residual water is being evaporated.

The oven heating will switch on and the duration of residual moisture evaporation will appear.

The duration is amended automatically depending on the actual amount of residual moisture.

## Finalising the descaling process

At the end of residual moisture evaporation an information window appears with tips on cleaning after the descaling process.

- Confirm with *OK*.
- A buzzer sounds and *Finished* appears.
- Select *Close*.
- Switch the oven off with the  *On/Off* button.

 **Danger of injury caused by hot surfaces.**  
The oven gets hot during operation. You could burn yourself on the heating elements, oven compartment or accessories.  
Allow the heating elements, oven compartment and the accessories to cool before manual cleaning.

- Remove the universal tray with the collected fluid and empty it.
- When the oven compartment has cooled down, clean away any condensation and descaling agent residues.
- Leave the oven door open until the oven compartment is completely dry.

## Door removal

The door weighs approx. 10 kg.

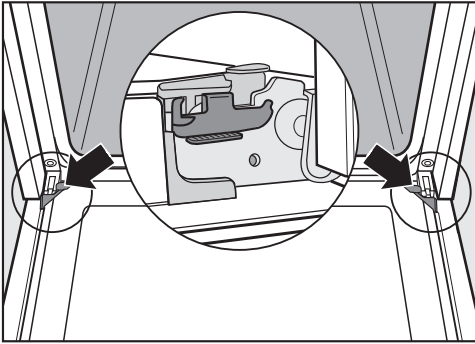

The oven door is connected to the door hinges by retainers.

Before removing the door from the retainers, the locking clamps on both door hinges have to be released.

- Open the door fully.

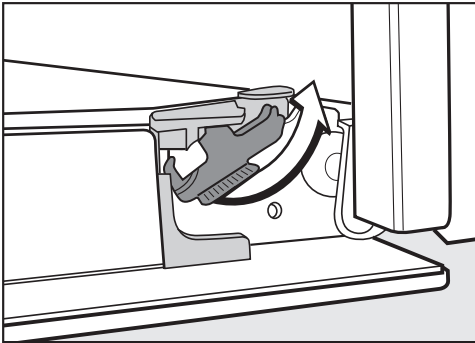

- Release the locking clamps by turning them as far as they will go.

The oven could become damaged if you incorrectly remove the door. Never pull the door horizontally off its retainers, as they will spring back against the oven.

- Raise the door up till it rests partially open.



- Hold the door on either side and pull it diagonally upwards off the retainers. Make sure that the door goes back on straight.

## Cleaning and care

---

### Dismantling the door

The oven door is an open system with 4 glass panes which have a heat-reflective coating on some of their surfaces.

When the oven is operating, air is directed through the door to keep the outer pane cool.

If soiling has worked its way in between the glass panes, the door can be dismantled in order to clean in between the panes.

Scratches on the door glass can cause the glass to break.

Do not use abrasive cleaners, hard sponges, brushes or sharp metal tools to clean the door glass.

When cleaning the door glass, you must also follow the instructions that apply to the oven front.

The different sides of the door glass have different coatings. The sides facing the oven compartment have heat-reflecting properties.

The oven could become damaged if you fit the door glass the wrong way round.

Make sure that you place the door glass back in the right position after cleaning.

Oven cleaners will damage the surface of the aluminium profiles.

Only clean these parts with warm water and washing-up liquid, applied with a clean sponge cloth or a clean, damp microfibre cloth.

The door glass could break if dropped.

Keep the disassembled door glass in a safe place.



## Cleaning and care

 Risk of injury caused by door slamming shut.

The door may slam shut if you attempt to disassemble it when it is fitted to the oven.

Always remove the door before disassembling it.

- Place the door with the outer glass pane on a soft surface (e.g. a tea towel) to prevent it getting scratched.

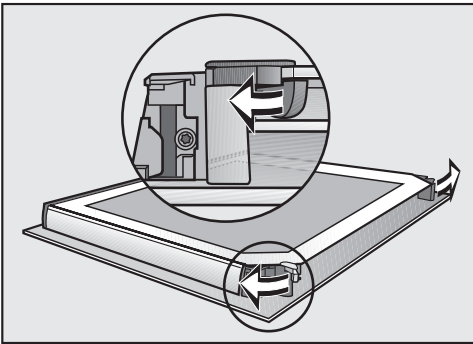

- Flip the two glass pane retainers outwards to open them.

You can now remove the inner panes and the two middle panes one after the other:

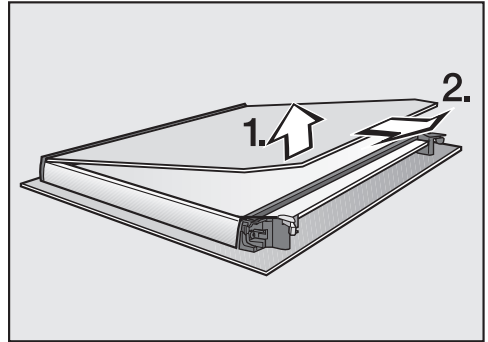

- **Gently** lift the inner pane up and out of the plastic strip.

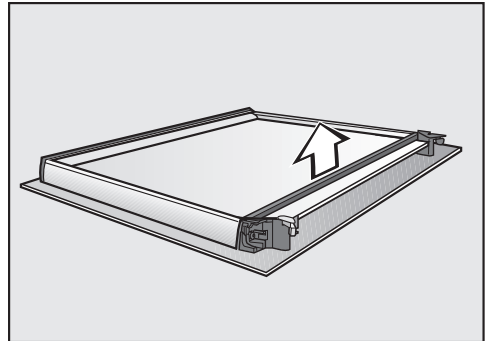

- Remove the seal.

## Cleaning and care

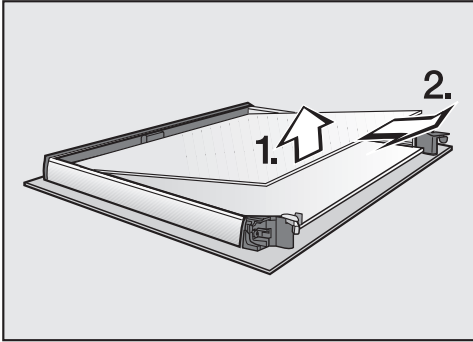

- Carefully lift the top of the two middle panes up and take it out.

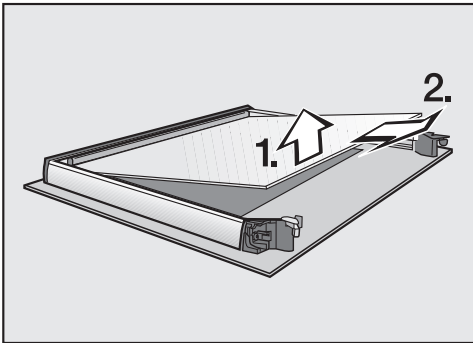

- Then lift the bottom of the two middle panes up carefully and take it out.
- Clean the door panes and other parts with a clean sponge and a solution of hot water and washing-up liquid or a clean, damp microfibre cloth.
- Dry all parts with a soft cloth.

Then reassemble the door carefully:

The two middle panes are identical. To help you put them back in correctly, the material number is printed on the panes.

- Refit the lower of the two middle panes in such a way that the material number is legible (i.e. not reversed).

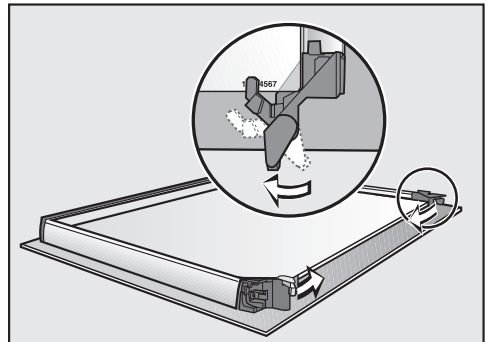

- Flip both the glass pane retainers inwards in such a way that they fit over the lower of the two middle panes.
- Refit the upper of the two middle panes in such a way that the material number is legible (i.e. not reversed). The pane must rest on the retainers.

## Cleaning and care

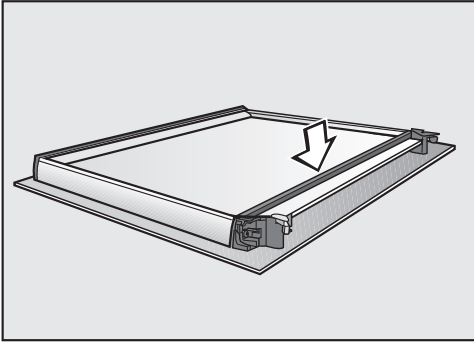

- Refit the seal.

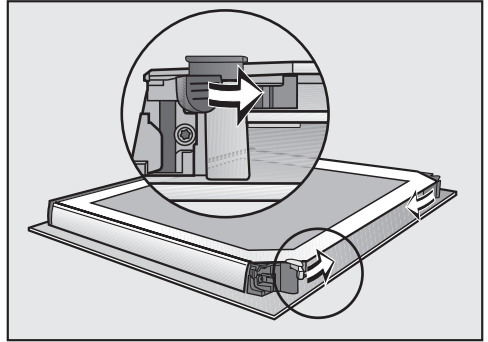

- Flip both the glass pane retainers inwards to close them.

The door is now reassembled.

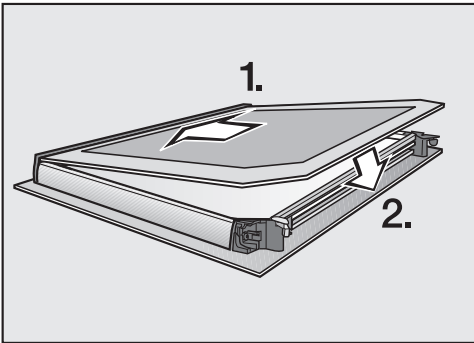

- Push the inner pane with the matt printed side facing downwards into the plastic strip and place it between the retainers.

# Cleaning and care

## Fitting the door

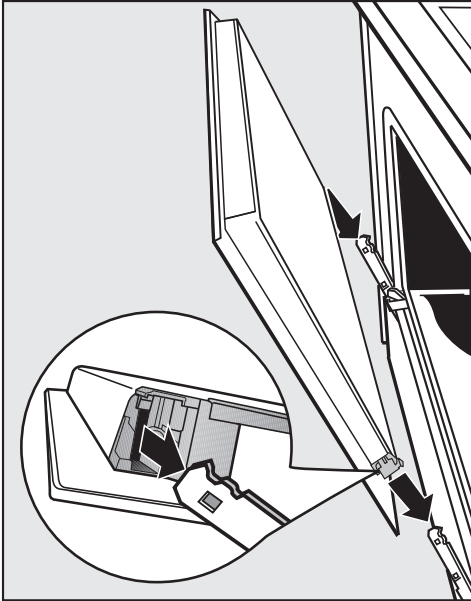

- Hold the door securely on both sides and carefully fit it back into the hinge retainers. Make sure that you fit the door straight.

- Open the door fully.

If the locking clamps are not locked, the door could become loose, resulting in damage.

Always ensure that the locking clamps are locked after refitting the door.

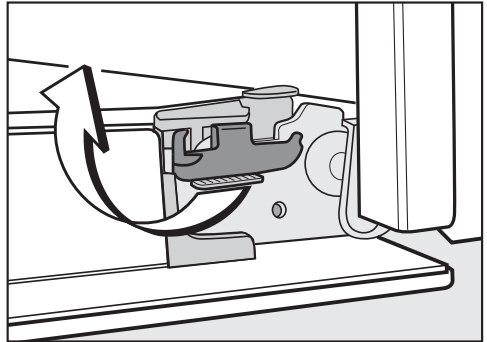

- To relock the locking clamps, turn them back up to the horizontal position as far as they will go.

### Removing the side runners with FlexiClip runners

The side runners can be removed together with the FlexiClip runners (if inserted).

If you wish to remove the FlexiClip runners separately beforehand, please follow the instructions in “Features” – “Fitting and removing FlexiClip runners”.

**⚠** Danger of injury caused by hot surfaces.

The oven gets hot during operation. You could burn yourself on the heating elements, oven compartment or accessories.

Allow the heating elements, oven compartment and accessories to cool before removing the side runners.

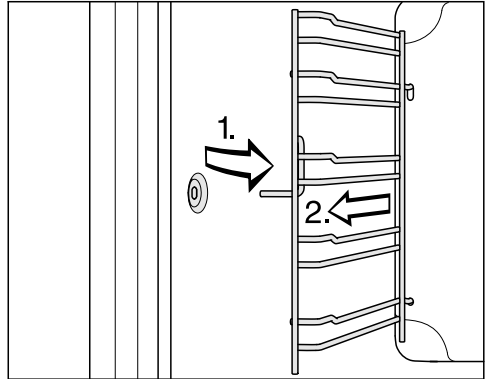

- Pull the side runners out of holder (1.) and remove them (2.).

**Reassemble** by following these instructions in reverse order.

- Insert the components carefully.

## Cleaning and care

### Lowering the top heat/grill element

If the oven compartment roof is badly soiled, the top heat/grill element can be lowered to make cleaning easier. Clean the oven compartment roof regularly with a damp cloth or a dishwashing sponge.

**⚠** Danger of injury caused by hot surfaces.

The oven gets hot during operation. You could burn yourself on the heating elements, oven compartment or accessories.

Allow the heating elements, oven compartment and the accessories to cool before manual cleaning.

The enamel on the oven floor can become damaged by fastening nuts being dropped on it.

Place a cloth or similar item over the oven compartment floor to protect it.

- Remove the side runners.

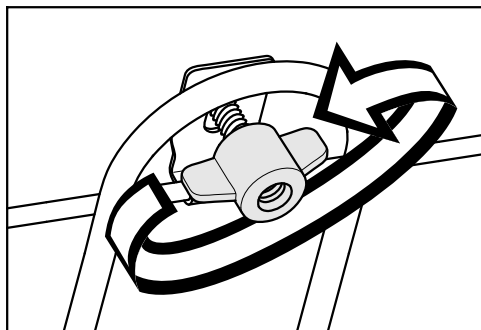

- Unscrew the wing nut.

Be careful not to damage the top heat/grill element.

Never use force when lowering the top heat/grill element.

- Carefully lower the top heat/grill element.

You can now access the top of the oven compartment.

- Clean the top of the oven compartment with hot water and washing-up liquid, applied with a clean sponge cloth or a clean, damp microfibre cloth.

Incorrectly fitting the covering pane can damage the camera.

Never unscrew the pane covering the camera.

- Remove any residues from the cover of the camera. You can use the scouring pad on the back of a washing-up sponge.
- After cleaning, raise the top heat/grill element gently back up again.
- Replace the wing nut and tighten it securely.
- Fit the shelf runners.

# Problem solving guide

Many malfunctions and faults that can occur in daily operation can be easily remedied. Time and money will be saved because a service call will not be needed.

The following guide may help you to find the reason for a malfunction or a fault, and to correct it.



Problem	Cause and remedy
<b>The display is dark.</b>	You have selected the <b>Time   Display   Off</b> setting. When the oven is switched off, the display is dark. <b>■</b> As soon as the oven is switched on, the main menu will appear. If you want the time of day to be displayed constantly, select the <b>Time   Display   On</b> setting.
	There is no power to the oven. <b>■</b> Check whether the fuse has tripped. Contact a qualified electrician or the Miele Customer Service Department.
<b>The buzzer does not sound.</b>	The buzzers are deactivated or set at too low a volume. <b>■</b> Switch on the buzzers or increase the volume with <b>Settings   Volume   Buzzer tones</b> .
<b>The oven compartment does not heat up.</b>	Demo mode is active. You can select menu options in the display and the sensor controls, but the oven heating does not work. <b>■</b> Deactivate demo mode by selecting <b>Settings   Showroom programme   Demo mode   Off</b> .

## Problem solving guide







Problem	Cause and remedy
<b>The sensor controls or the movement sensor do not respond.</b>	<p>You have selected the <b>Display   QuickTouch   Off</b> setting. When the oven is switched off, the sensor controls and the movement sensor do not respond.</p> <ul style="list-style-type: none"><li>■ As soon as the oven is switched on, the sensor controls and the movement sensor will respond. If you want the sensor controls and the movement sensor to respond even when the oven is switched off, select the <b>Display   QuickTouch   On</b> setting.</li></ul>
	<p>The settings for the movement sensor are switched off.</p> <ul style="list-style-type: none"><li>■ Change the settings for the movement sensor by selecting <b>Settings   Proximity sensor</b>.</li></ul>
	<p>The movement sensor is defective.</p> <ul style="list-style-type: none"><li>■ Call the Miele Customer Service Department.</li></ul>
	<p>The oven is not connected to the power supply.</p> <ul style="list-style-type: none"><li>■ Check that the oven plug is correctly inserted into the socket and switched on.</li><li>■ Check whether the fuse has tripped. Contact a qualified electrician or the Miele Customer Service Department.</li></ul>
	<p>If the display does not respond, there is a fault with the controls.</p> <ul style="list-style-type: none"><li>■ Touch and hold the <b>⓪ On/Off</b> button until the display switches off and the oven restarts.</li></ul>



## Problem solving guide

Problem	Cause and remedy
<p><b>You cannot open the door with the  sensor control.</b></p>	<p>You have selected the Display   QuickTouch   Off setting. The  sensor control does not respond when the oven is switched off.</p> <ul style="list-style-type: none"> <li>■ As soon as the oven is switched on, the sensor controls will respond. If you want the sensor controls to respond even when the oven is switched off, select the Display   QuickTouch   On setting.</li> </ul>
	<p>The oven is not connected to the power supply.</p> <ul style="list-style-type: none"> <li>■ Check that the oven plug is correctly inserted into the socket and switched on.</li> <li>■ Check whether the fuse has tripped. Contact a qualified electrician or the Miele Customer Service Department.</li> <li>■ If you need to open the door, for instance because there is still food in the oven compartment, use the opener supplied to prise the door open. To do so, push the opener at an angle into the gap on the outside edge of the door at the top between the control panel and the door. You can also pull the door open by grasping the sides of the door with both hands and pulling carefully until it opens.</li> </ul>
	<p>The pyrolytic cleaning programme has started.</p> <div style="border: 1px solid gray; padding: 10px; margin: 10px 0;"> <p> <b>Danger of injury caused by hot surfaces.</b>            During pyrolytic cleaning, the door will remain locked until the temperature inside the oven compartment drops to below 280 °C.            Do not attempt to prise open the door with the opener as described above!</p> </div> <ul style="list-style-type: none"> <li>■ Wait until the oven has cooled down. The door will unlock itself automatically as soon as the temperature in the oven compartment has dropped below 280 °C.</li> </ul>



## Problem solving guide

Problem	Cause and remedy
System lock  appears in the display when the oven is switched on.	<p>The  system lock has been activated.</p> <ul style="list-style-type: none"> <li>■ You can deactivate the system lock for a cooking programme by touching the  symbol for at least 6 seconds.</li> <li>■ If you want to permanently deactivate the system lock, select the <i>Safety   System lock    Off</i> setting.</li> </ul>
Power cut -process cancelled appears in the display.	<p>There has been a brief power cut. This has caused the current cooking programme to stop.</p> <ul style="list-style-type: none"> <li>■ Switch the oven off and then back on again.</li> <li>■ Restart the cooking programme.</li> </ul>
12:00 appears in the display.	<p>The power supply was interrupted for longer than 150 hours.</p> <ul style="list-style-type: none"> <li>■ Reset the time and date.</li> </ul>
Maximum operating hours reached appears in the display.	<p>The oven has been operating for an unusually long time. This has triggered the safety switch-off function.</p> <ul style="list-style-type: none"> <li>■ Confirm with <i>OK</i>.</li> </ul> <p>The oven is now ready to use.</p>
 Fault F32 appears in the display.	<p>The door lock for pyrolytic cleaning has not locked.</p> <ul style="list-style-type: none"> <li>■ Switch the oven off and then back on again. Start the pyrolytic cleaning programme again.</li> <li>■ If the message appears again, contact the Miele Customer Service Department.</li> </ul>
 Fault F33 appears in the display.	<p>The door lock for pyrolytic cleaning has not opened.</p> <ul style="list-style-type: none"> <li>■ Switch the oven off and then back on again.</li> <li>■ If the door lock still does not deactivate itself, contact the Miele Customer Service Department.</li> </ul>
Fault and a fault code not listed here appears in the display.	<p>A fault has occurred that you cannot resolve.</p> <ul style="list-style-type: none"> <li>■ Call the Miele Customer Service Department.</li> </ul>
No signal to food probe. Reposition food probe in the oven. appears in the display.	<p>The food probe is not being recognised.</p> <ul style="list-style-type: none"> <li>■ Change the position of the food probe in the food.</li> </ul> <p>If the food probe is still not being recognised, it is faulty. You can purchase a new food probe from your Miele dealer or from the Miele Customer Service Department.</p>

## Problem solving guide

Problem	Cause and remedy
Function currently not available <b>appears in the display after selecting the Descale function.</b>	The steam injection system is faulty. <ul style="list-style-type: none"> <li>■ Call the Miele Customer Service Department.</li> </ul>
Fault with moisture control the automatic programmes will run without moisture <b>appears in the display after selecting an automatic programme.</b>	The steam injection system is faulty. <ul style="list-style-type: none"> <li>■ Call the Miele Customer Service Department. Automatic programmes can be run without using moisture assistance.</li> </ul>
<b>Programmes using moisture assistance are not taking in water.</b>	Demo mode is active. You can select menu options in the display and the sensor controls, but the steam injection system pump will not work. <ul style="list-style-type: none"> <li>■ Deactivate demo mode by selecting Settings   Showroom programme   Demo mode   Off.</li> </ul>
	The pump for the steam injection system is faulty. <ul style="list-style-type: none"> <li>■ Call the Miele Customer Service Department.</li> </ul>
<b>A noise can be heard after a cooking programme.</b>	The cooling fan remains switched on after a cooking programme (see “Settings – Cooling fan run-on”).
<b>The oven has switched itself off.</b>	To save power, the oven switches off automatically if a button is not pressed after a certain amount of time or after a cooking programme has ended. <ul style="list-style-type: none"> <li>■ Switch the oven back on.</li> </ul>
<b>Cakes and biscuits are not baked properly after following the times given in the baking chart.</b>	A different temperature from the one given in the recipe was used. <ul style="list-style-type: none"> <li>■ Select the temperature required for the recipe.</li> </ul>
	The ingredient quantities are different from those given in the recipe. <ul style="list-style-type: none"> <li>■ Check whether you amended the recipe. The addition of more liquid or more eggs makes a moister mix which requires a longer cooking duration.</li> </ul>

## Problem solving guide

Problem	Cause and remedy
<b>The browning of the baked goods is uneven.</b>	<p>The wrong temperature or shelf level was selected.</p> <ul style="list-style-type: none"> <li>There will always be a slight unevenness in browning. If browning is very uneven, check whether the correct temperature and shelf level were selected.</li> </ul>
	<p>The material or colour of the bakeware is not suitable for the oven function selected.</p> <ul style="list-style-type: none"> <li>When using the Conventional heat  function, light coloured, shiny tins will not produce as desirable results. Dark, matt tins are best for baking.</li> </ul>
<b>There is still soiling in the oven compartment after a pyrolytic cleaning programme.</b>	<p>The pyrolytic cleaning programme burns off soiling in the oven and leaves it as ash.</p> <ul style="list-style-type: none"> <li>Remove the ash using a damp microfibre cloth or with a clean sponge and a solution of hot water and washing-up liquid.</li> </ul> <p>If there is still coarse soiling left in the oven after the pyrolytic cleaning programme you should start the programme again, selecting a longer duration if necessary.</p>
<b>The accessories make noises when being pushed into or pulled out of the oven.</b>	<p>The pyrolytic resistant surface of the side runners creates friction when accessories are being pushed into or pulled out of the oven.</p> <ul style="list-style-type: none"> <li>To reduce the friction, add a few drops of heat resistant cooking oil to some kitchen paper and use this to lubricate the side runners. Repeat this after every pyrolytic cleaning programme.</li> </ul>
<b>The oven interior lighting switches off after a short time.</b>	<p>You have selected the Lighting   "On" for 15 seconds setting.</p> <ul style="list-style-type: none"> <li>If you want the oven interior lighting to be switched on during the entire cooking programme, select the Lighting   On setting.</li> </ul>
<b>The oven interior lighting is off or does not switch on.</b>	<p>You have selected the Lighting   Off setting.</p> <ul style="list-style-type: none"> <li>Press the  sensor control to switch on the oven interior lighting for 15 seconds.</li> <li>If required, select the Lighting   On or "On" for 15 seconds setting.</li> </ul>
	<p>The oven interior lighting is faulty.</p> <ul style="list-style-type: none"> <li>Call the Miele Customer Service Department.</li> </ul>

## Contact in case of malfunction

In the event of any faults which you cannot remedy yourself, please contact your Miele Dealer or Miele Service.

Contact information for Miele Service can be found at the end of this document.

Please note that telephone calls may be monitored and recorded for training purposes and that a call-out charge will be applied to service visits where the problem could have been resolved as described in this booklet.

Please quote the model and serial number of your appliance when contacting Miele. This information can be found on the data plate.

This information is given on the data plate, which is visible on the front frame of the oven when the door is fully open.

## Warranty

For information on the appliance warranty specific to your country please contact Miele. See back cover for address.

In the UK, your appliance warranty is valid for 2 years from the date of purchase. However, you must activate your cover by calling 0330 160 6640 or registering online at [www.miele.co.uk](http://www.miele.co.uk).

# Installation

## Installation dimensions

Dimensions are given in mm.

### Installation in a tall or base unit

When building the oven into a base unit underneath a hob, please also observe the installation instructions for the hob as well as the building-in depth required for the hob.

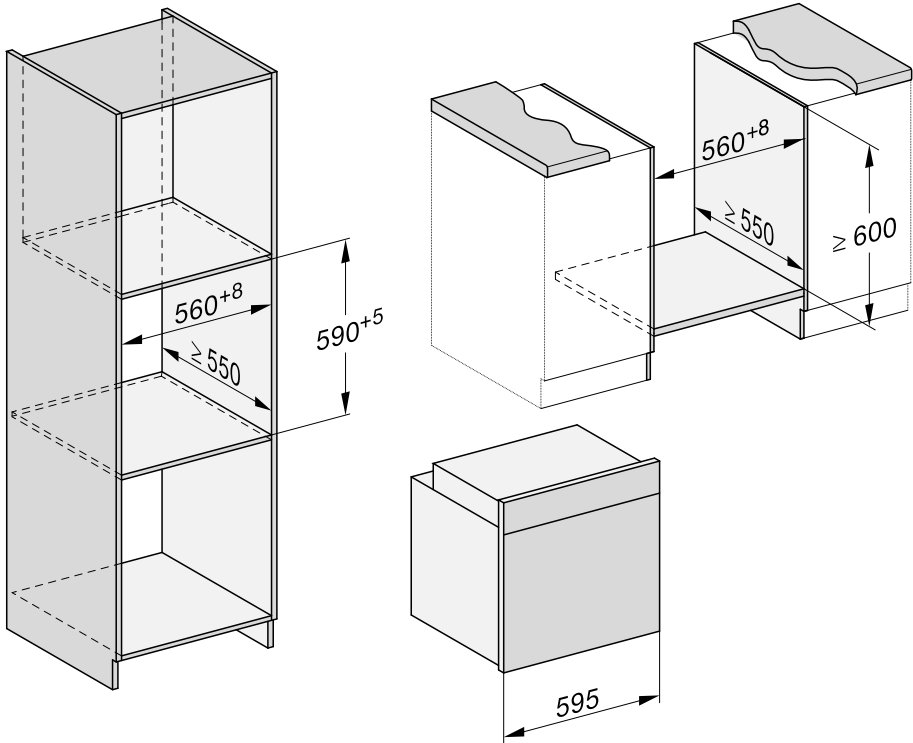

## Side view

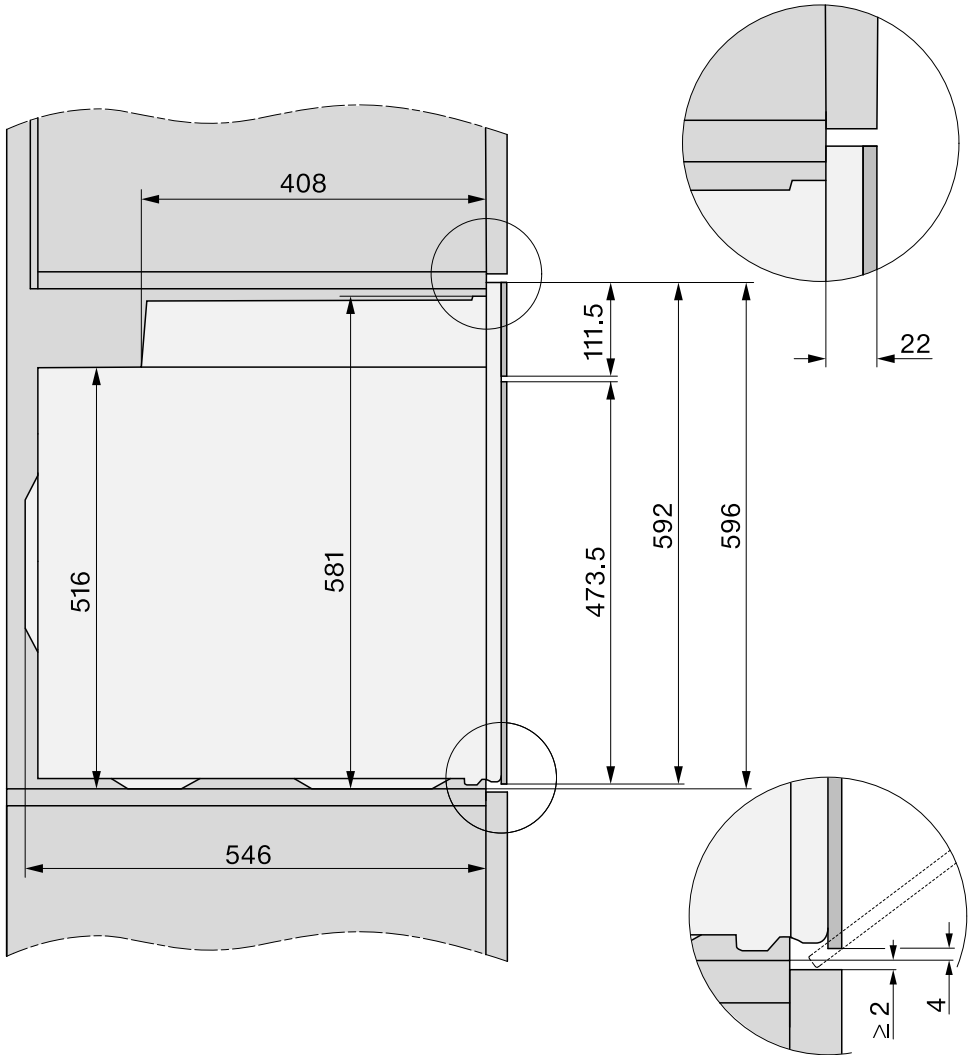

# Installation

## Connections and ventilation

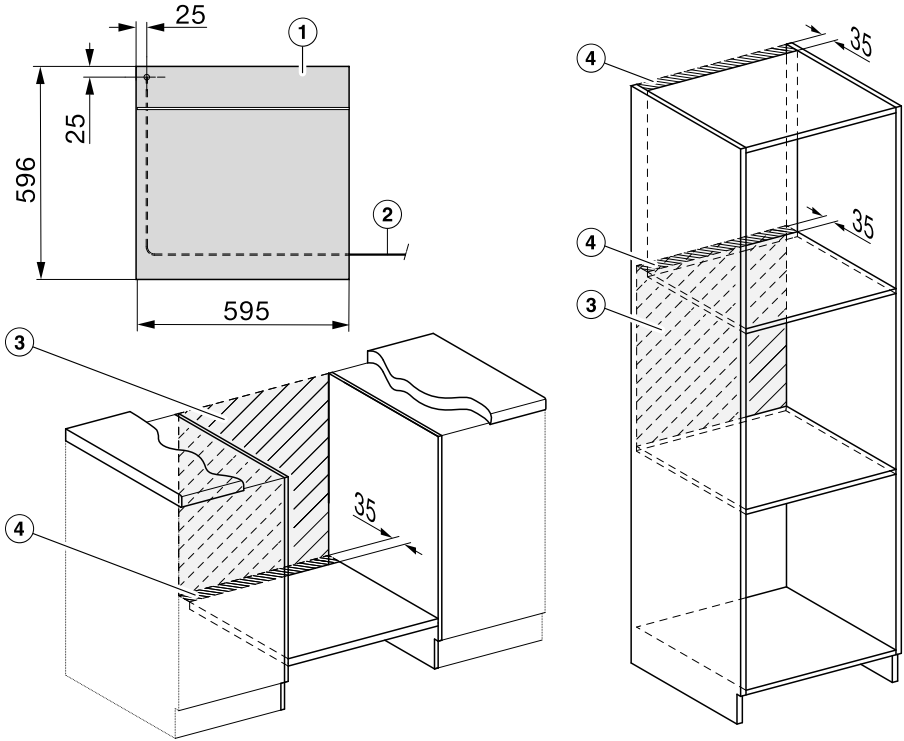

- ① Front view
- ② Mains connection cable, length = 2000 mm
- ③ No connections permitted in this area
- ④ Ventilation cut-out, min. 150 cm<sup>2</sup>



## Installing the oven

For safety reasons, the oven may only be used when it has been fully installed.

The oven requires a sufficient supply of cool air for efficient operation. The required supply of cool air must not be excessively heated by other heat sources (e.g. solid fuel stoves).

The following must be observed when installing the appliance:

Make sure that the shelf that the oven sits on does not touch the wall. Do not fit heat insulation strips to the side walls of the housing unit.

- Connect the oven to the electrical supply.

Use the handle cut-outs on the side of the housing to lift the appliance. It is a good idea to remove the door (see “Cleaning and care” – “Door removal”) and to remove the accessories before installing the appliance. This makes the oven lighter when you push it into the housing unit.

- To remove the door, use the opener supplied to prise the door open. You can also pull the door open by grasping the sides of the door with both hands and pulling carefully until it opens.
- Remove the door (see “Cleaning and care” – “Door removal”) and take the accessories out of the oven.
- Push the oven into the housing unit and align it.

- Reconnect the mains power to the isolator switch.
- Touch the  sensor control to open the door if you have not removed it already.

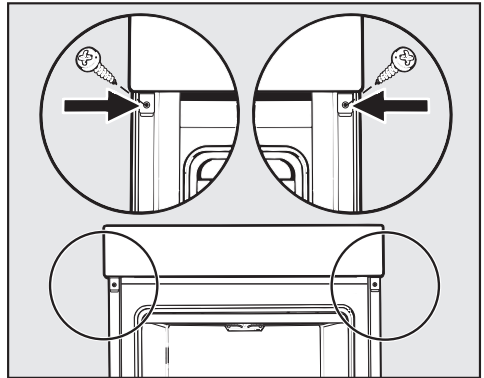

- Use the screws supplied to secure the oven to the side walls of the housing unit.
- Refit the door if necessary (see “Cleaning and care” – “Fitting the door”).

# Installation

## Electrical connection

 **Danger of injury!**  
Installation, repairs and other work by unqualified persons could be dangerous. Miele cannot be held liable for unauthorised work.

Connection to the electrical supply must be carried out by a suitably qualified and competent person in accordance with local and national safety regulations. Ensure power is not supplied to the appliance until after installation or repair work has been carried out.

All electrical work should be carried out by a suitably qualified and competent Miele approved service technician in strict accordance with current national and local safety regulations (BS 7671 in the UK).

Connection should be made via a fused connection unit or a suitable isolator, which complies with national and local safety regulations, and the on/off switch should be easily accessible after the appliance has been installed.

If the switch is not accessible after installation (depending on country) an additional means of disconnection must be provided for all poles.

Switches with a minimum all-pole contact gap of 3 mm are suitable for isolating the appliance. These include circuit breakers, fuses and protective devices.

## Connection data

The required connection data are given on the data plate located on the oven trim visible when the door is open.

Ensure that these match the mains supply.

- When contacting Miele, please quote the following:
  - Model number
  - Serial number
  - Connection data (voltage/frequency/maximum connected load)

When replacing the cable supplied with another cable or changing the connection, only cable type H05VV-F with a suitable cross-sectional area (CSA) may be used.

## Oven

The wires in the mains lead are coloured as follows:

Green/yellow = earth

Blue = neutral

Brown = live

 **WARNING - THIS APPLIANCE MUST BE EARTHED**

For extra safety it is advisable to protect the appliance with a suitable residual current device (RCD).

Maximum connected load: see data plate.

## Electrical connection: Other countries

All electrical work should be carried out by a suitably qualified and competent Miele approved service technician in strict accordance with local and national safety regulations.

Connection should be made via a fused connection unit or a suitable isolator, which complies with national and local safety regulations, and the on/off switch should be easily accessible after the appliance has been installed.

If the switch is not accessible after installation (depending on country) an additional means of disconnection must be provided for all poles.

Switches with a minimum all-pole contact gap of 3 mm are suitable for isolating the appliance. These include circuit breakers, fuses and protective devices.

The voltage and rated load are given on the data plate situated at the front of the oven interior. Please ensure that these match the household mains supply.

For extra safety it is advisable to install a suitable residual current device (RCD) / ground fault interrupter (GFI). Contact a qualified electrician for advice.

If the cord is damaged a new cord must be fitted by a Miele approved service technician.

## Hong Kong

This appliance is supplied with a power cord with plug for connection to a 230 V, 50 Hz socket outlet.























## Taiwan







This appliance is supplied with a power cord with plug for connection to a 220 V, 60 Hz socket outlet.

 **WARNING - THIS APPLIANCE  
MUST BE EARTHED**

# Cooking charts

## Batter

Cakes/biscuits (accessories)		 [°C]		 <sup>5</sup> <sub>1</sub>	 [min]	CF
Muffins (1 tray)		150–160	–	2	25–35	–
Muffins (2 trays)		150–160	–	1+3	30–40 <sup>2</sup>	–
Small cakes (1 tray) *		150	–	2	30–40	–
		160 <sup>1</sup>	–	3	20–30	–
Small cakes (2 trays) *		150 <sup>1</sup>	–	1+3	25–35	–
Madeira cake (loaf tin, 30 cm)		150–160	–	2	60–70	–
		155–165 <sup>1</sup>	–	2	60–70	✓
Marble, nut cake (loaf tin, 30 cm)		150–160	–	2	60–70	–
		150–160	–	2	60–70	–
Marble, nut cake (ring tray, bundt cake tin, Ø 26 cm)		150–160	✓	2	55–65	–
		150–160	✓	2	60–70	–
Fresh fruit cake (tray)		150–160	–	2	40–50	✓
		155–165	–	1	40–50	✓
Fresh fruit cake (springform cake tin, Ø 26 cm)		150–160	✓	2	55–65	✓
		165–175 <sup>1</sup>	–	2	50–60	✓
Flan base (flan base tin, Ø 28 cm)		150–160	–	2	25–35	–
		170–180 <sup>1</sup>	–	2	15–25	–

























 Function,  Temperature,  Booster,  <sup>5</sup><sub>1</sub> Shelf level,  Cooking duration, CF Crisp function,  Fan plus,  Conventional heat, ✓ On, – Off









\* The settings also apply for testing in accordance with EN 60350-1.

<sup>1</sup> Pre-heat the oven compartment before putting in the food.

<sup>2</sup> Take the trays out of the oven early if the food is sufficiently browned before the specified cooking duration has elapsed.

## Rubbed in mixture

Cakes/biscuits (accessories)		 [°C]		 5 1	 [min]	CF
Biscuits (1 tray)		140–150	–	2	25–35	–
		150–160	–	2	25–35	–
Biscuits (2 trays)		140–150	–	1+3	25–35 <sup>2</sup>	–
Drop cookies (1 tray) *		140	–	2	30–40	–
		160 <sup>1</sup>	–	3	20–30	–
Drop cookies (2 trays) *		140	–	1+3	35–45 <sup>2</sup>	–
Flan base (flan base tin, Ø 28 cm)		150–160	✓	2	35–45	–
		170–180 <sup>1</sup>	✓	2	20–30	–
Cheese cake (springform tin, Ø 26 cm)		170–180	–	2	80–90	–
		160–170	–	2	80–90	–
Apple pie (springform tin, Ø 20 cm)*		160	–	2	90–100	–
		180	–	1	80–90	–
Apple pie with top crust (springform tin, Ø 26 cm)		180–190 <sup>1</sup>	–	2	60–70	✓
		160–170	–	2	60–70	✓
Fresh fruit cake with glaze (springform cake tin, Ø 26 cm)		170–180	–	2	60–70	–
		150–160	–	2	55–65	–
Fresh fruit cake, with glaze (tray)		170–180	–	2	50–60	✓
		160–170	–	2	45–55	✓
Swiss apple pie (tray)		210–220 <sup>1</sup>	✓	1	45–55	✓
		190–200	–	2	40–50	✓

 Function,  Temperature,  Booster,  Shelf level,  Cooking duration, CF Crisp function,  Fan plus,  Eco fan heat,  Conventional heat,  Intensive bake, ✓ On, – Off























\* The settings also apply for testing in accordance with EN 60350-1.







1 Pre-heat the oven compartment before putting in the food.

2 Take the trays out of the oven early if the food is sufficiently browned before the specified cooking duration has elapsed.

# Cooking charts









## Yeast dough







Cakes/biscuits (accessories)		 [°C]		 <sup>5</sup> <sub>1</sub>	 [min]	CF
Bundt cake (bundt cake tin, Ø 24 cm)		150–160	–	2	50–60	–
		160–170	–	2	50–60	–
Stollen		150–160	–	2	55–65	–
		160–170	✓	2	55–65	–
Streusel cake with/without fruit (tray)		160–170	–	2	35–45	✓
		170–180	–	3	45–55	✓
Fresh fruit cake (tray)		160–170	✓	2	45–55	✓
		170–180	✓	3	45–55	✓
Apple turnovers/raisin whirls (1 tray)		160–170	✓	2	25–35	–
Apple turnovers/raisin whirls (2 trays)		160–170	✓	1+3	30–40 <sup>3</sup>	–
White loaf (free form)		190–200	✓	2	30–40 <sup>4</sup>	–
		190–200	–	2	30–40	–
White bread (loaf tin, 30 cm)		180–190	✓	2	45–55	–
		190–200 <sup>1</sup>	✓	2	55–65 <sup>5</sup>	✓ <sup>6</sup>
Wholegrain bread (loaf tin, 30 cm)		180–190	✓	2	55–65	–
		200–210 <sup>1</sup>	✓	2	55–65 <sup>5</sup>	✓ <sup>6</sup>
Proving yeast dough		30–35	–	– <sup>2</sup>	–	–

 Function,  Temperature,  Booster,  <sup>5</sup><sub>1</sub> Shelf level,  Cooking duration, CF Crisp function,  Fan plus,  Moisture plus + Fan plus,  Moisture plus + Conventional heat,  Conventional heat, ✓ On, – Off

- 1 Pre-heat the oven compartment before putting in the food.
- 2 Place the rack on the floor of the oven, and stand the bowl containing the dough on the rack. Depending on the size of the dish, you may need to remove the shelf runners.
- 3 Take the trays out of the oven early if the food is sufficiently browned before the specified cooking duration has elapsed.
- 4 Release 1 burst of steam at the beginning of the cooking programme.
- 5 Release 2 bursts of steam at the beginning of the cooking programme.
- 6 Turn on the crisp function 15 minutes into the cooking duration.











## Quark dough

Cakes/biscuits (accessories)		 [°C]		 <sup>5</sup> <sub>1</sub>	 [min]	CF
Fresh fruit cake (tray)		160–170	✓	2	45–55	✓
		170–180	✓	3	45–55	✓
Apple turnovers/raisin whirls (1 tray)		160–170	–	3	25–35	✓
Apple turnovers/raisin whirls (2 trays)		150–160	✓	1+3	25–35 <sup>1</sup>	✓

 Function,  Temperature,  Booster,  <sup>5</sup><sub>1</sub> Shelf level,  Cooking duration, CF Crisp function,  Fan plus,  Conventional heat, ✓ On, – Off

<sup>1</sup> Take the trays out of the oven early if the food is sufficiently browned before the specified cooking duration has elapsed.

## Sponge mixture

Cakes/biscuits (accessories)		 [°C]		 <sup>5</sup> <sub>1</sub>	 [min]	CF
Sponge cake base (2 eggs, springform tin, Ø 26 cm)		160–170 <sup>1</sup>	–	2	15–25	–
Sponge cake base (4–6 eggs, springform tin, Ø 26 cm)		150–160 <sup>1</sup>	–	2	30–40	–
Whisked sponge (springform tin, Ø 26 cm) *		180	–	2	25–35	–
		150–170 <sup>1</sup>	–	2	25–45	–
Swiss roll sponge (tray)		180–190 <sup>1</sup>	✓	1	15–25	–













 Function,  Temperature,  Booster,  <sup>5</sup><sub>1</sub> Shelf level,  Cooking duration, CF Crisp function,  Fan plus,  Conventional heat, ✓ On, – Off





\* The settings also apply for testing in accordance with EN 60350-1.

<sup>1</sup> Pre-heat the oven compartment before putting in the food.

# Cooking charts

## Choux pastry, puff pastry, meringue

Cakes/biscuits (accessories)		 [°C]		 5 1	 [min]	CF
Choux buns (1 tray)		160–170	–	2	30–40	✓
		160–170	–	2	25–35 <sup>1</sup>	✓ <sup>2</sup>
Palermo style pastry puffs (1 tray)		180–190	–	2	20–30	–
Palermo style pastry puffs (2 trays)		180–190	–	1+3	20–30 <sup>3</sup>	–
Macaroons (1 tray)		120–130	–	2	25–50	✓
Macaroons (2 trays)		120–130	–	1+3	25–50 <sup>3</sup>	✓
Meringue/pavlova (1 tray, 6 pcs, Ø 6 cm each)		80–100	–	2	120–150	✓
Meringue/pavlova (2 trays, each with 6 pcs, Ø 6 cm each)		80–100	–	1+3	150–180	✓

 Function,  Temperature,  Booster,  Shelf level,  Cooking duration, CF Crisp function,  Fan plus,  Moisture plus + Fan plus, ✓ On, – Off

\* The settings also apply for testing in accordance with EN 60350-1.



















<sup>1</sup> Release 1 burst of steam 8 minutes into the cooking programme.











<sup>2</sup> Turn on the crisp function 15 minutes into the cooking duration.

<sup>3</sup> Take the trays out of the oven early if the food is sufficiently browned before the specified cooking duration has elapsed.



## Savoury dishes

Food to be cooked (accessories)		 [°C]		 <sup>5</sup> <sub>1</sub>	 [min]	CF
Savoury tart (tray)		220–230 <sup>3</sup>	✓	1	30–40	✓
		180–190	–	1	45–55	✓
Onion tart (tray)		180–190 <sup>3</sup>	✓	2	25–35	✓
		170–180	–	2	30–40	✓
Pizza, yeast dough (tray)		170–180	✓	2	25–35	✓
		210–220 <sup>3</sup>	–	2	20–30	✓
Pizza, quark-oil dough (tray)		170–180	✓	2	25–35	✓
		190–200 <sup>3</sup>	✓	3	25–35	✓
Frozen pizza, pre-cooked (rack)		200–210	–	2	25–25	–
Toast * (rack)		300	–	3	5–8	–
Grilled items (e.g. toast) <sup>1</sup>	 <sup>2</sup>	275 <sup>4</sup>	–	3	3–6	–
Grilled vegetables <sup>1</sup>	 <sup>2</sup>	275 <sup>4</sup>	–	4	5–10 <sup>5</sup>	✓
		250 <sup>4</sup>	–	3	5–10 <sup>5</sup>	✓
Ratatouille (universal tray)		180–190	–	2	40–60	–

 Function,  Temperature,  Booster, <sup>5</sup><sub>1</sub> Shelf level,  Cooking duration, CF Crisp function,  Fan plus,  Eco fan heat,  Conventional heat,  Intensive bake,  Full grill,  Fan grill, ✓ On, – Off

\* The settings also apply for testing in accordance with EN 60350-1.

<sup>1</sup> Use the rack and universal tray.

<sup>2</sup> Depending on the amount, you can also use the Economy grill  function.



















<sup>3</sup> Pre-heat the oven compartment before putting in the food.











<sup>4</sup> Pre-heat the oven compartment for 5 minutes before putting in the food.

<sup>5</sup> Turn the food ideally after half of the cooking duration has elapsed.

# Cooking charts

## Beef

Food (accessories)		 [°C]		 5 1	 [min]	 [°C]
Braised beef, approx. 1 kg (oven dish with lid)	 <sup>2</sup>	150–160 <sup>3</sup>	✓	2	120–130 <sup>5</sup>	--
	 <sup>2</sup>	170–180 <sup>3</sup>	✓	2	120–130 <sup>5</sup>	--
	 <sup>2</sup>	180–190	–	2	160–180 <sup>6</sup>	--
Fillet of beef, approx. 1 kg (universal tray)	 <sup>2</sup>	180–190 <sup>3</sup>	✓	2	25–60	45–75
Fillet of beef, “rare”, approx. 1 kg <sup>1</sup>	 <sup>2</sup>	80–85	–	2	70–80	45–48
Fillet of beef, “medium”, approx. 1 kg <sup>1</sup>	 <sup>2</sup>	90–95	–	2	80–90	54–57
Fillet of beef, “well done”, approx. 1 kg <sup>1</sup>	 <sup>2</sup>	95–100	–	2	110–130	63–66
Sirloin joint, approx. 1 kg (universal tray)	 <sup>2</sup>	180–190 <sup>3</sup>	✓	2	35–65	45–75
Sirloin joint, “rare”, approx. 1 kg <sup>1</sup>	 <sup>2</sup>	80–85	–	2	80–90	45–48
Sirloin joint, “medium”, approx. 1 kg <sup>1</sup>	 <sup>2</sup>	90–95	–	2	110–120	54–57
Sirloin joint, “well done”, approx. 1 kg <sup>1</sup>	 <sup>2</sup>	95–100	–	2	130–140	63–66
Burgers, patties <sup>*1</sup>	 <sup>2</sup>	300 <sup>4</sup>	–	4	12–24 <sup>7</sup>	--

 Function,  Temperature,  Booster,  Shelf level,  Cooking duration,  Core temperature,  Auto roast,  Conventional heat,  Eco fan heat,  Low temperature cooking special application,  Full grill, ✓ On, – Off

\* The settings also apply for testing in accordance with EN 60350-1.

<sup>1</sup> Use the rack and universal tray.

<sup>2</sup> Sear the meat on the hob first.

<sup>3</sup> Pre-heat the oven before putting food inside.















<sup>4</sup> Pre-heat the oven for 5 minutes before putting food inside.









<sup>5</sup> Roast with the lid on first. Then remove the lid after roasting for 90 minutes and add approx. 0.5 litres of liquid.

<sup>6</sup> Roast with the lid on first. Then remove the lid after roasting for 100 minutes and add approx. 0.5 litres of liquid.

<sup>7</sup> Turn the food halfway through cooking.

## Veal



















Food to be cooked (accessories)		 [°C]		 <sup>5</sup> 1	 [min]	 [°C]
Braised veal, approx. 1.5 kg (oven dish with lid)	 <sup>2</sup>	160–170 <sup>3</sup>	✓	2	120–130 <sup>4</sup>	--
	 <sup>2</sup>	170–180 <sup>3</sup>	✓	2	120–130 <sup>4</sup>	--
Fillet of veal, approx. 1 kg (universal tray)	 <sup>2</sup>	160–170 <sup>3</sup>	✓	2	30–60	45–75
Fillet of veal, pink, approx. 1 kg <sup>1</sup>	 <sup>2</sup>	80–85	–	2	50–60	45–48
Fillet of veal, medium, approx. 1 kg <sup>1</sup>	 <sup>2</sup>	90–95	–	2	80–90	54–57
Fillet of veal, well done, approx. 1 kg <sup>1</sup>	 <sup>2</sup>	95–100	–	2	90–100	63–66
Saddle of veal, pink, approx. 1 kg <sup>1</sup>	 <sup>2</sup>	80–85	–	2	80–90	45–48
Saddle of veal, medium, approx. 1 kg <sup>1</sup>	 <sup>2</sup>	90–95	–	2	100–130	54–57
Saddle of veal, well done, approx. 1 kg <sup>1</sup>	 <sup>2</sup>	95–100	–	2	130–140	63–66













 Function,  Temperature,  Booster, <sup>5</sup> Shelf level,  Cooking duration,  Core temperature,  Auto roast,  Conventional heat,  Special low temperature cooking,  
 ✓ On, – Off

- 1 Use the rack and universal tray.
- 2 Sear the meat on the hob first.
- 3 Pre-heat the oven compartment before putting in the food.
- 4 Roast with the lid on first. Remove the lid 90 minutes into the cooking duration and add approx. 0.5 litres of liquid.

# Cooking charts













## Pork

Food to be cooked (accessories)		 Temperature [°C]	 Booster	 Shelf <sup>5</sup>	 Cooking duration [min]	 Core temperature [°C]
Pork roast/pork shoulder, approx. 1 kg (oven dish with lid)		160–170	✓	2	130–140 <sup>5</sup>	80–90
		170–180	✓	2	130–140 <sup>5</sup>	80–90
Roast pork with crackling, approx. 2 kg (oven dish)		180–190	✓	2	130–150 <sup>6,7,8</sup>	80–90
		190–200	✓	2	130–150 <sup>7,8</sup>	80–90
Fillet of pork, approx. 350 g <sup>1</sup>		90–100	–	2	70–90	63–69
Ham roast, approx. 1.5 kg (oven dish with lid)		160–170	–	2	130–160 <sup>9</sup>	80–90
Gammon joint, approx. 1 kg (universal tray)		150–160	✓	2	50–60 <sup>6</sup>	63–68
Gammon joint, approx. 1 kg <sup>1</sup>		95–105	–	2	140–160	63–66
Meat loaf, approx. 1 kg (universal tray)		170–180	✓	2	60–70 <sup>7</sup>	80–85
		190–200	✓	2	70–80 <sup>7</sup>	80–85
Bacon <sup>1</sup>		300 <sup>4</sup>	–	4	3–5	--
Sausage <sup>1</sup>		220 <sup>4</sup>	–	3	8–15 <sup>10</sup>	--

 Function,  Temperature,  Booster,  Shelf<sup>5</sup>,  Cooking duration,  Core temperature,  Auto roast,  Conventional heat,  Eco fan heat,  Moisture plus + Fan plus,  Special low temperature cooking,  Full grill, ✓ On, – Off

- 1 Use the rack and universal tray.
- 2 Sear the meat on the hob first.
- 3 Turn on the Crisp function.  
Depending on the amount, you can also use the Economy grill  function.
- 4 Pre-heat the oven compartment for 5 minutes before putting in the food.
- 5 Roast with the lid on first. Remove the lid 60 minutes into the cooking duration and add approx. 0.5 litres of liquid.
- 6 Over the cooking duration, release a burst of steam 3 times manually after the heating-up phase.
- 7 Add approx. 0.5 litres of liquid halfway through the cooking duration.
- 8 Turn on the Crisp function 60 minutes into the cooking duration.
- 9 Roast with the lid on first. Remove the lid 100 minutes into the cooking duration and add approx. 0.5 litres of liquid.
- 10 Turn the food halfway through cooking.

## Lamb, game















Food to be cooked (accessories)		 [°C]		 5 1	 [min]	 [°C]
Leg of lamb, on the bone, approx. 1.5 kg (oven dish with lid)		170–180	–	2	100–120 <sup>3</sup>	64–82
Saddle of lamb, off the bone (universal tray)	 <sup>1</sup>	180–190 <sup>2</sup>	✓	2	10–20	53–80
Saddle of lamb, off the bone (rack and universal tray)	 <sup>1</sup>	95–105	–	2	40–60	54–66
Saddle of venison, off the bone (universal tray)	 <sup>1</sup>	160–170 <sup>2</sup>	–	2	70–90	60–81
Roebuck saddle, off the bone (universal tray)	 <sup>1</sup>	140–150 <sup>2</sup>	–	2	25–35	60–81
Leg of wild boar, off the bone, approx. 1 kg (oven dish with lid)	 <sup>1</sup>	170–180	–	2	100–120 <sup>3</sup>	80–90











 Function,  Temperature,  Booster, <sup>5</sup> Shelf level,  Cooking duration,  Core temperature,  Conventional heat,  Special low temperature cooking, ✓ On, – Off

- <sup>1</sup> Sear the meat on the hob first.
- <sup>2</sup> Pre-heat the oven compartment before putting in the food.
- <sup>3</sup> Roast with the lid on first. Remove the lid 50 minutes into the cooking duration and add approx. 0.5 litres of liquid.

# Cooking charts

















## Poultry, fish

Food to be cooked (accessories)		 [°C]		 5 1	 [min]	 [°C]
Poultry, 0.8–1.5 kg (universal tray)		170–180	✓	2	55–65	85–90
Chicken, approx. 1.2 kg (rack on universal tray)		180–190 <sup>1</sup>	–	2	60–70 <sup>3</sup>	85–90
Poultry, approx. 2 kg (oven dish)		180–190	✓	2	100–120 <sup>4</sup>	85–90
		190–200	✓	3	100–120 <sup>4</sup>	85–90
Poultry, approx. 4 kg (oven dish)		160–170	✓	2	180–200 <sup>5</sup>	90–95
		180–190	✓	2	180–200 <sup>5</sup>	90–95
Fish, 200–300 g (e.g. trout) (universal tray)		210–220 <sup>2</sup>	–	2	15–25 <sup>6</sup>	75–80
Fish, 1–1.5 kg (e.g. salmon trout) (universal tray)		210–220 <sup>2</sup>	–	2	30–40 <sup>6</sup>	75–80
Fish fillet in foil, approx. 200–300 g (universal tray)		200–210	–	2	25–30	75–80

 Function,  Temperature,  Booster,  Shelf level,  Cooking duration,  Core temperature,  Auto roast,  Fan grill,  Conventional heat,  Moisture plus + Conventional heat,  Eco fan heat, ✓ On, – Off

- 1 Pre-heat the oven compartment for 5 minutes before putting in the food.
- 2 Pre-heat the oven compartment before putting in the food.
- 3 Turn the food half way through grilling.
- 4 Add approx. 0.25 litres of liquid at the start of the cooking programme.
- 5 Add approx. 0.5 litres of liquid after 30 minutes.
- 6 Release 1 manual burst of steam 5 minutes into the cooking programme.

## Test food acc. to EN 60350-1

Test food (accessories)		 [°C]		 <sup>5</sup>	 [min]	CF
Small cakes (1 baking tray <sup>1</sup> )		150	-	2	30-40	-
		160 <sup>4</sup>	-	3	20-30	-
Small cakes (2 baking trays <sup>1</sup> )		150 <sup>4</sup>	-	1+3	25-35	-
Drop cookies (1 baking tray <sup>1</sup> )		140	-	2	30-40	-
		160 <sup>4</sup>	-	3	20-30	-
Drop cookies (2 baking trays <sup>1</sup> )		140	-	1+3	35-45 <sup>6</sup>	-
Apple pie (rack <sup>1</sup> , springform tin <sup>2</sup> , Ø 20 cm)		160	-	2	90-100	-
		180	-	2	80-90	-
Whisked sponge (rack <sup>1</sup> , springform tin <sup>2</sup> , Ø 26 cm)		180	-	2	25-35	-
	 <sup>3</sup>	150-170 <sup>4</sup>	-	2	25-45	-
Toast (rack <sup>1</sup> )		300	-	3	5-8	-
Burgers (rack <sup>1</sup> on universal tray <sup>1</sup> )		300 <sup>5</sup>	-	4	12-24 <sup>7</sup>	-

 Function,  Temperature,  Booster, <sup>5</sup> Shelf level,  Cooking duration, CF Crisp function,  Fan plus,  Conventional heat,  Full grill, ✓ On, - Off

<sup>1</sup> Only use original Miele accessories.

<sup>2</sup> Use a dark, matt springform tin.  
Place the springform tin on the rack in the centre.

<sup>3</sup> In general, if a range of temperatures is given, it is best to select the lower temperature and to check the food after the shortest cooking duration.

<sup>4</sup> Pre-heat the oven compartment before putting in the food.

<sup>5</sup> Pre-heat the oven compartment for 5 minutes before putting in the food.

<sup>6</sup> Take the trays out of the oven early if the food is sufficiently browned before the specified cooking duration has elapsed.

<sup>7</sup> Turn the food ideally after half of the cooking duration has elapsed.

# Notes for test institutes

## Energy efficiency class according to EN 60350-1

The energy efficiency rating is determined in accordance with EN 60350-1.

Energy efficiency rating: A+

Please observe the following when conducting testing:

- Testing is undertaken using the Eco Fan heat  function.
- Select the Lighting | "On" for 15 seconds setting (see "Settings" – "Lighting").
- Select the Proximity sensor | Switch light on | Off setting (see "Settings", – "Proximity sensor (movement sensor)").

– Only accessories that are required for testing should be in the oven compartment during tests.

Do not use other accessories that might be available such as FlexiClip runners or catalytic enamelled panels such as side panels or roof liners.

– An important pre-condition for determining the energy efficiency rating is that the door is tightly shut during testing.

Depending on measurement devices used, the functioning of the door seal can be affected to a greater or lesser extent. This has a negative impact on the test results.

Pushing against the door will compensate for this. In certain unfavourable circumstances, suitable technical aids may also be necessary for this. This does not occur in normal use.

## Data sheet for household ovens

In acc. with delegated regulation (EU) No. 65/2014 and regulation (EU) No. 66/2014

<b>MIELE</b>	
<b>Model name/identifier</b>	H 7860 BPX
Energy efficiency index/cavity (EEI <sub>cavity</sub> )	81,7
Energy efficiency class/cavity	
A+++ (most efficient) to D (least efficient)	A+
Energy consumption per cycle for each cavity in conventional mode	1,10 kWh
Energy consumption per cycle for each cavity in fan-forced convection mode	0,71 kWh
Number of cavities	1
Heat source(s) per cavity	electric
Volume of cavity	76 l
Mass of the appliance	47,0 kg



## Conformity declaration

---

Miele hereby declares that this oven complies with Directive 2014/53/EU.

The complete text of the EU declaration of conformity is available from one of the following internet addresses:

- Products, Download from [www.miele.co.uk](http://www.miele.co.uk)
- For service, information, operating instructions etc: go to [www.miele.co.uk/domestic/customer-information-385.htm](http://www.miele.co.uk/domestic/customer-information-385.htm) and enter the name of the product or the serial number

Frequency band of the WiFi module	2.4000 GHz – 2.4835 GHz
-----------------------------------	-------------------------

Maximum transmission power of the WiFi module	< 100 mW
---	----------

Frequency band of the food probe	433.2 MHz – 434.6 MHz
----------------------------------	-----------------------

Maximum transmission power of the food probe	< 10 mW
--	---------

# Copyrights and Licences

---

Miele uses their own and third party software which is not subject to any so-called Open Source Licence for the operation and control of the appliance. This software/ these software components are protected by copyright. The copyright powers of Miele and third parties have to be respected.

Furthermore, this appliance contains software components which are distributed under Open Source licence conditions. Please refer to [Settings | Legal information | Open Source licences](#) in the appliance for the Open Source components contained therein, together with the corresponding copyright notices, copies of the licence terms valid at the time, and any further information. The liability and warranty provisions of the Open Source licence terms and conditions as stated therein apply only in relation to the respective rights holders.

In particular, the appliance contains software components licenced by the copyright holders under the GNU General Public License, Version 2, or the GNU Lesser General Public License, Version 2.1. For a period of at least 3 years from the date of purchase or delivery of the appliance respectively, Miele offers to provide you or third parties with a machine-readable copy of the source code of the Open Source components contained in the appliance and licenced under the terms of the GNU General Public License, Version 2, or the GNU Lesser General Public License, Version 2.1, on a data carrier (CD-ROM, DVD or USB stick). Please contact us via e-mail ([info@miele.com](mailto:info@miele.com)) or the below postal address and state the product name, the serial number and the date of purchase to obtain this source code.

Miele & Cie. KG  
Open Source  
GTZ/TIM  
Carl-Miele-Straße 29  
33332 Gütersloh

Please note the limited warranty in favour of the rights holders under the terms of the GNU General Public License, Version 2, and the GNU Lesser General Public License, Version 2.1:

*This program is distributed in the hope that it will be useful, but WITHOUT ANY WARRANTY, without even the implied warranty of MERCHANTABILITY of FITNESS FOR A PARTICULAR PURPOSE. See the GNU General Public License and GNU Lesser General Public License for more details.*



## United Kingdom

Miele Co. Ltd.  
Fairacres, Marcham Road  
Abingdon, Oxon, OX14 1TW  
Tel: 0330 160 6600  
Internet: [www.miele.com](http://www.miele.com)

## Australia

Miele Australia Pty. Ltd.  
ACN 005 635 398  
ABN 96 005 635 398  
1 Gilbert Park Drive  
Knoxfield, VIC 3180  
Tel: 1300 464 353  
Internet: [www.miele.com.au](http://www.miele.com.au)

## China

Miele (Shanghai) Trading Ltd.  
1-3 Floor, No. 82 Shi Men Yi Road  
Jing' an District  
200040 Shanghai, PRC  
Tel: +86 21 6157 3500  
Fax: +86 21 6157 3511  
E-mail: [info@miele.cn](mailto:info@miele.cn)  
Internet: [www.miele.cn](http://www.miele.cn)

## Miele (Hong Kong) Limited

41/F - 4101, Manhattan Place  
23 Wang Tai Road  
Kowloon Bay, Hong Kong  
Tel: (852) 2610 1025  
Fax: (852) 3579 1404  
Email:  
[customerservices@miele.com.hk](mailto:customerservices@miele.com.hk)  
Website: [www.miele.hk](http://www.miele.hk)

## India

Miele India Pvt. Ltd.  
Ground Floor  
Copia Corporate Suites  
Plot No. 9, Jasola  
New Delhi - 110025  
Tel: 011-46 900 000  
Fax: 011-46 900 001  
E-mail: [customercare@miele.in](mailto:customercare@miele.in)  
Internet: [www.miele.in](http://www.miele.in)

## Ireland

Miele Ireland Ltd.  
2024 Bianconi Avenue  
Citywest Business Campus  
Dublin 24  
Tel: (01) 461 07 10  
Fax: (01) 461 07 97  
E-Mail: [info@miele.ie](mailto:info@miele.ie)  
Internet: [www.miele.ie](http://www.miele.ie)

## Malaysia

Miele Sdn Bhd  
Suite 12-2, Level 12  
Menara Sapura Kencana  
Petroleum  
Solaris Dutamas No. 1  
Jalan Dutamas 1  
50480 Kuala Lumpur, Malaysia  
Phone: +603-6209-0288  
Fax: +603-6205-3768

## New Zealand

Miele New Zealand Limited  
IRD 98 463 631  
Level 2, 10 College Hill  
Freemans Bay, Auckland 1011  
New Zealand  
Tel: 0800 464 353  
Internet: [www.miele.co.nz](http://www.miele.co.nz)

## Singapore

Miele Pte. Ltd.  
163 Penang Road  
# 04 - 03 Winsland House II  
Singapore 238463  
Tel: +65 6735 1191  
Fax: +65 6735 1161  
E-Mail: [info@miele.com.sg](mailto:info@miele.com.sg)  
Internet: [www.miele.sg](http://www.miele.sg)

## South Africa

Miele (Pty) Ltd  
63 Peter Place, Bryanston 2194  
P.O. Box 69434, Bryanston 2021  
Tel: (011) 875 9000  
Fax: (011) 875 9035  
E-mail: [info@miele.co.za](mailto:info@miele.co.za)  
Internet: [www.miele.co.za](http://www.miele.co.za)

## Taiwan

K.E. & Kingstone Co., Ltd.  
6th Fl., No. 120, Sec. 2  
Jianguo N. Rd.  
Taipei, Taiwan  
TEL: +886 2 2502-7256  
FAX: +886 2 2502-3077  
E-mail: [kenk@kenk.com.tw](mailto:kenk@kenk.com.tw)  
Website:  
[www.kenk.com.tw/ke/miele](http://www.kenk.com.tw/ke/miele)

## Thailand

BHIRAJ TOWER at EmQuartier  
43rd Floor Unit 4301-4303  
689 Sukhumvit Road  
North Klongton Sub-District  
Vadhana District  
Bangkok 10110, Thailand

## United Arab Emirates

Miele Appliances Ltd.  
Gold & Diamond Park  
Office No. 6-217  
Sheikh Zayed Road  
P.O. Box 11 47 82 - Dubai  
Tel. +971 4 3044 999  
Fax. +971 4 3418 852  
800-MIELE (64353)  
E-Mail: [info@miele.ae](mailto:info@miele.ae)  
Website: [www.miele.ae](http://www.miele.ae)

**Manufacturer:** Miele & Cie. KG, Carl-Miele-Straße 29, 33332 Gütersloh, Germany

H 7860 BPX

en-GB

M.-Nr. 11 194 160 / 01