

Operating and installation instructions Steam ovens



To avoid the risk of accidents or damage to the appliance it is **essential** to read these instructions before it is installed and used for the first time.

Contents

Warning and Safety instructions	6
Caring for the environment	14
Guide to the appliance	15
Steam oven	15
Accessories supplied	16
Controls	17
On/Off sensor control.....	18
Display.....	18
Sensor controls	18
Symbols.....	20
Using the appliance	21
Selecting a menu option	21
Changing a setting in a list.....	21
Changing the setting with a segment bar	21
Selecting a function or operating mode	22
Entering numbers	23
Entering letters	23
Activating MobileStart	23
Description of functions	24
Water container	24
Condensate tray	24
Temperature	24
Cooking duration.....	24
Noises.....	24
Heating-up phase.....	25
Cooking phase	25
Steam reduction	25
Oven interior lighting	25
Before using for the first time	26
Miele@home.....	26
Basic settings.....	27
Cleaning for the first time	28
Set the correct boiling point for water.....	29
Settings	30
Settings overview	30
Opening the “Settings” menu.....	32
Language 	32
Time.....	32

Date	33
Lighting.....	33
Display.....	33
Volume.....	34
Units	34
Keeping warm	35
Steam reduction	35
Recommended temperatures.....	35
Water hardness	36
Safety	37
Miele@home.....	38
Remote control.....	39
Activating MobileStart	39
Remote update.....	39
Software version.....	40
Showroom programme.....	40
Factory default.....	40
Minute minder	41
Main and sub-menus	43
Operation	44
Changing values and settings for a cooking programme.....	45
Changing the temperature.....	46
Setting cooking durations	46
Changing the set cooking durations	48
Deleting the set cooking durations.....	48
Interrupting a cooking programme.....	49
Cancelling a cooking programme	50
General notes	51
The advantages of cooking with steam	51
Suitable containers.....	51
Condensate tray	51
Shelf level	52
Frozen food.....	52
Temperature	52
Cooking duration.....	52
Cooking with liquid.....	52
Your own recipes.....	52
Steam cooking	53
Eco Steam cooking	53

Contents

Notes on the cooking tables	53
Vegetables.....	54
Fish.....	57
Meat	60
Rice	62
Grain.....	63
Pasta	64
Dumplings	65
Dried pulses	66
Hen's eggs	68
Fruit	69
Sausages.....	69
Shellfish.....	70
Mussels	71
Menu cooking (cooking whole meals).....	72
Sous-vide (vacuum) cooking.....	74
Further applications	82
Reheat	82
Defrost.....	85
Blanching.....	88
Bottling	88
Disinfect items	91
Prove dough	91
Heating damp flannels	92
Dissolve gelatine	92
Decrystallise honey	93
Melt chocolate.....	93
Make yoghurt	94
Cook bacon.....	95
Sweat onions.....	95
Extracting juice with steam	96
Skinning vegetables and fruit.....	97
Apple storage	97
Making eierstich	97
Automatic programmes	98
Categories	98
Using automatic programmes.....	98
User programmes.....	99
Note for test institutes	102

Cleaning and care	103
Cleaning the steam oven front	104
Cleaning the oven compartment	104
Cleaning the water container	105
Accessories	105
Cleaning the side runners.....	106
Descaling the steam oven	106
Problem solving guide	108
Optional accessories	111
Service	112
Contact in case of malfunction	112
Warranty	112
Installation	113
Safety instructions for installation	113
Building-in dimensions	114
Installation in a tall unit.....	114
Installation in a base unit.....	115
Side view	116
Connection and ventilation.....	117
Installing the steam oven.....	118
Electrical connection	119
Conformity declaration	121

Warning and Safety instructions

This steam oven complies with all applicable safety requirements. Inappropriate use can, however, lead to personal injury and material damage.

Read the operating and installation instructions carefully before using the steam oven. They contain important information on safety, installation, use and maintenance. This prevents both personal injury and damage to the steam oven.

In accordance with standard IEC/EN 60335-1, Miele expressly and strongly advises that you read and follow the instructions in the chapter on installing the steam oven as well as the safety instructions and warnings.

Miele cannot be held liable for injury or damage caused by non-compliance with these instructions.

Keep these instructions in a safe place and pass them on to any future owner.

Correct application

- ▶ This steam oven is intended for use in domestic households and similar working and residential environments.
- ▶ This steam oven is not intended for outdoor use.
- ▶ The steam oven is intended for domestic use only to steam-cook, defrost and reheat food.
All other types of use are not permitted.
- ▶ The steam oven can only be used by people with reduced physical, sensory or mental capabilities, or lack of experience and knowledge, if they are supervised whilst using it, or have been shown how to use it in a safe way and recognise and understand the consequences of incorrect operation.
- ▶ This steam oven is supplied with a special lamp to cope with particular conditions (e.g. temperature, moisture, chemical resistance, abrasion resistance and vibration). This special lamp must only be used for the purpose it is intended for. It is not suitable for room lighting. Replacement lamps may only be fitted by a Miele authorised person or by Miele Service.

Warning and Safety instructions

Safety with children

- ▶ Activate the system lock to ensure that children cannot switch on the steam oven inadvertently.
- ▶ Children under 8 years of age must be kept away from the steam oven unless they are constantly supervised.
- ▶ Children aged 8 and older may only use the steam oven without supervision if they have been shown how to use it in a safe manner. Children must be able to understand and recognise the possible dangers caused by incorrect operation.
- ▶ Children must not be allowed to clean the steam oven unsupervised.
- ▶ Please supervise children in the vicinity of the steam oven and do not let them play with it.
- ▶ Risk of suffocation due to packaging material. Whilst playing, children may become entangled in packaging material (such as plastic wrapping) or pull it over their head, presenting the risk of suffocation. Keep packaging material away from children.
- ▶ Risk of injury caused by hot surfaces and steam. Children's skin is far more sensitive to high temperatures than that of adults. During operation, steam will escape out of the ventilation outlet. The door glass and control panel of the steam oven heats up. Do not let children touch the steam oven when it is in operation. Keep children well away from the steam oven until it has cooled down and there is no danger of injury.
- ▶ Risk of injury from the open door. The oven door can support a maximum weight of 8 kg. Children could injure themselves on an open door. Do not let children sit on the open door, lean against it or swing on it.

Technical safety

- ▶ Unauthorised installation, maintenance and repairs can cause considerable danger for the user. Installation, maintenance and repairs must only be carried out by a Miele authorised technician.
- ▶ Never use a damaged steam oven. It could be dangerous. Check it for visible signs of damage before using it.
- ▶ Reliable and safe operation of this steam oven can only be assured if it has been connected to the mains electricity supply.
- ▶ The electrical safety of this appliance can only be guaranteed when correctly earthed. It is essential that this standard safety requirement is met. If in any doubt please have the electrical installation tested by a qualified electrician.
- ▶ Before connecting the appliance to the mains supply, ensure that the connection data on the data plate (voltage and frequency) match the mains electricity supply.
This data must correspond in order to avoid the risk of damage to the appliance. Consult a qualified electrician if in any doubt.
- ▶ Do not connect the steam oven to the mains electricity supply by a multi-socket adapter or an extension lead. These do not guarantee the required safety of the appliance (fire hazard).
- ▶ For safety reasons, this steam oven may only be used when it has been built in. This is necessary to ensure that all electrical components are shielded.
- ▶ This steam oven must not be used in a non-stationary location (e.g. on a ship).
- ▶ Never open the casing of the appliance. Tampering with electrical connections or components and mechanical parts is highly dangerous to the user and can cause operational faults.

Warning and Safety instructions

- ▶ While the appliance is under warranty, repairs should only be undertaken by a Miele authorised service technician. Otherwise the warranty is invalidated.
- ▶ Miele can only guarantee the safety of the appliance when genuine original Miele replacement parts are used. Faulty components must only be replaced by Miele spare parts.
- ▶ If the plug is removed from the connection cable or if the cable is supplied without a plug, the appliance must be connected to the electrical supply by a suitably qualified electrician.
- ▶ If the connection cable is damaged, it must be replaced with a special connection cable (see “Electrical connection”).
- ▶ During installation, maintenance and repair work, the appliance must be disconnected from the mains electricity supply.
- ▶ If the steam oven is installed behind a furniture front (e.g. a door), do not close the furniture front while the steam oven is in use. Heat and moisture can build up behind the furniture front when closed. This can result in damage to the steam oven, the housing unit and the floor. Leave the furniture door open until the steam oven has cooled down completely.
- ▶ In areas which may be subject to infestation by cockroaches or other vermin, pay particular attention to keeping the appliance and its surroundings clean at all times. Any damage caused by cockroaches or other vermin will not be covered by the warranty.

Correct use

▶ Risk of injury caused by hot surfaces and steam. The steam oven gets hot during operation. You could burn yourself on the oven compartment, side runners, accessories, food or steam.

Wear oven gloves when placing hot food in the oven or removing it and when adjusting oven shelves, for example, in a hot oven compartment.

▶ Risk of injury caused by hot food.

Food may spill or splash around when placing it into the oven or removing it. The food can cause burns.

When placing cooking containers into the oven or removing them, make sure that the hot food does not spill.

▶ Risk of injury caused by hot water.

At the end of a cooking programme, hot water left in the steam generator is pumped back into the water container. Take care not to tip the water container when taking it out of the appliance.

▶ Do not use the steam oven to heat up or bottle food in sealed jars and tins.

Pressure will build up inside them and they can explode causing damage to the appliance, as well as the risk of injury and scalding.

▶ Plastic dishes which are not heat and steam-resistant melt at high temperatures and can damage the appliance.

Use only heat-resistant (to 100 °C) and steam-resistant plastic dishes. Follow the manufacturer's instructions.

▶ Food which is stored in the oven compartment can dry out and the moisture released can lead to corrosion damage in the steam oven. Do not leave food in the oven compartment and do not use any cooking containers which are susceptible to corrosion.

▶ Risk of injury from the open door. You could bang into the open door or trip over it. Avoid leaving the door open unnecessarily.

Warning and Safety instructions

- ▶ The door can support a maximum weight of 8 kg. Do not sit on or lean against an open door, and do not place heavy objects on it. Also make sure that nothing can get trapped between the door and the oven cavity. The steam oven could get damaged.
- ▶ When using a small electrical appliance, e.g. a hand-held blender, near the steam oven, care should be taken that the cable of the appliance cannot get trapped by the steam oven door. The insulation on the cable could become damaged, giving rise to an electric shock hazard.

Cleaning and care

- ▶ Risk of injury due to electric shock. The steam from a steam cleaning appliance could reach live electrical components and cause a short circuit. Do not use a steam cleaner to clean the appliance.
- ▶ Scratches on the door glass can result in the glass breaking. Do not use abrasive cleaners, hard sponges, brushes or sharp metal tools to clean the door glass.
- ▶ The side runners can be removed (see “Cleaning and care – Cleaning the side runners”).
Refit the side runners correctly.
- ▶ Try to avoid the interior walls being splashed with food or liquids containing salt. If it does happen, wipe these away thoroughly to avoid corrosion to stainless steel surfaces inside the cabinet.

Accessories

- ▶ Only use genuine original Miele accessories and spare parts with this appliance. Using accessories or spare parts from other manufacturers will invalidate the warranty and Miele cannot accept liability.

Caring for the environment

Disposal of the packing material

The packaging is designed to protect the appliance from damage during transportation. The packaging materials used are selected from materials which are environmentally friendly for disposal and should be recycled.

Recycling the packaging reduces the use of raw materials in the manufacturing process and also reduces the amount of waste in landfill sites.

Disposing of your old appliance

Electrical and electronic appliances often contain valuable materials. They also contain specific materials, compounds and components, which were essential for their correct function and safety. These could be hazardous to human health and to the environment if disposed of with your domestic waste or if handled incorrectly. Please do not, therefore, dispose of your old appliance with your household waste.



Please dispose of it at your local community waste collection / recycling centre for electrical and electronic appliances, or contact your dealer or Miele for advice. You are also responsible (by law, depending on country) for deleting any personal data that may be stored on the appliance being disposed of. Please ensure that your old appliance poses no risk to children while being stored prior to disposal.

Steam oven

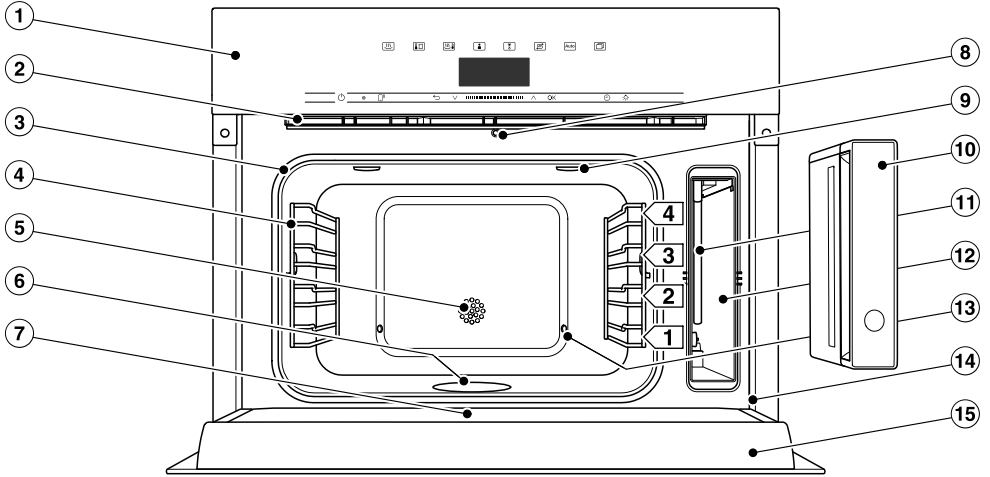

- ① Control elements
- ② Ventilation outlet
- ③ Door seal
- ④ Side runners with 4 shelf levels
- ⑤ Temperature sensor
- ⑥ Floor heater element
- ⑦ Drip channel
- ⑧ Automatic door release for steam reduction
- ⑨ LED oven interior lighting
- ⑩ Water container with removable spill guard
- ⑪ Suction tube
- ⑫ Compartment for water container
- ⑬ Steam inlet
- ⑭ Front frame with data plate
- ⑮ Door

Guide to the appliance

A list of the models described in these operating and installation instructions can be found on the back page.

Data plate

The data plate is located on the front frame, visible when the door is open.

The data plate states the model number, the serial number as well as connection data (voltage, frequency and maximum rated load).

Please have this information to hand, should you need to contact Miele regarding any questions or problems.

Accessories supplied

The accessories supplied with your appliance as well as a range of optional ones are available to order from Miele (see "Optional accessories").

DGG 1/1-40 L

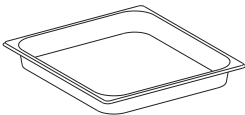

1 condensate tray
For collecting excess moisture.
You can also use the condensate tray as a cooking container.
375 x 394 x 40 mm (W x D x H)

DGG 1/2-40L

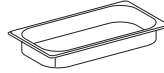

1 solid cooking container
Gross capacity 2.2 litres /
Usable capacity 1.6 litres
375 x 197 x 40 mm (W x D x H)

DGGL 1/2-40L

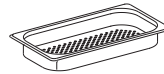

2 perforated cooking containers
Gross capacity 2.2 litres /
Usable capacity 1.6 litres
375 x 197 x 40 mm (W x D x H)

DMSR 1/1L



1 rack for placing your own crockery on

Descaling tablets

For descaling the appliance

Voucher/Miele steam oven cookbook

A selection of the best recipes from the Miele test kitchen

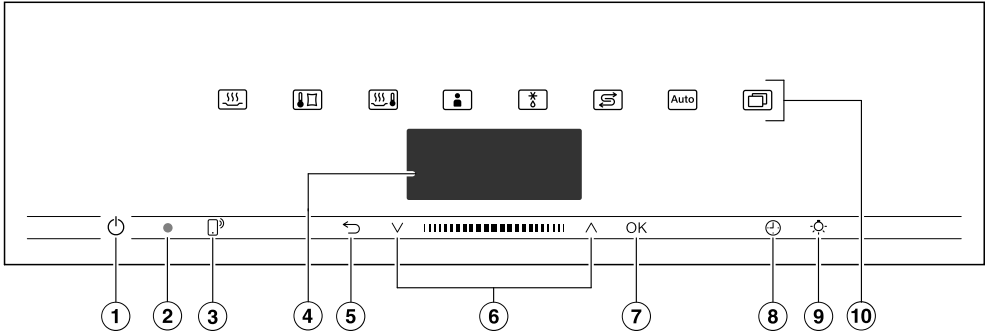

- ① Recessed ① On/Off control
For switching the steam oven on and off
- ② Optical interface
(For Miele Service only)
- ③ [Mobile Device Icon] sensor control
For controlling the steam oven via your mobile device
- ④ Display
For displaying the time of day and information on operation
- ⑤ ↶ sensor control
For going back a step and for changing menu options during a cooking programme
- ⑥ Navigation area with ^ and V arrow buttons
For scrolling through lists and for changing values
- ⑦ OK sensor control
For selecting functions and saving settings
- ⑧ ⌚ sensor control
For setting a minute minder, the cooking duration or the start or end time for the cooking programme
- ⑨ ☹ sensor control
For switching the oven interior lighting on and off
- ⑩ Sensor controls
For selecting functions, automatic programmes and settings

Controls

On/Off sensor control

The ① On/Off sensor control is recessed and reacts to touch.

Use this control to switch the steam oven on and off.

Display

The display is used for showing the time of day or information about functions, temperatures, cooking durations, automatic programmes and settings.

After switching the steam oven on with the ① On/Off sensor control, the main menu will appear, prompting you to Select function.

Sensor controls



The sensor controls react to touch. Every touch of a sensor control is confirmed with an audible tone. This audible tone can be switched off by selecting the Volume | Keypad tone | Off setting.

If you want the sensor controls to respond even when the steam oven is switched off, select the Display | Quick-Touch | On setting.



Sensor controls above the display

For information on the functions and operating modes, see “Main and sub-menus”, “Settings”, “Automatic programmes” and “Further applications”.

Sensor controls under the display





Sensor control	Function
	<p>If you want to control the steam oven from your mobile device, you must have the Miele@home system, switch on the Remote control setting and touch this sensor control. The sensor control then lights up orange and the MobileStart function is available.</p> <p>As long as this sensor control is lit, you can control the steam oven via your mobile device (see “Settings – Miele@home”).</p>
	<p>Depending on which menu you are in, this sensor control will take you back a level or back to the main menu.</p> <p>If a cooking programme is in progress at the same time, use this sensor control to change values and settings such as the temperature or cooking duration for the programme, or to cancel the programme.</p>
	<p>In the navigation area, use the arrow buttons or the area between them to scroll up or down in the selection lists. The menu options will be highlighted one after the other as you scroll through them. The desired menu option must be highlighted before you can select it.</p> <p>You can change the values or settings that are highlighted by using the arrow buttons or the area between them.</p>
<p>OK</p>	<p>Functions highlighted in the display can be selected by touching the OK sensor control. The selected function can then be changed.</p> <p>Confirm with OK to save changes.</p> <p>If information appears in the display, select OK to confirm the message.</p>

Controls

Sensor control	Function
	<p>If no cooking programme is in progress, you can use this sensor control to set a minute minder (e.g. when boiling eggs) at any point.</p> <p>If a cooking programme is in progress at the same time, you can set a minute minder, the cooking duration and a start or end time for the programme.</p>
	<p>Select this sensor control to switch the oven interior lighting on and off.</p> <p>Depending on the setting selected, the oven interior lighting switches off after 15 seconds or remains constantly switched on or off.</p>

Symbols

The following symbols may appear in the display:

Symbol	Meaning
	This symbol indicates that there is additional information and advice about using the appliance. Select <i>OK</i> to access the information.
	Minute minder
	A tick indicates the option which is currently selected.
	Some settings, e.g. display brightness and buzzer volume are selected using a bar chart.

Use the \wedge and \vee arrow buttons or the **|||||** area between them in the navigation area to use the steam oven.

As soon as you reach a value, message or setting you need to confirm, the *OK* sensor control will light up orange.

Selecting a menu option

- Touch the \wedge or \vee arrow buttons or swipe to the right or left in the **|||||** area until the desired menu option is highlighted.

Tip: If you press and hold the arrow button, the list continues scrolling automatically until you release the arrow button.

- Confirm your selection with *OK*.

Changing a setting in a list

- Touch the \wedge or \vee arrow buttons or swipe to the right or left in the **|||||** area until you reach the desired value or the desired setting is highlighted.

Tip: A \checkmark tick will appear beside the current setting.

- Confirm with *OK*.

The setting is now saved. This will take you back to the previous menu.

Changing the setting with a segment bar

Some settings are represented by a **■■■■■□□□** bar with seven segments. If all of the segments are illuminated, the maximum value is selected.

If none of the segments are illuminated, the minimum value is selected or the setting is switched off altogether (e.g. volume).

- Touch the \wedge or \vee arrow buttons or swipe to the right or left in the **|||||** area until you reach the desired setting.

- Confirm your selection with *OK*.

The setting is now saved. This will take you back to the previous menu.

Using the appliance

Selecting a function or operating mode

The sensor controls for the functions and operating modes (e.g. Further ) are located above the display (see “Controls” and “Settings”).

- Touch the sensor control for the desired function.

The sensor control on the fascia panel lights up orange.

- Under Further , scroll through the lists until the desired menu option is highlighted.
- Set the values for the cooking programme.
- Confirm with *OK*.

Changing the function

You can change to another function during a cooking programme.

The sensor control for the previously selected function lights up orange.

- Touch the sensor control of the new function or operating mode.
- Select *Change function? | Yes* and confirm with *OK*, if required.

The new function appears in the display with its corresponding recommended values.

The sensor control for the new function lights up orange.

Under Further , scroll through the lists until you reach the desired menu option.

Entering numbers

Numbers that can be changed are highlighted.

- Touch the \wedge or \vee arrow buttons or swipe to the right or left in the **||||** area until the desired number is highlighted.

Tip: If you press and hold an arrow button, the numbers continue scrolling automatically until you release the arrow button.

- Confirm with *OK*.

The changed number is now saved. This will take you back to the previous menu.

Entering letters

Letters are entered via the navigation area. It is best to select short names.

- Touch the \wedge or \vee arrow buttons or swipe to the right or left in the **||||** area until the desired character is highlighted.

The character you have selected will appear in the top line of the display.

Tip: A maximum of 10 characters can be used.

You can delete the characters one at a time with \leftarrow .

- Select the rest of the characters.
- Once you have entered the name, select \checkmark .
- Confirm with *OK*.

The name is now saved.

Activating MobileStart

- Select the  sensor control to activate MobileStart.

The  sensor control lights up. You can operate your steam oven remotely with the Miele@mobile app.

Directly operating the steam oven via the touch display takes priority over operating it via the remote control function on the app.

You can use MobileStart as long as the  sensor control is lit up.

Description of functions

Water container

The maximum filling volume is 1.5 litres and the minimum is 0.5 litres. There are markings on the water container. The upper marking must never be exceeded.

Water consumption depends on the type of food and the duration of cooking. The water may need to be topped up during cooking. Water consumption is increased if the door is opened during cooking.

The water container is removed using a push/pull system: push gently on the water container to remove it.

At the end of a cooking programme, hot water left in the steam generator is pumped back into the water container. The water container must be emptied after each use involving steam.

Condensate tray

Place the condensate tray on shelf level 1 when using perforated containers. This collects any drops of liquid and allows these to be removed easily.

You can also use the condensate tray as a cooking container if necessary.

Temperature

Some functions have a pre-set recommended temperature. This temperature can be altered for a single programme, a specific programme stage or within the given range for a programme. You can alter the recommended temperature in 5 °C increments, or 1 °C increments in sous-vide cooking (see “Settings – Recommended temperatures”).

Cooking duration

You can set the cooking duration from 1 minute (00:01) to 10 hours (10:00). If the cooking duration exceeds 59 minutes you have to enter it in hours and minutes. Example: Cooking duration 80 minutes = 1:20.

During steam cooking, the cooking duration does not begin until the set temperature is reached.

Noises

You will hear a pumping sound when the appliance is switched on, during use and after switching it off. This is the sound of water being pumped through the system and is quite normal.

When the steam oven is in use, you will hear a fan noise.

Heating-up phase

While the steam oven is being heated up to the set temperature, the display will show Heating-up and the rising oven compartment temperature.

When cooking with steam, the duration of the heating-up phase will depend on the quantity and the temperature of the food. In general the heating-up phase will last for approx. 7 minutes. The duration will be longer if you are cooking refrigerated or frozen food. The heating-up phase may also last longer if cooking temperatures are low or if you are using the Sous-vide  cooking function.

Cooking phase

The cooking phase begins when the set temperature is reached. During the cooking phase, the duration remaining will be shown in the display.

Steam reduction

If you are cooking at a temperature of approx. 80 °C or above, the steam oven door will automatically open a little shortly before the end of the cooking time to allow some of the steam to escape. Steam reduction will appear on the display. The door closes again automatically.

Steam reduction can be switched off (see “Settings – Steam reduction”). With steam reduction switched off, a lot of steam will escape when the door is opened.

Oven interior lighting

For energy-saving reasons, the oven interior lighting has been set at the factory to go out after the programme has begun.

If you want it to stay on all the time the oven is on, you will need to alter the default setting (see “Settings – Lighting”).

If the door is left open at the end of a cooking programme, the oven interior lighting will switch off automatically after 5 minutes.

The lighting can be switched on for 15 seconds by touching the  button on the control panel.

Before using for the first time

Miele@home

Your steam oven is equipped with an integrated WiFi module.

In order to use it, you will need:

- a WiFi network,
- the Miele@mobile app, and
- a Miele user account, which can be created from the Miele@mobile app.

The Miele@mobile app will guide you as you connect your steam oven to your home WiFi network.

Once your steam oven is connected to your WiFi network, you can use the app for a number of actions, including the following:

- Getting information on the operating status of your steam oven
- Retrieving information on your steam oven's current cooking programmes
- Stopping cooking programmes that are in progress

Connecting your steam oven to your WiFi network will increase energy consumption, even when the steam oven is switched off.

Make sure that the signal of your WiFi network is sufficiently strong in the place where your steam oven is installed.

Availability of the WiFi connection

The WiFi connection shares a frequency range with other appliances (including microwave ovens and remote control toys). This can give rise to sporadic or even complete connection failures. Therefore, the availability of featured functions cannot be guaranteed.

Miele@home availability

The ability to use the Miele@mobile app depends on the availability of the Miele@home service in your country.

The Miele@home service is not available in every country.

For information about availability, please visit www.miele.com.

Miele@mobile App

The Miele@mobile App is available to download free of charge from the Apple App Store® or from the Google Play Store™.



Basic settings

The following settings must be made before starting up for the first time. You can change these settings again at a later time (see “Settings”).

 Risk of injury caused by hot surfaces.

The steam oven gets hot during operation.

For safety reasons, the steam oven may only be used when it has been fully installed.

The steam oven will switch on automatically when it is connected to the electricity supply.

Setting the language

- Select the desired language.
- Confirm with *OK*.

If you have selected the wrong language by mistake, proceed as described in “Settings –  Language”.

Setting the country

- Select the desired country.
- Confirm with *OK*.

Setting up Miele@home

Set up Miele@home will appear in the display.

- To set up Miele@home now, select *Continue* and confirm with *OK*.
- To set it up at a later date, select *Skip* and confirm with *OK*. See “Settings – Miele@home” for information on setting up at a later date.
- To set up Miele@home now, select the desired connection method.

You will then be guided by the display and the Miele@mobile app.

Setting the date

- Set the year, then the month, and finally the day.
- Confirm with *OK*.

Setting the time

- Set the time of day in hours and minutes.
- Confirm with *OK*.

Before using for the first time

Setting the water hardness level

Contact your local water supplier to find out the hardness of the water in your area.

More information can be found under “Settings – Water hardness”.

- Select your local water hardness on the appliance.
- Confirm with *OK*.

Completing the commissioning process

- Follow any further instructions in the display.

The oven is now ready for use.

Cleaning for the first time

- Remove any protective wrapping and stickers from the steam oven and accessories.

The appliance has undergone a function test in the factory. Residual water from this testing may have trickled back into the cabinet during transportation.

Cleaning the water container

- Remove the water container.
- Remove the spill guard.
- Wash the water container by hand.

Cleaning accessories/oven compartment

- Take all accessories out of the oven.
- Wash the accessories in a mild solution of washing-up liquid and hot water or in the dishwasher.

The interior of the steam oven has been treated at the factory with a conditioning agent.

- To remove this, clean the oven compartment with a clean sponge and a mild solution of washing-up liquid and hot water.

Before using for the first time

Set the correct boiling point for water

Before cooking food for the first time, you must adjust the steam oven to the boiling temperature of the water, which varies depending on the altitude of where the steam oven is located. This process also flushes out the components of the appliance that carry water.

This procedure **must** be carried out to ensure trouble-free functioning of your appliance.

Distilled water, carbonated water and other liquids may damage the steam oven.

Only use cold, fresh tap water (below 20 °C).





- Remove the water container and fill it up to the maximum marker.
- Push the water container into the appliance.
- Then run the steam oven for 15 minutes using the Steam cooking  function (100 °C). Proceed as described in “Operation”.

Setting the correct boiling point for water following a house move

If you move house, the appliance will need to be re-set for the new altitude if this differs from the old one by 300 m or more. To do this, descale the appliance (see “Cleaning and care – Descaling the steam oven”).

Settings

Settings overview

Menu option	Available settings
Language 	... deutsch english ... Country
Time	Show On* Off Night dimming Clock format 12 h 24 h* Set
Date	
Lighting	On "On" for 15 seconds* Off
Display	Brightness  QuickTouch On Off*
Volume	Buzzer tones Melodies*  Solo tone  Keypad tone  Welcome melody On* Off
Units	Weight g* lb/oz lb Temperature °C* °F
Keeping warm	On Off*
Steam reduction	On* Off
Recommended temperatures	
Water hardness	1 °dH ... 15 °dH* ... 70 °dH



* Factory default setting



Menu option	Available settings
Safety	Sensor lock On Off* System lock  On Off*
Miele@home	Activate Deactivate Connection status Set up again Reset Set up
Remote control	On* Off
Remote update	On* Off
Software version	
Showroom programme	Demo mode On Off*
Factory default	Appliance settings User programmes Recommended temps.

* Factory default setting

Settings

Opening the “Settings” menu

In the Further  | Settings  menu, you can personalise your steam oven by adapting the factory default settings to suit your requirements.

- Select Further .
- Select Settings .
- Select the desired setting.



You can check settings or change them.

Settings cannot be changed while a cooking programme is in progress.

Language

You can set the desired language and country.

After selecting and confirming your choice, the language you have selected will appear in the display.

Tip: If you have selected the wrong language by mistake, select the  sensor control. Follow the  symbol to get back to the Language  sub-menu.

Time

Show

Select how you want the time of day to show in the display when the steam oven is switched off:

- On
The time is always visible on the display.
If you also select the Display | Quick-Touch | On setting, all sensor controls react to touch straight away.
If you also select the Display | Quick-Touch | Off setting, the steam oven has to be switched on before it can be used.
- Off
To save energy, the display does not light up. The steam oven has to be switched on before it can be used.
- Night dimming
To save energy the time only shows in the display between 05:00 and 23:00. The display remains dark at all other times.

Clock format

The time of day can be displayed in the 24 or 12-hour format (24 h or 12 h).

Set

Set the hours and the minutes.



If there is a power cut, the current time of day will reappear once power has been restored. The time of day is saved for approx. 150 hours.

If the steam oven has been connected to a WiFi network and signed into the Miele@mobile app, the time will be synchronised based on the country setting in the Miele@mobile app.

Date

Set the date.



Lighting

- On
The oven interior lighting is switched on during the entire cooking period.
- "On" for 15 seconds
The oven interior lighting switches off 15 seconds after a cooking programme has begun. Press the  sensor control to switch the oven interior lighting on again for 15 seconds.
- Off
The oven interior lighting is switched off. Press the  sensor control to switch on the oven interior lighting for 15 seconds.

Display

Brightness

The display brightness is represented by a bar with seven segments.

- 
Maximum brightness
- 
Minimum brightness

QuickTouch

Select how the sensor controls should respond when the steam oven is switched off:

- On
If you have also selected the Time | Show | On or Night dimming setting, the sensor controls will also respond when the steam oven is switched off.
- Off
Independently of the Time | Show setting, the sensor controls only respond when the steam oven is switched on, as well as for a certain amount of time after switching it off.

Settings

Volume

Buzzer tones

If buzzers are switched on, a buzzer will sound when the set temperature is reached and at the end of a set time.

Melodies

At the end of a process, a melody will sound several times in intervals.

The volume of the melody is represented by a bar with seven segments.

– ■■■■■■■■
Maximum volume

– □□□□□□□
Melody is switched off

Solo tone

At the end of a process, a continuous tone will sound for a period of time.

The pitch of this continuous tone is represented by a segment bar.

– ■■■■■■■■■■■■■■■■■■■■
Maximum pitch

– □□□□□□□□□□□□□□
Minimum pitch

Keypad tone

The volume of the tone that sounds each time you touch a sensor control is represented by a bar with seven segments.

– ■■■■■■■■
Maximum volume

– □□□□□□□
Tone is switched off

Welcome melody

The melody that sounds when you touch the ① On/Off sensor control can be switched on or off.

Units

Weight

For automatic programmes, you can set the weight of food in grams (g), pounds/ounces (lb/oz) or pounds (lb).

Temperature

You can set the temperature in degrees Celsius (°C) or degrees Fahrenheit (°F).

Keeping warm

Using the Keeping warm function you can keep food warm after cooking. Food is kept warm at a pre-set temperature for a maximum of 15 minutes. You can cancel the keeping warm process by opening the door or touching the sensors.

Please note that delicate food, especially fish, can continue cooking whilst being kept warm.

- On
The Keeping warm function is switched on. When cooking with a temperature of approx. 80 °C or above, this function is active after approx. 5 minutes. The food is kept warm at a temperature of 70 °C.
- Off
The Keeping warm function is switched off.

Steam reduction

- On
If you are cooking at a temperature of approx. 80 °C or above, the steam oven door will automatically open a little shortly before the end of the cooking duration. The function stops excessive steam escaping when the door is opened. The door closes again automatically.
- Off
If steam reduction is switched off, the Keeping warm function is also automatically switched off. With steam reduction switched off, a lot of steam will escape when the door is opened.

Recommended temperatures

If you often cook with different temperatures, it makes sense to change the recommended temperatures.

After selecting this menu option, a list of functions will appear in the display.

- Select the desired function.

The recommended temperatures are displayed along with the available temperature range.

- Change the recommended temperatures.
- Confirm with *OK*.

Settings

Water hardness

The steam oven must be adjusted to the local water hardness level to ensure that it works correctly and to ensure that descaling is carried out at the correct interval. The harder the water is, the more frequently the steam oven needs to be descaled.

Contact your local water supplier to find out the hardness of the water in your area.

If you use bottled water, such as mineral water, make sure it is not carbonated. Adjust this setting depending on the calcium content. The calcium content is specified on the label of the bottle in mg/l Ca²⁺ or ppm (mg Ca²⁺/l).

You can set the hardness level between 1 °dH and 70 °dH. The hardness level is set to 15 °dH by default.

- Select your local water hardness on the appliance.
- Confirm with OK.

Water hardness		Calcium content mg/l Ca ²⁺ or ppm (mg Ca ²⁺ /l)	Setting
°dH	mmol/l		
1	0.2	7	1
2	0.4	14	2
3	0.5	21	3
4	0.7	29	4
5	0.9	36	5
6	1.1	43	6
7	1.3	50	7
8	1.4	57	8
9	1.6	64	9
10	1.9	71	10

Water hardness		Calcium content mg/l Ca ²⁺ or ppm (mg Ca ²⁺ /l)	Setting
°dH	mmol/l		
11	2.0	79	11
12	2.2	86	12
13	2.3	93	13
14	2.5	100	14
15	2.7	107	15
16	2.9	114	16
17	3.1	121	17
18	3.2	129	18
19	3.4	136	19
20	3.6	143	20
21	3.8	150	21
22	4.0	157	22
23	4.1	164	23
24	4.3	171	24
25	4.5	179	25
26	4.7	186	26
27	4.9	193	27
28	5.0	200	28
29	5.2	207	29
30	5.4	214	30
31	5.6	221	31
32	5.8	229	32
33	5.9	236	33
34	6.1	243	34
35	6.3	250	35
36	6.5	257	36
37–45	6.6–8.0	258–321	37–45
46–60	8.2–10.7	322–429	46–60
61–70	10.9–12.5	430–500	61–70

Safety

Sensor lock

The sensor lock prevents the cooking programme being switched off by mistake or settings being changed. Apart from the ① On/Off sensor control, the activated sensor lock prevents the sensor controls and fields in the display from working for a few seconds after a programme has been started.

- On
The sensor lock is active. Touch the *OK* sensor control for at least 6 seconds to deactivate the sensor lock for a short period of time.
- Off
The sensor lock is deactivated. All sensor controls react again to touch as normal.

System lock

The system lock prevents the steam oven being switched on by mistake.

The minute minder and the MobileStart function can still be used when the system lock is active.

The system lock will remain activated even after a mains outage.

- On
The system lock has been activated. Before you can use the steam oven, touch the *OK* sensor control for at least 6 seconds.
- Off
The system lock is deactivated. You can use the steam oven as normal.

Settings

Miele@home

The steam oven is a Miele@home-compatible appliance. Your steam oven is fitted ex-works with a WiFi communication module and is suitable for wireless communication.

There are a number of ways of connecting your steam oven to your WiFi network. We recommend connecting your steam oven to your WiFi network using the Miele@mobile App or via WPS.

After installing the Miele@mobile App on a mobile device, you can do the following:

- Operate your appliance remotely
 - Call up information on the operating status of your appliance
 - Call up information on the programme sequence of your appliance
 - Set up a Miele@home network with other Wi-Fi enabled Miele appliances
- Activate
This setting is only visible if Miele@home is deactivated. The WiFi function is reactivated.
 - Deactivate
This setting is only visible if Miele@home is activated. Miele@home remains set up, the WiFi function is switched off.
 - Connection status
This setting is only visible if Miele@home is activated. The display shows information such as the WiFi reception quality, network name and IP address.
 - Set up again
This setting is only visible if a WiFi network has already been set up. Reset the network settings and immediately set up a new network connection.
 - Reset
This setting is only visible if a WiFi network has already been set up. The WiFi function is deactivated and the WiFi connection will be reset to the factory default setting. You must set up a new WiFi connection to be able to use Miele@home.
 - Set up
This setting is only visible if there is no existing WiFi connection. You must set up a new WiFi connection to be able to use Miele@home.

Remote control

If you have installed the Miele@mobile app on your mobile device, have access to the Miele@home system and have activated the remote control function (On), you can use the MobileStart function to retrieve information on steam oven cooking programmes that are in progress or to end a programme in progress.

Activating MobileStart

- Select the  sensor control to activate MobileStart.

The  sensor control lights up. You can operate your steam oven remotely with the Miele@mobile app.

Directly operating the steam oven via the touch display takes priority over operating it via the remote control function on the app.

You can use MobileStart as long as the  sensor control is lit up.

Remote update

The Remote update menu option is only displayed and can only be selected if the requirements for using Miele@home have been met (see “Before using for the first time – Miele@home”).

The RemoteUpdate function is used for updating the software in your steam oven. If an update is available for your steam oven, it will automatically download it. Updates will not be installed automatically. They must be initiated manually.

If you do not install an update, you can continue to use your steam oven as usual. However, Miele recommends installing updates.

Activating/deactivating

The RemoteUpdate function is activated as standard. Available updates will be downloaded automatically but will only be installed if you initiate installation manually.

Deactivate RemoteUpdate if you do not want any updates to be downloaded automatically.

Settings

Running RemoteUpdate

Information about the content and scope of an update will be provided in the Miele@mobile app.

A message will appear in your steam oven display if a software update is available.

You can install the update immediately or postpone this until later. When the steam oven is switched on again, you will be reminded about the update.

Deactivate RemoteUpdate if you do not want to install the update.

The update may take several minutes.

Please note the following information about the RemoteUpdate function:

- You will only receive a message when an update is available.
- Once an update has been installed, it cannot be undone.
- Do not switch the steam oven off during the update. Otherwise, the update will be aborted and will not be installed.
- Some software updates can only be carried out by the Miele Customer Service Department.

Software version

The software version is intended for the Miele Customer Service Department. You do not need this information for domestic use.

Showroom programme

This function enables the steam oven to be demonstrated in showrooms without heating up. This setting is not needed for domestic use.

Demo mode

If you have demo mode activated, Demo mode switched on. The appliance will not heat up **will appear when you switch the steam oven on.**

- On
Touch the OK sensor control for at least 4 seconds to activate demo mode.
- Off
Touch the OK sensor control for at least 4 seconds to deactivate demo mode. You can then use the steam oven as normal.

Factory default

- Appliance settings
Any settings that have been altered will be reset to the factory default settings.
- User programmes
All User programmes will be deleted.
- Recommended temps.
Any recommended temperatures that have been changed will be reset to the factory default settings.

Using the Minute minder function

The  minute minder can be used to time other activities in the kitchen, e.g. boiling eggs.

The minute minder can also be used at the same time as a cooking programme for which the cooking duration start and finish times have been set (e.g. as a reminder to stir the food or add seasoning, etc.).

- The maximum minute minder time that can be set is 59 minutes and 59 seconds.

Setting the minute minder

If you have selected the Display | Quick-Touch | Off setting, you will need to switch the steam oven on before setting the minute minder. The minute minder can then be seen counting down in the display when the steam oven is switched off.

Example: you want to boil some eggs and set a minute minder duration of 6 minutes and 20 seconds.

- Select the  sensor control.
- Select Minute minder if a cooking programme is in progress at the same time.

The prompt Set 00:00 min appears.

- Using the navigation area, set 06:20.
- Confirm with OK.

The minute minder duration is now saved.

When the steam oven is switched off the minute minder duration counts down in the display and  appears instead of the time of day.

If you are cooking at the same time,  and the minute minder duration will appear at the bottom of the display.

If you are in a menu, the minute minder counts down in the background.

At the end of the minute minder duration,  will flash, the time will start counting up and a tone will sound.

- Select the  sensor control.
- If required, confirm with OK.

The buzzer will stop and the symbols in the display will go out.

Changing the minute minder duration

- Select the  sensor control.
- Select Minute minder if a cooking programme is in progress at the same time.
- Select Change.
- Confirm with OK.

The minute minder duration selected appears.

- Change the duration set for the minute minder.
- Confirm with OK.

The altered minute minder duration is now saved.









Minute minder

Deleting the minute minder duration

- Select the 🕒 sensor control.
- Select Minute minder if a cooking programme is in progress at the same time.
- Select Delete.
- Confirm with *OK*.

The minute minder duration is now deleted.

Main and sub-menus

Menu	Recommended value	Range
Oven functions		
Steam cooking 	100 °C	40–100 °C
Sous-vide 	65 °C	45–90 °C
Reheat 	100 °C	80–100 °C
User programmes 		
Defrost 	60 °C	50–60 °C
Descalc 		
Automatic programmes 		
Further 		
Blanching	–	–
Bottling	90 °C	80–100 °C
Disinfect items	–	–
Prove dough	–	–
Eco Steam cooking	100 °C	40–100 °C
Settings 		

Operation

- Switch the steam oven on.

The main menu will appear.

Distilled or carbonated water or other liquids could damage the steam oven.

Only use cold, fresh tap water (below 20 °C).

- Fill the water container and push it into the appliance.
- Place the condensate tray on shelf level 1 when using perforated containers.
- Place the food in the oven.
- Select the desired function.

The function and the recommended temperature will appear.

- Change the recommended temperature if necessary.

The recommended temperature will be accepted within a few seconds. You can change the temperature subsequently via the ↵ sensor.

- Confirm with *OK*.

The required and the actual temperature will appear and the heating-up phase will begin.

You will see the temperature increasing. A buzzer will sound when the set temperature is reached for the first time.

- After cooking, select the sensor for the selected function to end the cooking programme.

 Risk of injury caused by hot steam.

A great deal of hot steam can escape when the door is opened. The steam can cause burns.

Step back and wait until the hot steam has dissipated.

- Take the food out of the oven.
- Switch the steam oven off.

Cleaning the steam oven

- If necessary, remove the condensate tray from the oven compartment and empty it.

 Risk of injury caused by hot water.

At the end of a cooking programme, hot water left in the steam generator is pumped back into the water container.

Take care not to tip the water container when taking it out of the appliance.

- Remove the water container.
- Remove the spill guard and empty the water container.
- After each use, clean and dry the whole appliance as described in “Cleaning and care”.

Make sure the spill guard engages correctly when installing it.

- Leave the appliance door open until the oven compartment is completely dry.

Refilling the water

If water needs replenishing during the programme, a tone will sound and the display will prompt you to refill the container with fresh water.

- Take out the water container and replenish the water.
- Push the water container into the appliance.

The cooking programme is resumed.

Changing values and settings for a cooking programme

Depending on the function, as soon as a cooking programme is in progress, you can use the  sensor control to change the values or settings for this programme.

- Select the  sensor control.

Depending on the function, the following settings appear:

- Temperature
- Duration



Changing values and settings

- Select the desired value or setting and confirm with *OK*.
- Change the value or setting and confirm with *OK*.

The cooking programme will restart with the new values and settings.

Operation

Changing the temperature

You can permanently reset the recommended temperature to suit your cooking preferences by selecting Further  | Settings  | Recommended temperatures.

- Select the  sensor control.
- Select Temperature and confirm with *OK*.
- Change the desired temperature via the navigation area.
- Confirm with *OK*.



The cooking programme will restart with the new desired temperature.

Setting cooking durations

Cooking results can be impaired if there is a long delay between the food being placed in the oven and the start of cooking. Fresh food can change colour and even spoil. Select as short as possible a time until the cooking programme starts.

You have placed the food in the oven compartment, selected a function and the required settings such as the temperature.

By entering Duration, Finish at or Start at via the  sensor control, you can automatically switch the cooking programme off or on and off.

- Duration
Enter the desired cooking duration for the food. The heating will switch off automatically once this duration has elapsed. The maximum cooking duration that can be set depends on the function that you have selected.
 - Finish at
Specify when you want the cooking programme to end. The oven heating will switch off automatically at the time you have set.
 - Start at
This function will only appear in the menu if you have set a Duration or Finish at time. With Start at, you have to specify when you want the cooking programme to start. The oven heating will switch on automatically at the time you have set.
- Select the  sensor control.
 - Set the desired times.
 - Confirm with *OK*.
 - Touch the  sensor control to return to the menu of the selected function.
- Tip:** You can also adjust the cooking duration directly via the navigation area.

The cooking duration does not begin until the set temperature is reached.

If you are cooking at a temperature of approx. 80 °C or above, Steam reduction will appear in the display shortly before the end of the cooking duration and the door will automatically open a little.

- Wait until Steam reduction goes out in the display before opening the door and removing the food from the oven.

A new cooking programme can only be started if the automatic door release is retracted into its original position. Do not push it in manually as this could damage it.

Operation

Changing the set cooking durations

- Select the ⌚ sensor.
- Select the desired time.
- Confirm with *OK*.
- Select *Change*, if required.
- Change the set time.
- Confirm with *OK*.
- Touch the ↶ sensor to return to the menu of the selected function.

These settings will be deleted in the event of a power failure.

Tip: You can also adjust the cooking duration directly via the navigation area.

Deleting the set cooking durations

You can delete the Duration in the Steam cooking , Sous-vide  and Eco Steam cooking functions.

- Select the ⌚ sensor.
- Select the desired time.
- Confirm with *OK*.
- Select *Delete*.
- Confirm with *OK*.
- Touch the ↶ sensor to return to the menu of the selected function.

If you delete Duration, the set times for Finish at and Start at are also deleted.

If you delete Finish at or Start at, the cooking programme will start using the cooking duration set.

Tip: You can also delete the cooking duration directly via the navigation area.

Interrupting a cooking programme

A cooking programme is interrupted as soon as the door is opened. The oven heating switches off. Set cooking durations will be saved.

 Risk of injury caused by hot steam.

A great deal of hot steam can escape when the door is opened. The steam can cause burns.

Step back and wait until the hot steam has dissipated.

 Risk of injury caused by hot surfaces and food.

The steam oven gets hot during operation. You could burn yourself on the oven compartment, side runners, accessories or the food itself.

Use oven gloves when placing food in the oven compartment or removing it and when working in the hot oven compartment.

When placing cooking containers into the oven or removing them, make sure that the hot food does not spill.

The cooking programme will resume when the door is closed.

When the door is closed, the pressure has to equalise, which can cause a whistling sound.

The steam oven will heat up again and the display will show the temperature in the oven compartment as it rises. Once the set temperature has been reached, the display will show the time left as it counts down.

The cooking programme will finish early if the door is opened in the last minute of cooking.

Operation

Cancelling a cooking programme

You can cancel a cooking programme using the function sensor control that lights up orange or using the ↵ sensor control.

The oven compartment heating and lighting will then switch off. Any cooking durations set will be deleted.

Touch the function sensor control to return to the main menu.

Cancelling a cooking programme without a set cooking duration

- Touch the sensor control for the selected function.

The main menu will appear.

- **Or:** select the ↵ sensor control.
- Select *Cancel process*.
- Confirm with *OK*.

Cancelling a cooking programme with a set cooking duration

- Touch the sensor control for the selected function.

Cancel process? appears in the display.

- Select *Yes*.
- Confirm with *OK*.
- **Or:** select the ↵ sensor control.
- Select *Cancel process*.
- Confirm with *OK*.
- Select *Yes*.
- Confirm with *OK*.

This section contains general information. You will find more detailed information about particular foods and how to cook them in the other sections.

The advantages of cooking with steam

Almost all vitamins and minerals are retained as the food is not immersed in water.

Cooking with steam also retains the true taste of the food better than conventional cooking. We therefore recommend seasoning the food after it has been cooked. Food also retains its fresh, original colour.

Suitable containers

Cooking containers

This steam oven is supplied with stainless steel cooking containers. Other containers, in a variety of sizes, both perforated and solid, are available as optional extras (see “Optional accessories”). This enables you to choose the most suitable container for the food you are cooking.

It is best to use perforated containers for steam cooking. The steam can reach the food from all sides and the food is cooked evenly.

Your own containers

You can also use your own containers. However, please note the following:

- Containers must be heat-resistant to 100 °C and able to withstand steam. With plastic containers please check with the manufacturer that they are suitable for use in a steam oven.
- Thick-sided containers such as porcelain, ceramic, or stoneware are not very suitable for using with steam. Due to their thick sides, they do not conduct heat well and as a result cooking durations will be considerably longer than those given in the tables.
- Place the cooking container on the rack or in a suitable container, and not on the oven floor.
- Ensure that there is a gap between the upper rim of the container and the top of the cooking compartment to allow sufficient steam into the container.

Condensate tray

Place the condensate tray on shelf level 1 when using perforated containers. This collects any drops of liquid and allows these to be removed easily.

You can also use the condensate tray as a cooking container if necessary.

General notes

Shelf level

You can select any shelf level. You can also cook on several levels at the same time. This will not alter the cooking duration.

When using more than one deep container at the same time for steam cooking, it is best to offset them on their runners and to leave at least one level free in between them.

Always insert cooking containers and the rack between the rails of the shelf level supports so that they cannot tip.

Frozen food

The heating up phase for frozen food is longer than for fresh food. The greater the quantity of frozen food, the longer the heating up phase.

Temperature

During steam cooking, the temperature does not exceed 100 °C. Almost all foods can be cooked at this temperature. Some types of food, such as berries, need to be cooked at lower temperatures to prevent them from bursting. See the relevant sections in these operating instructions for more details.

Cooking duration

During steam cooking, the cooking duration does not begin until the set temperature is reached.

In general, the cooking durations for cooking with steam are the same as for cooking food in a saucepan. More information about any factors which may affect the cooking duration is given in the relevant sections.

The quantity of food does not affect the cooking duration. 1 kg of potatoes will take the same time to cook as 500 g.

Cooking with liquid

When cooking with liquid only fill the cooking container $\frac{2}{3}$ full to prevent the liquid spilling when the cooking container is removed from the oven.

Your own recipes

Food which is cooked in a pot or a pan can also be cooked in the steam oven. The cooking durations in the steam oven will be the same. Please note that food will not be brown or crisp when cooking with steam.

Eco Steam cooking

You can use the Eco Steam cooking function to save energy during steam cooking. This function is suitable mainly for cooking fish and vegetables.

We recommend following the cooking durations and temperatures from the tables specified in “Steam cooking”. You can cook for longer if necessary.

When cooking starchy foods such as potatoes, rice and pasta, the best function to use is Steam cooking .

Settings

Further  | Eco Steam cooking

Notes on the cooking tables

Follow the instructions on cooking durations, temperatures and cooking notes.

Selecting the cooking duration

The cooking durations given are guidelines only.

- We recommend selecting the shorter duration initially. You can cook for longer if necessary.

Steam cooking

Vegetables

Fresh

Prepare fresh vegetables in the usual way, i.e. wash, clean and cut them up.

Frozen food

Frozen vegetables do not need to be defrosted beforehand, unless they have been frozen together in a block.

Frozen and fresh vegetables which take the same length of time to cook can be cooked together.

If vegetables have frozen together in clumps, break these up before cooking with steam. Follow the manufacturer's instructions on the packaging regarding cooking duration.

Cooking containers

Food such as peas or asparagus spears, which have little or no space between them, will take longer to cook because the steam has less space to work in. For an even result, it is best to use a shallow container for these types of food, and only fill it about 3-5 cm deep. When cooking large quantities divide the food between 2 or 3 shallow containers rather than using one deep one.

Different types of vegetables which take the same length of time to cook can be cooked together.

Use solid containers for vegetables which are cooked in liquid.

Shelf level

To avoid any colour transfer when cooking vegetables with a distinctive colour (e.g. beetroot) in a perforated container, do not place other food underneath the perforated container.

Cooking duration

The cooking duration depends on the size of the food and how well cooked you want it, just as it does with conventional cooking methods. Example:

Waxy potatoes, cut into quarters:
approx. 17 minutes

Waxy potatoes, cut in half:
approx. 20 minutes

Settings

Automatic programmes  | Vegetables
| ... |

or

Steam cooking 

Temperature: 100 °C

Cooking duration: see table

Steam cooking

Vegetables	 [min]
Artichokes	32–38
Cauliflower, whole	27–28
Cauliflower, florets	8
Beans, green	10–12
Broccoli, florets	3–4
Chantenay carrots, whole	7–8
Chantenay carrots, halved	6–7
Chantenay carrots, chopped	4
Chicory, halved	4–5
Chinese cabbage, chopped	3
Peas	3
Fennel, halved	10–12
Fennel, sliced	4–5
Kale, chopped	23–26
Waxy potatoes, peeled whole halved quartered	27–29 21–22 16–18
Mainly waxy potatoes, peeled whole halved quartered	25–27 19–21 17–18
Floury potatoes, peeled whole halved quartered	26–28 19–20 15–16
Kohlrabi, cut into batons	6–7
Pumpkin, diced	2–4
Corn on the cob	30–35
Chard, chopped	2–3

Steam cooking

Vegetables	 [min]
Peppers, diced or sliced	2
New potatoes, firm	30–32
Mushrooms	2
Leeks, sliced	4–5
Leeks, halved lengthways	6
Romanesco, whole	22–25
Romanesco, florets	5–7
Brussels sprouts	10–12
Beetroot, whole	53–57
Red cabbage, chopped	23–26
Black salsify, whole	9–10
Celeriac, cut into batons	6–7
Asparagus, green	7
Asparagus, white, whole	9–10
Carrots, chopped	6
Spinach	1–2
Spring cabbage, chopped	10–11
Celery, chopped	4–5
Swede, chopped	6–7
White cabbage, chopped	12
Savoy cabbage, chopped	10–11
Courgettes, sliced	2–3
Sugar snap peas	5–7

 Cooking duration

Fish

Fresh

Prepare fresh fish in the usual way, i.e. clean, gut and fillet.

Frozen food

Fish does not need to be fully defrosted before cooking. Defrost so that the surface is sufficiently thawed to take herbs and seasoning. Depending on the thickness of the fish, 2 - 5 minutes should be enough.

Preparation

Add some lemon or lime juice to fish before cooking. The citric acid helps the flesh stay firm.

It is not necessary to season fish with salt when cooking with steam as this method retains the minerals which give the fish its unique flavour.

Cooking containers

If using a perforated container, grease it first.

Shelf level

When cooking fish in a perforated container at the same time as cooking other types of food in other containers, place the container with the fish directly above the glass or collecting tray (depending on the model) to catch any liquid and so avoid any transfer of flavours to other food.

Temperature

85 °C – 90 °C

For gently cooking delicate types of fish, such as sole.

100 °C

For cooking firmer types of fish, e.g. cod and salmon.

Also for cooking fish in sauce or stock.

Duration

The cooking duration depends on the thickness and the texture of the fish, and not on the weight. The thicker the fish, the longer the cooking duration. A 3 cm thick piece of fish weighing 500 g will take longer to cook than a 2 cm thick piece of fish weighing 500 g.

The longer fish cooks, the firmer its flesh will become. Use the cooking durations given in the chart. If you find that the fish is not cooked sufficiently only cook it for a few minutes more.

When cooking fish in sauce or stock, we recommend that you increase the cooking duration quoted by a few minutes.

Steam cooking

Tips

- Adding herbs and spices, such as dill, will help bring out the full flavour of the fish.
- Cook large fish in swimming position. To help maintain the shape of the fish, place a small cup or similar upside down in the cooking container, and arrange the fish belly-side down over the cup.
- You can use any fish scraps, e.g. fish heads, bones, tails etc to make a **fish stock**. Place the fish scraps together with some mixed vegetables in a solid cooking container and add cold water. Cook at 100 °C for 60 to 90 minutes. The longer the cooking duration, the stronger the stock.
- Preparing fish **au bleu** is a method involving cooking the fish in water with vinegar, at different proportions depending on the recipe. It is important not to damage the skin of the fish. This method is suitable for cooking carp, trout, tench, eel and salmon.

Settings

Automatic programmes Auto | Fish | ... |

or

Steam cooking 

Temperature: see table

Cooking duration: see table

Steam cooking

Fish	🌡️ [°C]	🕒 [min]
Eel	100	5–7
Perch fillet	100	8–10
Seabream fillet	85	3
Trout, 250 g	90	10–13
Halibut fillet	85	4–6
Cod fillet	100	6
Carp, 1.5 kg	100	18–25
Salmon fillet	100	6–8
Salmon steak	100	8–10
Salmon trout	90	14–17
Basa fillet	85	3
Rosefish fillet	100	6–8
Haddock fillet	100	4–6
Plaice fillet	85	4–5
Monkfish fillet	85	8–10
Sole fillet	85	3
Turbot fillet	85	5–8
Tuna fillet	85	5–10
Pike perch fillet	85	4

🌡️ Temperature 🕒 Duration

Steam cooking

Meat

Fresh

Prepare the meat in the usual way.

Frozen food

Meat should be thoroughly defrosted before cooking in the steam oven (see “Special applications” – “Defrost”).

Preparation

For meat which needs to be seared before being cooked, e.g. for a stew, sear the meat in a pan on the hob first.

Duration

The cooking duration depends on the thickness and the texture of the meat, and not on the weight. The thicker the piece of meat, the longer the cooking duration. A piece of meat weighing 500 g which is 10 cm thick will take longer to cook than a piece of meat weighing 500 g which is 5 cm thick.

Tips

- To retain the **flavourings**, use a perforated cooking container. Place an unperforated cooking container underneath in order to collect the concentrate. You can use the concentrate to enhance your sauces or freeze it for later use.
- Boiling fowl, back or top rib and meat bones can be used to make **stock**. Place the meat together with the bones and some mixed vegetables in a cooking container and add cold water. The longer the cooking duration, the stronger the stock.

Settings

Automatic programmes  | Meat | ... |

or

Steam cooking 

Temperature: 100 °C

Cooking duration: see table

Steam cooking

Meat	🕒 [min]
Leg steak, covered with water	110–120
Pork knuckle	135–140
Chicken breast	8–10
Hock	105–115
Top rib, covered with water	110–120
Veal strips	3–4
Gammon slices	6–8
Lamb stew	12–16
Poularde	60–70
Turkey roulades	12–15
Turkey escalopes	4–6
Short rib, covered with water	130–140
Beef goulash	105–115
Whole chicken, covered with water	80–90
Topside	110–120

🕒 Cooking duration

Steam cooking

Rice

Rice swells when cooked and needs to be cooked in liquid. The proportion of rice to liquid will vary depending on the type of rice.

The rice absorbs all the liquid during the cooking process and so none of the nutrients are lost.

Settings

Automatic programmes  | Rice | ... |

or

Steam cooking 

Temperature: 100 °C

Cooking duration: see table

	Ratio Rice : Liquid	 [min]
Basmati rice	1 : 1.5	15
Parboiled rice	1 : 1.5	23–25
Round grain rice		
Pudding rice	1 : 2.5	30
Risotto rice	1 : 2.5	18–19
Brown rice	1 : 1.5	26–29
Wild rice	1 : 1.5	26–29

 Duration

Grain

Grain swells during cooking and needs to be cooked in liquid. The proportion of grain to liquid depends on the type of grain.

Grain can be cooked whole or cracked.

Settings

Automatic programmes  | Grain | ... |

or

Steam cooking 

Temperature: 100 °C

Cooking duration: see table

	Ratio Grain : Liquid	 [min]
Amaranth	1 : 1.5	15–17
Bulgur	1 : 1.5	9
Green spelt, whole	1 : 1	18–20
Green spelt, cracked	1 : 1	7
Oats, whole	1 : 1	18
Oats, cracked	1 : 1	7
Millet	1 : 1.5	10
Polenta	1 : 3	10
Quinoa	1 : 1.5	15
Rye, whole	1 : 1	35
Rye, cracked	1 : 1	10
Wheat, whole	1 : 1	30
Wheat, cracked	1 : 1	8

 Duration

Steam cooking

Pasta

Dry pasta

Dry pasta swells when it is cooked and needs to be cooked in liquid. The liquid must cover the pasta. Using hot liquid gives better results.

Increase the cooking time stated by the manufacturer by approx. $\frac{1}{3}$.

Fresh food

Fresh pasta, such as the kind you can buy from the supermarket chilled counter, does not need to absorb water. Cook fresh pasta in a greased perforated container.

Separate any pieces of pasta which have stuck together and spread them out in the cooking container.

Settings

Automatic programmes  | Pasta | ... |

or

Steam cooking 

Temperature: 100 °C

Cooking duration: see table

Fresh	 [min]
Gnocchi	2
Knöpfli	1
Ravioli	2
Spätzle	1
Tortellini	2
Dry pasta, covered with water	
Tagliatelli	14
Vermicelli	8

 Duration

Dumplings

Ready made boil-in-the-bag dumplings need to be well covered with water as otherwise they can fall apart. This is because even though they have been soaked in water beforehand they will not absorb enough moisture.

Cook fresh dumplings in a greased, perforated container.

Settings

Automatic programmes  | Pasta | ... |

or

Steam cooking 

Temperature: 100 °C

Cooking duration: see table

	 [min]
Sweet dumplings	30
Yeast dumplings	20
Boil-in-the-bag potato dumplings	20
Boil-in-the-bag bread dumplings	18–20

 Duration

Steam cooking

Dried pulses

Soak pulses for at least 10 hours in cold water before cooking. Soaking makes the pulses more digestible and shortens the cooking duration required. Soaked pulses must be covered with liquid during cooking.

Lentils do not need to be soaked before cooking.

With unsoaked pulses a certain ratio of pulses to liquid is required depending on variety.

Settings

Automatic programmes  | Pulses | ... |

or

Steam cooking 

Temperature: 100 °C

Cooking duration: see table

Soaked	
	 [min]
Beans	
Kidney beans	55–65
Adzuki beans	20–25
Black beans	55–60
Pinto beans	55–65
Haricot beans	34–36
Peas	
Yellow split peas	40–50
Green split peas	27

 Duration

Steam cooking

Unsoaked		
	Ratio Pulses : Liquid	🕒 [min]
Beans		
Kidney beans	1 : 3	130–140
Adzuki beans	1 : 3	95–105
Black beans	1 : 3	100–120
Pinto beans	1 : 3	115–135
Haricot beans	1 : 3	80–90
Lentils		
Brown lentils	1 : 2	13–14
Red lentils	1 : 2	7
Peas		
Yellow split peas	1 : 3	110–130
Green split peas	1 : 3	60–70

🕒 Duration

Steam cooking

Hen's eggs

Use a perforated container to boil eggs in the steam oven.

The eggs do not need to be pierced before cooking as they are gradually warmed during the heating up phase and so do not burst when they are cooked with steam.

When using a solid container for making egg dishes such as scrambled eggs, remember to grease it first.

Settings

Automatic programmes  | Hen's eggs | ... |

or

Steam cooking 

Temperature: 100 °C

Cooking duration: see table

	 [min]
Small soft medium hard	 3 5 9
Medium soft medium hard	 4 6 10
Large soft medium hard	 5 6–7 12
Extra large soft medium hard	 6 8 13

 Duration

Fruit

Cook fruit in a solid container so that none of the juice is lost. If you wish to cook fruit in a perforated container, place a solid container directly underneath it to collect the juice.

Tip: You can use the juice which has collected in the solid container to make a glaze for a fruit flan.

Settings

Automatic programmes  | Fruit | ... |

or

Steam cooking 

Temperature: 100 °C

Cooking duration: see table

	 [min]
Apple chunks	1–3
Pear chunks	1–3
Cherries	2–4
Mirabelle plums	1–2
Nectarine/peach chunks	1–2
Plums	1–3
Quinces, diced	6–8
Rhubarb chunks	1–2
Gooseberries	2–3

 Cooking duration

Sausages

Settings

Automatic programmes  | Sausages

| ... |

or

Steam cooking 

Temperature: 90 °C

Cooking duration: see table

Sausages	 [min]
Frankfurters	6–8
Bologna sausages	6–8
Veal sausages	6–8

 Duration

Steam cooking

Shellfish

Preparation

Defrost frozen shellfish before cooking with steam.

Peel, remove and discard the intestines, and then wash the shellfish.

Cooking containers

If using a perforated container, grease it first.

Duration

The longer shellfish are cooked, the tougher they become. Use the cooking durations given in the chart.

When cooking shellfish in sauce or stock, we recommend that you increase the cooking duration quoted by a few minutes.

Settings



Automatic programmes  | Shellfish | ... |

or

Steam cooking 

Temperature: see table

Cooking duration: see table

	 [°C]	 [min]
Crevettes	90	3
Prawns	90	3
King prawns	90	4
Small shrimps	90	3
Lobster	95	10–15
Large shrimps	90	3

 Temperature  Duration

Mussels

Fresh food

 Danger of food poisoning from spoiled mussels.
Spoiled mussels can cause food poisoning.
Only cook mussels which are closed.
Do not eat mussels which have not opened after being cooked.

Steep fresh mussels in water for a few hours before cooking to rinse out any sand. Then scrub the mussels thoroughly to clean them.

Frozen food

Defrost frozen mussels before cooking.

Duration

The longer mussels are cooked, the tougher they become. Use the cooking durations given in the chart.

Settings



Automatic programmes  | Mussels and clams | ... |

or

Steam cooking 

Temperature: see table

Cooking duration: see table

	 [°C]	 [min]
Barnacles	100	2
Cockles	100	2
Mussels	90	12
Scallops	90	5
Razor clams	100	2–4
Venus clams	90	4

 Temperature  Duration

Steam cooking

Menu cooking (cooking whole meals)

Before cooking meals with the manual menu cooking function, switch off steam reduction (see “Settings – Steam reduction”).

When cooking a menu, you can combine different foods with different cooking durations, e.g. fish fillet with rice and broccoli.

The food is placed in the steam oven compartment at different times so that each item is ready at the same time.

Shelf level

Place foods that produce a lot of liquids (e.g. fish) or have a distinctive colour (e.g. beetroot) directly above the glass tray or condensate tray (depending on the model). This avoids any transfer of flavour or colour to other food and prevents liquid dripping onto food below it.

Temperature

Whole meals should be cooked at a temperature of 100 °C as this is the temperature required to cook the majority of foods.

Do not cook a whole meal at the lowest temperature when different temperatures are required for different types of food, e.g. 85 °C for seabream and 100 °C for potatoes.

If the recommended cooking temperature for the food is 85 °C for example, try cooking it at 100 °C and testing the result. Some delicate types of fish with a soft structure, e.g. sole and plaice will become very firm when cooked at 100 °C.

Duration

If you are increasing the recommended temperature, shorten the cooking duration by approx. $\frac{1}{3}$.

Example

Food cooking durations

(see cooking tables in “Steam cooking”)

Parboiled rice	24 minutes
Rosefish fillet	6 minutes
Broccoli	4 minutes

Calculation of set cooking durations:

24 minutes minus
6 minutes = 18 minutes (1st cooking duration: rice)

6 minutes minus 4 minutes = 2 minutes
(2nd cooking duration: rosefish fillet)

Remaining time = 4 minutes (3rd cooking duration: broccoli)

Cooking duration	24 min. – rice		
		6 min. – fish fillet	
			4 min. – broccoli
Settings	18 min.	2 min.	4 min.

Cooking a whole menu

- Place the rice in the oven compartment first.
- Set the 1st cooking duration: 18 minutes.
- After the 18 minutes, place the fish into the appliance.
- Set the 2nd cooking duration: 2 minutes.
- After the 2 minutes, place the broccoli into the appliance.
- Set the 3rd cooking duration: 4 minutes.

Sous-vide (vacuum) cooking

With this gentle cooking method, food is cooked slowly and at a low, constant temperature in vacuum packaging.

With vacuum cooking, no moisture evaporates during cooking and all nutrients and flavours are retained.

The cooking result has an intensive taste and food is cooked evenly.

Use only fresh food which is in a good condition.

Ensure hygienic conditions and that food has not been out of the refrigerator too long, e.g. during transportation.

Use only heat-stable, boiling-resistant vacuum sealing bags.

Do not cook food in the sales packaging, such as vacuum-packed frozen food as it is possible that the packaging used is not suitable for vacuum cooking.

Do not use the vacuum sealing bag more than once.

Vacuum-seal the food in a chamber system vacuum sealer only.

Sous-vide (vacuum) cooking

Important usage notes

For best cooking results, follow the instructions below:

- Use herbs and spices more sparingly than with conventional methods because the impact on the taste of the food will be stronger.
You can also cook the food unseasoned and add seasoning after cooking.
 - The cooking duration is reduced when salt, sugar and liquids are added.
 - The food becomes firmer if acidic ingredients such as lemon or vinegar are added.
 - Do not use alcohol or garlic as this can produce unpleasant flavours.
 - Only use vacuum sealing bags that match the size of the food. If the vacuum sealing bag is too big, too much air can remain inside.
 - If you want to cook several items of food in one vacuum sealing bag, put them side-by-side in the bag.
 - If you want to cook food in several vacuum sealing bags at once, put the bags side-by-side on the rack.
 - The cooking durations depend on the thickness of the food.
 - With higher temperatures and/or longer cooking durations, the appliance may run low on water. Check the display from time to time.
- Keep the door closed during the cooking programme. Opening the door will prolong the cooking programme and can change the cooking result.
 - Cooking at a lower temperature and for a longer duration can result in increased residual water in the cooking compartment. This does not affect the cooking results.
 - Temperatures and cooking durations from sous-vide recipes cannot always be emulated exactly. Alter the settings to achieve the degree of cooking you want.

Sous-vide (vacuum) cooking

Tips

– In order to reduce cooking times, you can vacuum-seal food items 1–2 days before the cooking programme. Store the vacuum-sealed food in the refrigerator at no more than 5 °C. In order to preserve quality and flavour, the food should be cooked no later than 2 days afterwards.

– Freeze liquids such as marinades before vacuum-sealing to prevent them from escaping from the bag.

– Fold the edges of the vacuum sealing bag outwards for filling. This will give you clean, perfect seams.

– If you do not want to eat the food straight after cooking, put it in iced water immediately and allow it to cool down completely. After this, store the food at temperatures no greater than 5 °C.

This way, you can retain the food's quality and flavour while keeping it fresh for longer.

Exception: Poultry must be eaten straight after the cooking programme.

– After cooking, cut the vacuum sealing bag on all sides for easier access to the food.

– Briefly fry meat and firm types of fish (such as salmon) before serving for a roasted aroma.

– Use the stock or marinade of vegetables, fish or meat to make a sauce.

– Serve the food on pre-warmed plates.

Sous-vide (vacuum) cooking

Using the Sous-vide function

- Rinse the food with cold water and dry it.
- Place the food in a vacuum sealing bag and add spices or liquid if desired.
- Vacuum-seal the food in a chamber system vacuum sealer.
- Place the condensate tray on shelf level 1.
- For the best cooking results, place the rack on shelf level 2.
- Place the vacuum-sealed food on the rack (next to each other if there are several bags).
- Select Sous-vide .
- Change the recommended temperature if necessary.
- Confirm with *OK*.
- Set further settings as necessary (see “Operation”).

Possible reasons for unsatisfactory results

The bag has opened:

- The seal was not clean or strong enough and has opened.
- The bag was damaged by a sharp bone.

The food has an unpleasant or strange taste:

- Incorrect storage of the food; the food was kept out of the refrigerator for too long.
- The food was contaminated with bacteria before it was vacuum sealed.
- Too much of ingredients such as spices was added.
- The bag or seal was not in perfect order.
- The vacuum was insufficient.
- The food was not eaten or chilled immediately after cooking.

Sous-vide (vacuum) cooking

The cooking durations given in the tables are guidelines only. We recommend selecting the shorter duration initially. You can cook for longer if necessary. The cooking duration only begins when the set temperature is reached.

Food	Added in advance		🌡️ [°C]	⌚ [min]
	Sugar	Salt		
Fish				
Atlantic cod fillet, 2.5 cm thick		x	54	35
Salmon fillet, 2–3 cm thick		x	52	30
Monkfish fillet		x	62	18
Pikeperch fillet, 2 cm thick		x	55	30
Vegetables				
Cauliflower florets, medium to large		x	85	40
Hokkaido pumpkin, sliced		x	85	15
Kohlrabi, sliced		x	85	30
Asparagus, white, whole	x	x	85	22–27
Sweet potato, sliced		x	85	18
Fruit				
Pineapple, sliced	x		85	75
Apples, sliced	x		80	20
Baby bananas, whole			62	10
Peaches, halved	x		62	25–30
Rhubarb chunks			75	13
Plums, halved	x		70	10–12
Other				
Beans, white, soaked in a ratio of 1:2 (beans to liquid)		x	90	240
Prawns, peeled and deveined		x	56	19–21
Hen's egg, whole			65–66	60
Scallops, removed from shell			52	25
Shallots, whole	x	x	85	45–60

🌡️ Temperature ⌚ Duration

Sous-vide (vacuum) cooking

Food	Added in advance		🌡️ [°C]		🕒 [min]
	Sugar	Salt	Medium*	Done*	
Meat					
Duck breast, whole		x	66	72	35
Saddle of lamb			58	62	50
Beef fillet steak, 4 cm thick			56	61	120
Beef rump steak, 2.5 cm thick			56	–	120
Pork tenderloin, whole		x	63	67	60

🌡️ Temperature 🕒 Duration

* Degree of cooking

The “well done” cooking degree uses a higher core temperature than “medium”, but results are not the same as being well-done in the traditional sense.

Sous-vide (vacuum) cooking

Reheating

Only reheat brassicas, such as kohlrabi and cauliflower, in combination with a sauce. Without sauce, an unpleasant cabbage-like taste and grey-brown colour may develop.

Food with a short cooking duration or which continues cooking during reheating, such as fish, is not suitable for reheating.

Preparation

Place the cooked food into ice water for approx. 1 hour directly after cooking. The rapid cooling prevents the food from continuing to cook, which helps retain the optimum cooked condition. Then store the food in the refrigerator at a maximum temperature of 5 °C.

Please note that the quality of the food decreases the longer it is stored.

We recommend that you do not store the food in the refrigerator for longer than 5 days before reheating.

Settings

Sous-vide 

Temperature: see table

Duration: see table

Sous-vide (vacuum) cooking

Reheating with the Sous-vide function

The durations specified in the table are guidelines only. You can increase the duration if necessary. The cooking duration only begins when the set temperature is reached.

Food	🌡️ [°C]		🕒 ² [min]
	Medium ¹	Done ¹	
Meat			
Saddle of lamb	58	62	30
Beef fillet steak, 4 cm thick	56	61	30
Beef rump steak, 2.5 cm thick	56	–	30
Pork tenderloin, whole	63	67	30
Vegetables			
Cauliflower florets, medium to large ³	85		15
Kohlrabi, sliced ³	85		10
Fruit			
Pineapple, sliced	85		10
Other			
Beans, white, soaked in a ratio of 1:2 (beans to liquid)	90		10
Shallots, whole	85		10

🌡️ Temperature, 🕒 Time

¹ Degree of cooking

The “well done” cooking degree uses a higher core temperature than “medium”, but results are not the same as being well-done in the traditional sense.

² Durations apply to vacuum-sealed food with an initial temperature of approx. 5 °C (refrigerator temperature).

³ Reheat only in sauce.

Further applications

Reheat

To reheat food which was cooked using the sous-vide method, use the Sous-vide  function (see “Sous-vide – Reheating”).

The steam oven is very effective at reheating food gently, without drying it out or cooking it further. The food will reheat evenly and does not need to be stirred during the reheating process.

You can reheat individual dishes or plated meals which have been prepared previously (e.g. meat, vegetables and potatoes).

Suitable containers

Small quantities can be reheated on a plate, larger quantities should be placed in a cooking container.

Time

The number of plates or containers has no bearing on the time.

The times listed in the table relate to an average portion per plate. Increase the duration for larger quantities.

Tips

- Do not reheat large items, such as a joint of roast meat, whole. Divide it into portions and reheat these as plated meals.
- Compact items, such as stuffed peppers, roulades or dumplings, should be cut in half.
- Reheat sauces separately. Exceptions are dishes such as goulash, which is cooked in sauce.
- Cover food when reheating it to avoid steam condensing on the crockery.
- Please note that breaded items, such as schnitzel, will not retain their crispness when they are reheated.

Heating food

- Cover the food being warmed up with a plate or foil that is resistant to temperatures up to 100 °C and to steam.
- Place the food on the rack or in a cooking container.

Settings

Reheat 

or

Steam cooking 

Temperature: 100 °C

Duration: see chart

Further applications

The durations specified in the table are guidelines only. We recommend selecting the shorter duration initially. You can increase the duration if necessary.

Food	🕒* [min]
Vegetables	
Carrots Cauliflower Kohlrabi Beans	6–7
Side dishes	
Pasta Rice	3–4
Potatoes, halved lengthways	12–14
Dumplings	15–17
Meat and poultry	
Sliced meat, 1.5 cm thick Roulades, sliced Goulash Lamb stew	5–6
Meatballs	13–15
Chicken escalopes Turkey escalopes	7–8
Fish	
Fish fillets, 2 cm thick	6–7
Fish fillets, 3 cm thick	7–8
Plated meals	
Spaghetti with tomato sauce	13–15
Roast pork, potatoes, vegetables	12–14
Stuffed pepper (halved), rice	13–15
Chicken fricassee, rice	7–8
Vegetable soup	2–3
Creamy soup	3–4

Further applications

Food	🕒* [min]
Consommé	2-3
Stew	4-5

🕒 Duration

* These times apply to food heated on a plate and covered with a plate.

Defrost

It is much quicker to defrost food in the steam oven than at room temperature.

 Risk of infection from bacteria. Bacteria such as salmonella can cause life-threatening food poisoning.

It is particularly important to observe food hygiene rules when defrosting fish and meat, and in particular when defrosting poultry.

Do not use the liquid produced during defrosting.

Process the food as required as soon as it has been defrosted.

Temperature

60 °C is the best temperature for defrosting.

Exception: 50 °C for minced meat and game

Before and after defrosting

Remove any packaging before defrosting.

Exceptions: Leave bread, biscuits and cakes in their packaging as otherwise they will absorb moisture and become soft.

Allow food to stand at room temperature for a few minutes after defrosting. The standing time is necessary to allow the even distribution of heat from the outside to the inside.

Cooking containers

Use a perforated container with a glass or condensate tray underneath it when defrosting food which will drip, such as poultry. This way food will not be lying in defrosted liquid.

Food which does not drip can be defrosted in a solid container.

Tips

- Fish, for instance, does not need to be fully defrosted before cooking. Defrost so that the surface is sufficiently thawed to take herbs and seasoning. Depending on the thickness of the fish, 2–5 minutes is generally enough.
- When defrosting food which has frozen together, e.g. berries and meat portions, separate them half-way through the defrosting time.
- Do not refreeze food once it has thawed.
- Defrost frozen pre-cooked meals according to the instructions on the packaging.

Settings

Defrost 

or

Steam cooking 

Temperature: see chart

Defrosting duration: see chart

Standing time: see chart

Further applications

The durations specified in the table are guidelines only. We recommend selecting the shorter defrosting time initially. You can increase the defrosting time longer if necessary.

Frozen food	Quantity	🌡️ [°C]	🕒 [min]	⌚ [min]
Dairy products				
Sliced cheese	125 g	60	15	10
Quark	250 g	60	20–25	10–15
Cream	250 g	60	20–25	10–15
Soft cheese	100 g	60	15	10–15
Fruit				
Apple sauce	250 g	60	20–25	10–15
Apple chunks	250 g	60	20–25	10–15
Apricots	500 g	60	25–28	15–20
Strawberries	300 g	60	8–10	10–12
Raspberries/currants	300 g	60	8	10–12
Cherries	150 g	60	15	10–15
Peaches	500 g	60	25–28	15–20
Plums	250 g	60	20–25	10–15
Gooseberries	250 g	60	20–22	10–15
Vegetables				
Frozen in a block	300 g	60	20–25	10–15
Fish				
Fish fillets	400 g	60	15	10–15
Trout	500 g	60	15–18	10–15
Lobster	300 g	60	25–30	10–15
Small shrimps	300 g	60	4–6	5
Ready meals				
Meat, vegetables, side dishes/ stew/soup	480 g	60	20–25	10–15
Meat				
Roast meat, sliced	125–150 g each	60	8–10	15–20

Further applications

Frozen food	Quantity	🌡️ [°C]	⌚ [min]	⌛ [min]
Minced meat	250 g	50	15–20	10–15
	500 g	50	20–30	10–15
Goulash	500 g	60	30–40	10–15
	1000 g	60	50–60	10–15
Liver	250 g	60	20–25	10–15
Saddle of hare	500 g	50	30–40	10–15
Saddle of venison	1000 g	50	40–50	10–15
Cutlets/chops/sausages	800 g	60	25–35	15–20
Poultry				
Chicken	1000 g	60	40	15–20
Chicken thighs	150 g	60	20–25	10–15
Chicken escalopes	500 g	60	25–30	10–15
Turkey legs	500 g	60	40–45	10–15
Baked goods				
Puff pastries/yeast-dough pastry	–	60	10–12	10–15
Creamed mixture cakes/biscuits	400 g	60	15	10–15
Bread/rolls				
Bread rolls	–	60	30	2
Rye bread, sliced	250 g	60	40	15
Wholegrain bread, sliced	250 g	60	65	15
White bread, sliced	150 g	60	30	20

🌡️ Temperature ⌚ Defrosting time ⌛ Standing time

Further applications

Blanching

Blanch vegetables before freezing them. Blanching helps maintain the quality of the produce when it is frozen.

Blanching vegetables also helps them retain their original colour.

- Put the prepared vegetables into a perforated cooking container.
- Once blanched, plunge the vegetables into ice cold water to cool them down quickly. Drain them well.

Settings

Further  | Blanching

or

Steam cooking 

Temperature: 100 °C

Blanching time: 1 minute

Bottling

Only use unblemished, fresh produce which is in good condition for bottling.

Glass jars

Use clean glass jars and accessories and check them for any defects. Glass jars with twist off lids or glass lids with a rubber seal are suitable.

Make sure that all the jars are the same size so that bottling is carried out evenly.

After you have filled the jars with the bottled produce, clean the glass rims with a clean cloth and hot water and then seal the jars.

Fruit

Sort fruit carefully, rinse it briefly but thoroughly and allow it to drain. Take great care when cleaning soft fruit as it is very delicate and squashes easily.

Remove any peel, stalks, cores or stones. Cut up large fruit. For example, cut apples into slices.

If you are bottling fruit with stones (e.g. plums, apricots) without removing the stones, pierce the fruit several times with a fork or wooden skewer as otherwise it will burst.

Vegetables

Rinse, clean and cut up vegetables.

Vegetables should be blanched before bottling to help them retain their colour (see “Special applications” – “Blanching”).

Fill volume

Fill the glass jars with produce up to a maximum of 3 cm below the rim. Do not pack it down as this will damage the cell walls of the produce. Tap the jar gently onto a cloth to help distribute the contents evenly. Fill the jars with liquid. The produce must be completely covered.

Use a sugar solution for fruit and a salt or vinegar solution for vegetables.



Tips

- Make use of residual heat by leaving the jars in the oven for 30 minutes after it has switched off.
- Then cover the jars with a cloth and allow to cool for approx. 24 hours.

Bottling food

- Place the rack in shelf level 1.
- Place the jars on the rack. The jars must not touch each other.

Settings

Further  | Bottling
or
Steam cooking 

Temperature: see table
Bottling duration: see table

Further applications

Food to be bottled	🌡️ [°C]	🕒* [min]
Berries		
Currants	80	50
Gooseberries	80	55
Cranberries	80	55
Fruit with stones		
Cherries	85	55
Mirabelle plums	85	55
Plums	85	55
Peaches	85	55
Greengages	85	55
Fruit with pips		
Apples	90	50
Apple sauce	90	65
Quinces	90	65
Vegetables		
Beans	100	120
Broad beans	100	120
Gherkins	90	55
Beetroot	100	60

🌡️ Temperature 🕒 Duration

* Bottling times apply to 1.0 l jars. If using 0.5 l jars, reduce the duration by 15 minutes. If using 0.25 l jars, reduce the duration by 20 minutes.

Disinfect items

The steam oven can be used to disinfect baby bottles and other containers so that at the end of the programme they are as germ free as they would have been had they been boiled. Check beforehand that all parts, teats etc. are declared by the manufacturer to be heat resistant to 100 °C and also that they can withstand hot steam.

Dismantle, clean and thoroughly rinse baby bottles. All parts of the bottles must be completely dry before they are reassembled to keep them germ free.

- Place the individual items on the rack or in a perforated container (on their sides or with the opening facing downwards) ensuring that they do not touch one another to allow hot steam to reach them from all sides.

Settings

Further  | Disinfect items

Duration: 1 minute to 10 hours

or

Steam cooking 

Temperature: 100 °C

Duration: 15 minutes

Prove dough

- Prepare the dough according to the recipe.
- Place the dough, uncovered, in a bowl on the rack.

Settings

Further  | Prove dough

Duration: as per recipe instructions

or

Steam cooking 

Temperature: 40 °C

Duration: as per recipe instructions

Further applications

Heating damp flannels

- Moisten the flannels and then roll them up.
- Place them beside one another in a perforated cooking container.

Settings

Automatic programmes  | Special | Heat damp flannels

or

Steam cooking 

Temperature: 70 °C

Cooking duration: 2 minutes

Dissolve gelatine

- Soften **gelatine leaves** by leaving them in a bowl of cold water for 5 minutes. The gelatine leaves have to be fully covered with water. Remove the gelatine leaves from the bowl and squeeze them out. Empty the bowl. Place the squeezed gelatine leaves back in the bowl.
- Place **gelatine powder** in a bowl and add water according to the instructions on the packaging.
- Cover the bowl and place on the rack.

Settings

Automatic programmes  | Special | Dissolve gelatine

or

Steam cooking 

Temperature: 90 °C

Cooking duration: 1 minute

Decrystallise honey

- Loosen the lid and place the jar of honey in a perforated container.
- Stir the honey once during the cooking duration.

Settings

Automatic programmes  | Special | Decrystallise honey

or

Steam cooking 

Temperature: 60 °C

Cooking duration: 90 minutes (irrespective of the size of jar or the amount of honey in the jar)

Melt chocolate

You can use the steam oven for melting any type of chocolate.

When using a cake covering, place it in a perforated cooking container, leaving it in its packaging.

- Break the chocolate into small pieces.
- Place larger quantities in a solid cooking container and smaller quantities in a cup or a bowl.
- Cover the container or the dish with a lid or with foil that is resistant to temperatures up to 100 °C and to hot steam.
- Stir large quantities once halfway through cooking.

Settings

Automatic programmes  | Special | Melt chocolate

or

Steam cooking 

Temperature: 65 °C

Cooking duration: 20 minutes

Further applications

Make yoghurt

To make yoghurt, you will need either fresh live yoghurt or yoghurt culture, obtainable from health food shops.

Use natural yoghurt with live culture and without additives. Heat-treated yoghurt is not suitable.

The yoghurt must be fresh (short storage time).

You can use either unchilled long-life milk or fresh milk.

Long-life milk can be used as it is – no further preparation is required. Fresh milk must first be heated to 90 °C (do not boil it) and then cooled down to 35 °C. Fresh milk will give a better set than long-life milk.

The yoghurt and milk should have the same percentage fat.

Do not move or shake the jars whilst the yoghurt is thickening.

Immediately after preparation, leave the yoghurt to cool in the fridge.

How well home-prepared yoghurt sets will depend on the consistency, fat content and the cultures used in the starter yoghurt. Not all yoghurts are suitable for use as starter yoghurt.

Tip: When using yoghurt enzyme, yoghurt can be made from a milk / cream mixture. Mix $\frac{3}{4}$ litre milk with $\frac{1}{4}$ litre cream.

- Mix 100 g yoghurt with 1 l milk or make up the mixture with yoghurt enzyme, following the instructions on the packaging.
- Pour the mixture into jars and seal the jars.
- Place the sealed jars into a perforated cooking container or on the rack. The jars must not touch each other.
- Straight after the cooking duration has finished, place the jars in the refrigerator. Take care not to shake the jars unnecessarily.

Settings

Automatic programmes  | Special |
Make yoghurt

or

Steam cooking 
Temperature: 40 °C
Duration: 5 hours

Possible reasons for unsatisfactory results

Yoghurt has not set:

Incorrect storage of starter yoghurt, too much time out of the refrigerator, e.g. in transportation, damaged packaging, milk not sufficiently heated.

Liquid has separated:

The jars were moved, yoghurt was not cooled down quickly enough.

Yoghurt is gritty:

Milk was overheated or in poor condition, milk and starter yoghurt not evenly stirred.

Cook bacon

The bacon does not brown.

- Place the bacon (diced or rashers) in a solid cooking container.
- Cover the container with foil that is temperature-resistant up to 100 °C and resistant to steam.

Settings

Automatic programmes  | Special |
Render fat

or

Steam cooking 

Temperature: 100 °C

Cooking duration: 4 minutes

Sweat onions

Sweating means cooking the onions in their own juices, with the addition of a little fat if necessary.

- Cut the onions up into small pieces and place them in a solid cooking container with a little butter.
- Cover the container with foil that is temperature-resistant up to 100 °C and resistant to steam.

Settings

Automatic programmes  | Special |
Sweat onions

or

Steam cooking 

Temperature: 100 °C

Cooking duration: 4 minutes

Further applications

Extracting juice with steam

This appliance is ideal for extracting juice from soft, firm and hard fruit.

It is best to use overripe fruit, as the riper the fruit, the greater the quantity of juice produced. Very ripe fruit will also produce a more intense flavour.

Preparation

Sort and clean the fruit. Cut out any blemishes.

Remove the stalks from grapes and morello cherries as these are bitter. Berries do not need to have their stalks removed.

Cut larger fruit such as apples into chunks of approximately 2 cm in size. The harder the fruit, the smaller the pieces should be.

Tips

- Try experimenting with mild and tart fruit.
- Adding sugar will increase the quantity of juice produced and improve the flavour. Sprinkle the fruit with sugar and leave to absorb for a few hours before juicing. For 1 kg of sweet fruit add 50–100 g of sugar, and for 1 kg of tart fruit add 100–150 g of sugar.
- If you wish to bottle the juice rather than consume it straight away, pour it whilst hot into hot, sterilised bottles, and then seal immediately with sterilised tops.

Extracting juice from fruit

- Put the prepared fruit into a perforated cooking container.
- Place a solid container or a glass or condensate tray (depending on the model) underneath to catch the juice.

Settings

Steam cooking 

Temperature: 100 °C

Duration: 40–70 minutes

Skinning vegetables and fruit

- Cut a cross in the top of tomatoes, nectarines, etc. This will allow the skin to be removed more easily.
- Place the fruit/vegetables in a perforated cooking container.
- To blanch almonds, it is important to plunge them into cold water as soon as they are taken out of the oven, otherwise the skin cannot be removed.

Settings

Steam cooking 

Temperature: 100 °C

Duration: see table

Food	 [min]
Apricots	1
Almonds	1
Nectarines	1
Peppers	4
Peaches	1
Tomatoes	1

 Duration

Apple storage

You can treat homegrown apples in the steam oven to increase the length of time for which you can store them. Once treated, the apples will keep for 5 to 6 months when stored in a dry, cool and well-ventilated place. This method is only suitable for apples and not for other types of fruit.

Settings

Automatic programmes  | Fruit | Apples | Whole

or

Steam cooking 

Temperature: 50 °C

Preserving time: 5 minutes

Making eierstich

- Mix 6 eggs with 375 ml milk (do not beat into a foam).
- Season the egg and milk mixture and pour into a solid cooking container greased with a little butter.

Settings

Steam cooking 

Temperature: 100 °C

Cooking duration: 4 minutes

Automatic programmes

The wide range of automatic programmes enable you to achieve excellent results with ease.

Categories

The  automatic programmes are sorted into categories to provide a better overview. Simply select the appropriate programme for the type of food you are cooking and follow the instructions in the display.

Using automatic programmes

- Select Automatic programmes .

A list will appear.



- Select the desired food category (e.g. Fish).

The automatic programmes available for the category selected will then appear.

- Select the desired automatic programme.
- Follow the instructions on the display.

Tip: Use  Info to display information such as how to place or turn the food depending on the cooking programme.

Usage notes

- The degree of cooking is represented by a bar with seven segments. Using the navigation area you can set the desired degree of cooking.
- The weights specified in the automatic programmes refer to the weight per piece. For example, you can cook just one piece of salmon weighing 250 g or 10 pieces of salmon, each weighing 250 g, at the same time.
- The steam oven compartment needs to cool to room temperature before starting an automatic programme.
- When you place food into the hot oven compartment, be careful when opening the door. Hot steam may escape. Step back and wait until the steam has dissipated. Avoid contact with hot steam, and do not touch the hot oven compartment walls. Danger of burning and scalding.
- For some automatic programmes, the start time can be delayed using Start at or Finish at.
- Select the  sensor control to cancel an automatic programme. When Cancel process? appears, select Yes and confirm with OK.
- If by the end of an automatic programme the food is not cooked enough for your taste, select Cont. cooking.
- Automatic programmes can also be saved as User programmes. To do this, select the  sensor control after an automatic programme has finished.

You can create and save up to 20 of your own programmes.

- You can combine up to 9 cooking stages to accurately programme your favourite or most frequently used recipes. In each cooking stage, you can select settings such as the function, temperature and cooking duration.
- You can enter the name of the programme for your recipe.

When you call up and start your programme again, it will run automatically.

There are different ways of creating a user programme:

- At the end of an automatic programme or special application, save it as a user programme.
- Save a cooking programme after running it with a set cooking duration.

Then enter a programme name.

Creating user programmes

- Select **User programmes** .
- Select **Create programme**.

You can now specify the settings for the first cooking stage.

Follow the instructions in the display:

- Select and confirm the desired settings.
- Select **Finish cooking stage**.

All settings for the first cooking stage have now been set.

You can add more cooking stages, for example, if you want to add another cooking function to follow on from the first.

- If additional cooking stages are required, select **Add cooking stage** and proceed as per the 1st cooking stage.

If you want to check the settings or to change them at a later date, select the cooking stage in question.

- When you have finished setting all the cooking stages, select **Save**.
- Enter the programme name.
- Select **✓**.

A message will appear in the display confirming that the programme name has been saved.

- Confirm with **OK**.

You can start the saved programme immediately, delay the start or change the cooking stages.

User programmes

Starting user programmes

- Place the food in the oven compartment.
- Select User programmes .
- Select the desired programme.
- Select Allow.

Depending on the programme settings, the following menu options appear in the display:

- Start now
The programme will start immediately. The oven heating will switch on immediately.
 - Finish at
Specify the time when you want the programme to stop. The oven heating will switch off automatically at the time you have set.
 - Start at
Specify the time when you want the programme to start. The oven heating will switch on automatically at the time you have set.
 - Show cooking stages
A summary of your settings will appear on the display.
- Select the desired menu option.

The programme selected will begin straight away or at the time set.

- At the end of the programme, select the  sensor control.

Changing cooking stages

Cooking stages in automatic programmes that have been saved under a different name cannot be changed.

- Select User programmes .
- Select the programme you want to change.
- Select Change programme.
- Select the cooking stage that you want to change or Add cooking stage to add another cooking stage.
- Select and confirm the desired settings.
- If you want to start the modified programme without changing it, select Start programme.
- Select Save when you have changed all the settings.

A message will appear in the display confirming that the programme name has been saved.

- Confirm with OK.

The saved programme has been changed and you can start it immediately or delay the start.

Changing the name

- Select User programmes .
- Select the programme you want to change.
- Select Change name.
- Change the programme name.
- Select ✓.

A message will appear in the display confirming that the programme name has been saved.



- Confirm with *OK*.

The programme has been renamed.

Deleting user programmes



- Select User programmes .
- Select the programme you want to delete.
- Select Delete programme.
- Confirm the request with *Yes*.

The programme is deleted.

Go to Further  | Settings  | Factory default | User programmes **to delete all user programmes at the same time.**

Note for test institutes



Test food in accordance with EN 60350-1 (steam cooking function)

Test food	Cooking container(s)	Quantity [g]	 ⁴	 [°C]	 [min]
Steam replenishment					
Broccoli (8.1)	1x DGGL 1/2-40L	300	Any	100	3
Steam distribution					
Broccoli (8.2)	2x DGGL 1/2-40L	max.	Any ³	100	3
Appliance capacity					
Peas (8.3)	4x DGGL 1/2-40L	875 in each	2, 4 ⁴	100	5

⁴ Shelf level(s),  Temperature,  Cooking duration

- Place the glass tray or condensate tray (depending on the model) in shelf level 1.
- Place the test food in a cold oven compartment (before the heating-up phase begins).
- Place 2x DGGL 1/2-40L containers adjacent to one another in the shelf level.
- Place 2x DGGL 1/2-40L containers adjacent to one another in each of the shelf levels.
- The test is finished when the temperature measures 85 °C in the coolest place.

Menu cooking test food¹ (steam cooking function)

Test food	Cooking containers	Quantity [g]	 ⁴	 [°C]	Height [cm]	 [min]
Potatoes, waxy, quartered ³	1 x 1/2 DGGL-40 L	800	4	100	–	17
Salmon fillet, frozen, not defrosted	1 x 1/2 DGGL-40 L	4 x 150	2	100	< 2.5 ≥ 2.5 ≤ 3.2 > 3.2	9 10 11
Broccoli florets	1 x 1/2 DGGL-40 L	600	3	100	–	4

⁴ Shelf level,  Temperature,  Cooking duration

- For instructions, see “Steam cooking – Menu cooking”.
- Place the glass tray or condensate tray (depending on the model) on shelf level 1.
- Place the 1st test food item (potatoes) in the cold oven compartment (before the heating-up phase begins).

 Risk of injury caused by hot surfaces.

The steam oven gets hot during operation. You could burn yourself on the oven compartment, side runners or accessories.

Allow the oven compartment, side runners and accessories to cool before cleaning.

 Risk of injury due to electric shock.

The steam from a steam cleaning appliance could reach live electrical components and cause a short circuit.

Never use a steam cleaner for cleaning.

Surfaces can discolour or alter if unsuitable cleaning agents are used. All surfaces are susceptible to scratching. Scratches on glass can in some circumstances lead to breakage.

Use only domestic washing-up liquid to clean the appliance.

Remove all cleaning agent residues immediately.

Do not use cleaning agents or washing-up liquids containing aliphatic hydrocarbons as these could cause the seals to swell.

If soiling is left on for any length of time, it may become impossible to remove.

Surfaces may suffer discolouration or damage.

It is therefore best to remove any soiling immediately.

- The appliance and accessories should be cleaned and dried thoroughly after each use.
- Leave the appliance door open until the oven compartment is completely dry.

Tip: If the appliance is not going to be used for a longer period of time – during a holiday, for example – it should be thoroughly cleaned and dried beforehand to prevent the build-up of odours and so on. Leave the door open afterwards.

Cleaning and care

Unsuitable cleaning agents

To avoid damaging the surfaces of your appliance, do not use:

- Cleaning agents containing soda, ammonia, acids or chlorides
- Cleaning agents containing descaling agents
- Abrasive cleaning agents, e.g. powder cleaners and cream cleaners
- Solvent-based cleaning agents
- Stainless steel cleaning agents
- Dishwasher cleaner
- Glass cleaning agents
- Cleaning agents for ceramic glass hobs
- Hard, abrasive brushes or sponges (e.g. pot scourers, brushes or sponges which have been previously used with abrasive cleaning agents)
- Melamine eraser blocks
- Sharp metal scrapers
- Wire wool
- Stainless steel spiral pads
- Spot cleaning with mechanical cleaning agents
- Oven cleaners or sprays

Cleaning the steam oven front

- Clean the appliance front with a clean, soft sponge and a solution of warm water and washing-up liquid.
- After cleaning, wipe the surfaces dry using a soft cloth.

Tip: A clean, damp microfibre cloth without cleaning agent can also be used.

Cleaning the oven compartment

The oven compartment, the door seal, the drip channel and the inside of the door should be cleaned and dried after each use.

- Remove:
 - condensate using a sponge or absorbent cloth
 - light, greasy soiling with a clean sponge and a solution of washing-up liquid and hot water.
- After cleaning, wipe the surface with clean water to remove any cleaning agent residues.
- Then wipe the surfaces dry using a cloth.

After prolonged use, the **floor heater** can become discoloured by drops of liquid, but this does not impair the function.

The **door seal** is designed to last the lifetime of the appliance. Should it for any reason need replacing, please contact the Customer Service Department (see the end of these operating instructions).

Cleaning the automatic door opener

Ensure that the door opener does not become soiled with food residues.

- Wipe away soiling **immediately** with a clean sponge and a solution of washing-up liquid and hot water.
- After cleaning, wipe the surface with clean water to remove any cleaning agent residues.

Cleaning the water container

- Remove the water container after each use.
- Remove the spill guard.
- Empty the water container.
- Rinse the water container by hand and then dry it to prevent limescale.
- Push the spill guard back onto the water container. Make sure the spill guard engages correctly.

Accessories

All accessories are dishwasher safe.

Cleaning the condensate tray, rack and cooking containers

- Wash and dry the condensate tray, rack and cooking containers after each use.
- Any bluish discolouration on the cooking containers can be removed with vinegar. Then rinse with clean water.

Cleaning and care

Cleaning the side runners

The side runners are suitable for cleaning in a dishwasher.

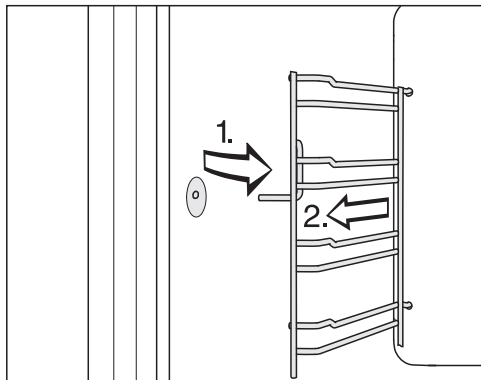

- Pull the side runners out of holder (1.) and remove them (2.).
- The side runners can be washed in the dishwasher or by hand with a solution of warm water and a little washing-up liquid applied with a clean sponge or cloth.

Reassemble by following these instructions in reverse order.

- Carefully refit the side runners.

If the side runners are not correctly inserted, there is no anti-tip protection.

Descaling the steam oven

We recommend using Miele descaling tablets (see “Optional accessories”) to descale the appliance. These have been specially developed for use with Miele appliances to optimise the descaling process. Other descaling agents, which contain other acids besides citric acid and/or other undesirable substances, such as chlorides for example, could cause damage to the product. Moreover, the descaling result required could not be guaranteed if the descaling solution was not of the appropriate concentration.

Do not spill descaling agent onto metal surfaces. This can cause marks to appear.

However, should any descaling agent get onto these surfaces, wipe it away immediately.

The steam oven has to be descaled after a certain number of operating hours. When it needs descaling, the number of uses remaining will be shown in the display. The steam oven will lock after the last remaining cooking process.

We recommend that you descale the appliance before it locks out.

During the descaling process, the water container must be rinsed out and re-filled with fresh water.

The **Start at** and **Finish at** functions are not available while descaling is being carried out.

- Switch the steam oven on and select **Descal** .

The message **Please wait** will appear on the display. The descaling process is being prepared. This may take several minutes. As soon as the appliance is ready you will be prompted to fill the water container.

- Fill the water container with lukewarm fresh tap water up to the level marker  and drop 2 Miele descaling tablets in it.
- Wait until the descaling tablets have dissolved.
- Push the water container into the appliance.
- Confirm with **OK**.

The time remaining will appear in the display. The descaling process will now begin.

Do not switch the steam oven off during the descaling process, otherwise the whole process will have to be started from the beginning again.

The water container will need emptying and refilling with fresh tap water twice during descaling.

- Follow the instructions on the display.
- Confirm each with **OK**.

Once the time left has elapsed, **Finished** will appear on the display and a buzzer will sound.

- Switch the steam oven off.
- Remove the water container and take out the spill guard.
- Empty and dry the water container.
- Allow the oven compartment to cool down.
- Then dry the oven compartment.
- Leave the appliance door open until the oven compartment is completely dry.

Problem solving guide

Many malfunctions and faults that can occur in daily operation can be easily remedied. Time and money will be saved because a service call will not be needed.

The following guide may help you to find the reason for a malfunction or a fault, and to correct it.

Problem	Cause and remedy
You cannot switch the appliance on.	<p>The fuse has tripped.</p> <ul style="list-style-type: none">■ Reset the trip switch in the fuse box or replace the fuse in the plug (see data plate for minimum fuse rating).
	<p>There may be a technical fault.</p> <ul style="list-style-type: none">■ Disconnect the appliance from the mains connection for approximately 1 minute by:<ul style="list-style-type: none">– Tripping the relevant mains fuse or unscrewing the fuse completely, or– Switching off the residual current protection device■ If, after resetting the trip switch in the mains fuse box or the residual current protection device, the steam oven will still not turn on, contact a qualified electrician or Miele Service.
The oven compartment does not heat up.	<p>Demo mode is active. The steam oven can be operated, however, the heating elements will not work.</p> <ul style="list-style-type: none">■ Deactivate demo mode (see “Settings – Showroom programme”).
	<p>The oven compartment has been warmed up by a warming drawer in operation underneath it.</p> <ul style="list-style-type: none">■ Open the door and let the oven compartment cool down.

Problem solving guide

Problem	Cause and remedy
<p>The sensor controls do not respond.</p>	<p>You have selected the Display QuickTouch Off setting. So when the steam oven is switched off, the sensor controls do not respond.</p> <ul style="list-style-type: none"> ■ As soon as the steam oven is switched on, the sensor controls will respond. If you want the sensor controls to always respond even when the steam oven is switched off, select the Display QuickTouch On setting.
	<p>The steam oven is not connected to the power supply.</p> <ul style="list-style-type: none"> ■ Check that the steam oven plug is correctly inserted into the socket. ■ Check whether the fuse has tripped. Contact a qualified electrician or the Miele Customer Service Department.
	<p>There is a fault with the controls.</p> <ul style="list-style-type: none"> ■ Touch and hold the ⓘ On/Off button until the display switches off and the steam oven restarts.
<p>The fan can still be heard after the appliance has been switched off.</p>	<p>The fan is still running. The appliance is fitted with a fan which removes steam from the oven. The fan will continue to run for a while after the appliance has been switched off. It will switch itself off automatically after a while.</p>
<p>A humming sound can be heard after switching on the appliance, during operation and after switching off the appliance.</p>	<p>It is quite normal and does not indicate any fault with the appliance. It happens when water is being pumped through the system.</p>
<p>After moving house, the steam oven no longer switches from the heating-up phase to the cooking phase.</p>	<p>The boiling temperature of the water has changed as the altitude of the new location for the appliance differs from the old one by at least 300 m.</p> <ul style="list-style-type: none"> ■ To adjust the boiling temperature, you need to descale the steam oven (see “Cleaning and care – Descaling the steam oven”).

Problem solving guide

Problem	Cause and remedy
<p>During operation an unusually large amount of steam escapes, or steam escapes from parts of the oven where it does not usually.</p>	<p>The door is not properly closed.</p> <ul style="list-style-type: none"> ■ Close the door.
	<p>The door seal is not correctly fitted.</p> <ul style="list-style-type: none"> ■ Press it in all the way round the door to make sure it is fitted evenly.
	<p>The door seal is damaged, e.g. cracks can be seen.</p> <ul style="list-style-type: none"> ■ Replace the door seal. This can be ordered from Miele (see the end of this booklet for contact details).
<p>A whistling sound is heard when the appliance is switched on again.</p>	<p>When the door is closed, the pressure has to equalise, which can cause a whistling sound. This is not a fault.</p>
<p>The <small>Start at and Finish at</small> functions are not available.</p>	<p>The temperature in the oven compartment is too high, e.g. after a programme has finished.</p> <ul style="list-style-type: none"> ■ Open the door and let the oven compartment cool down.
	<p>These functions are not available with Descale.</p>
<p>The oven interior lighting is not working.</p>	<p>The lamp is defective.</p> <ul style="list-style-type: none"> ■ Call Miele Service to have the lamp replaced.
<p>F44</p>	<p>Communication fault</p> <ul style="list-style-type: none"> ■ Switch the steam oven off and then back on again after a few minutes. ■ If the same message appears again, call the Service Department.
<p>F and other fault codes</p>	<p>Technical fault.</p> <ul style="list-style-type: none"> ■ Switch the appliance off and contact Miele.

Miele offer a comprehensive range of useful accessories as well as cleaning and conditioning products for your Miele appliances.

These products can be ordered through the Miele Webshop.

They can also be ordered from Miele (see end of this booklet for contact details) or from your Miele dealer.

Containers

Miele offers a wide range of containers. Their dimensions and functions are tailored perfectly to Miele appliances. Detailed information on the individual products is available on the Miele website.

- Perforated cooking containers in various sizes
- Solid cooking containers in various sizes

Cleaning and care products

- Descaling tablets (6)
- All-purpose microfibre cloth for removing finger marks and light soiling

Service

Contact in case of malfunction

In the event of any faults which you cannot remedy yourself, please contact your Miele Dealer or Miele Service.

Contact information for Miele Service can be found at the end of this document.

Please note that telephone calls may be monitored and recorded for training purposes and that a call-out charge will be applied to service visits where the problem could have been resolved as described in this booklet.

Please quote the model and serial number of your appliance when contacting Miele. This information can be found on the data plate.

This information is given on the data plate, which is visible on the front frame of the oven when the door is fully open.

Warranty

For information on the appliance warranty specific to your country please contact Miele. See back cover for address.

In the UK, your appliance warranty is valid for 2 years from the date of purchase. However, you must activate your cover by calling 0330 160 6640 or registering online at www.miele.co.uk.

Safety instructions for installation

 Risk of damage from incorrect installation.
Incorrect installation can cause damage to the steam oven.
The steam oven must only be installed by a qualified person.

▶ The connection data (frequency and voltage) on the steam oven's data plate absolutely must correspond with those of the electricity supply in order to ensure that no damage can occur to the steam oven.

Compare this data before connecting the appliance. If in any doubt, consult a qualified electrician.

▶ Multi-socket adapters and extension leads do not guarantee the required safety of the appliance (fire hazard). Do not use them to connect the steam oven to the power supply.

▶ The socket should be easily accessible after the steam oven has been installed.

▶ The steam oven must be positioned so that you can see the contents of a cooking container placed on the top shelf level. Otherwise there is a risk of injuries or spillages of hot food.

Installation

Building-in dimensions

All dimensions are given in mm.

Installation in a tall unit

The furniture housing unit must not have a back panel fitted behind the building-in niche.

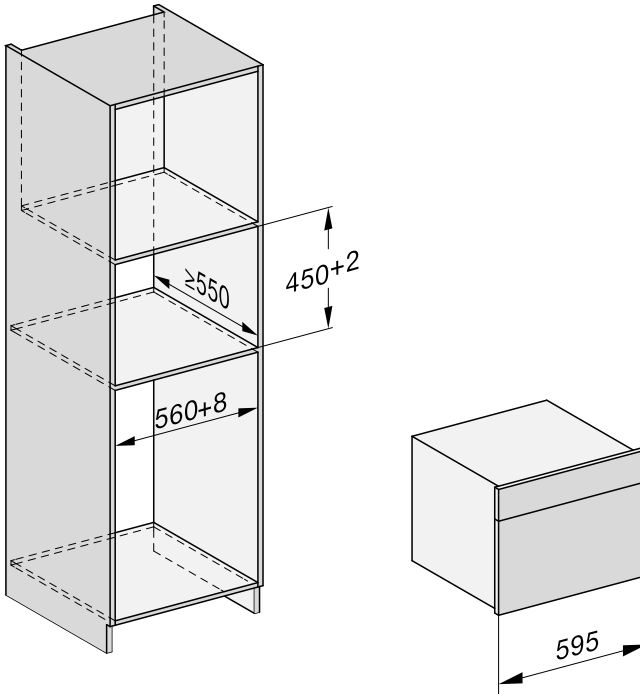

Installation in a base unit

The furniture housing unit must not have a back panel fitted behind the building-in niche.

When building the steam oven into a base unit underneath an electric or induction hob, please also observe the installation instructions for the hob as well as the building-in depth required for the hob.

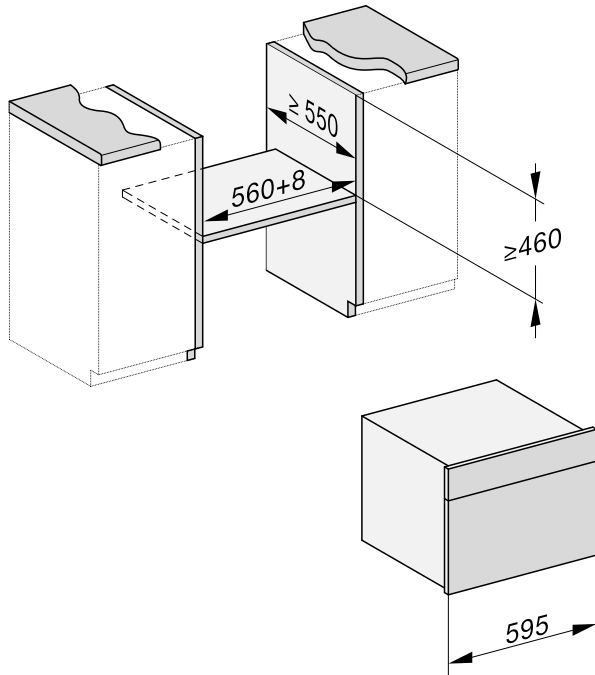

Installation

Side view

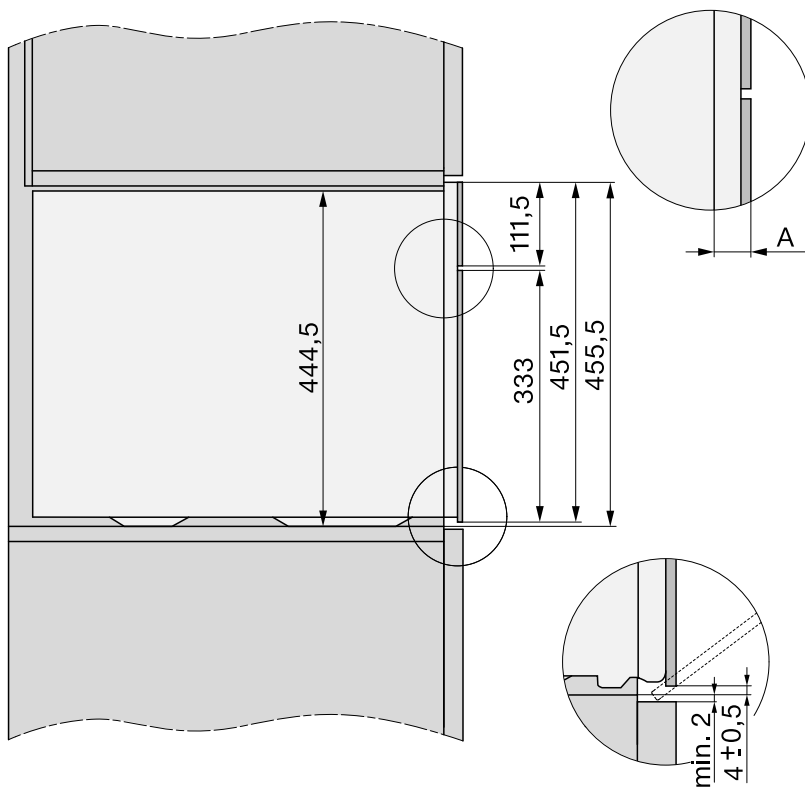

- A** Glass front: 22 mm
- Metal front: 23.3 mm

Connection and ventilation

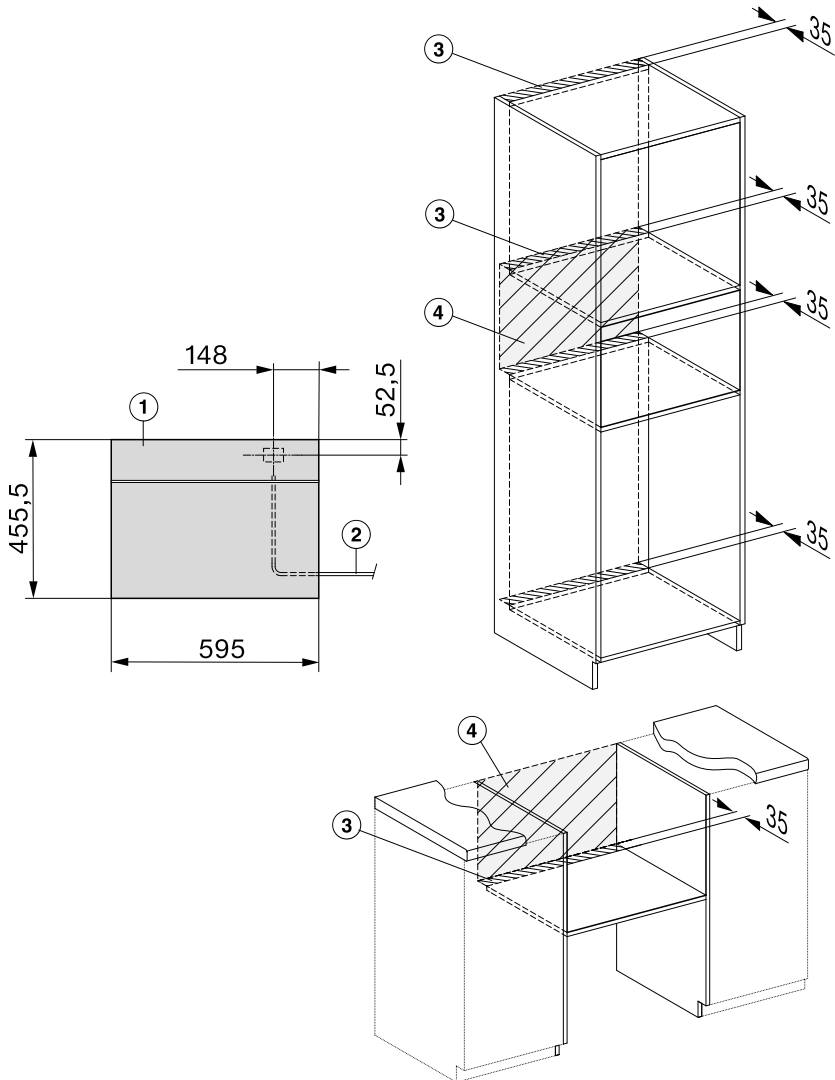

- ① View from the front
- ② Power cable, L = 2000 mm
- ③ Ventilation cut-out, min. 180 cm²
- ④ No connections permitted in this area

Installation

Installing the steam oven

- Connect the mains cable to the steam oven.

Risk of damage from incorrect transportation.

Lifting the steam oven by the door handle could cause damage to the door.

Use the handle cut-outs on the side of the casing to lift the appliance.

The steam generator may malfunction if the steam oven is not on a level surface.

The maximum deviation from the horizontal that can be tolerated is 2°.

- Push the steam oven into the housing unit and align it.
When doing so make sure that the power cable does not get trapped or damaged.
- Open the door.

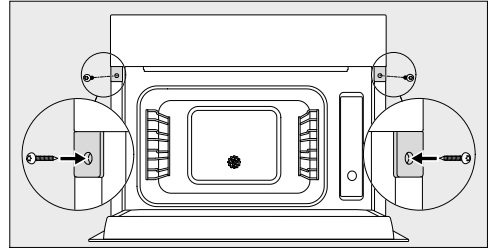

- Secure the steam oven to the side walls of the unit using the wood screws supplied (3.5 x 25 mm).
- Connect the steam oven to the electricity supply.
- Check all functions of the steam oven are working correctly in accordance with the operating instructions.

Electrical connection

We recommend that you connect the steam oven to the power supply using a suitable switched electrical socket. This makes it easier to perform servicing work. The socket must be easily accessible after the steam oven has been installed.

 Risk of damage from incorrect connection.

Installation, repairs and other maintenance work by unqualified persons could be dangerous. Miele cannot be held liable for unauthorised work. Miele cannot be held liable for damage or injury caused by the lack of or inadequacy of an on-site earthing system (e.g. electric shock).

If the plug is removed from the connection cable or if the cable is supplied without a plug, the steam oven must be connected to the electrical supply by a suitably qualified electrician.

If the socket is no longer accessible, or if a hard-wired connection is installed, an additional means of disconnection must be provided for all poles. A suitable means of disconnection would include switches with an all-pole contact gap of at least 3 mm. These include circuit breakers, fuses and contactors. The required connection data is provided on the data plate. Please ensure that these details match the electrical supply.

After installation, ensure that all electrical components are shielded and cannot be accessed by users.

Total power rating

See data plate

Connection data

The connection data is quoted on the data plate. Please ensure these match the household mains supply.

Residual current device

For extra safety, it is advisable to protect the steam oven with a suitable residual current device (RCD) with a trip range of 30 mA.

Replacing the mains connection cable

When replacing the mains connection cable, please use cable type H 05 VV-F with a suitable cross-section. These cables are available from the manufacturer or from Miele Service.

Installation

Disconnecting from the mains

 Risk of electric shock from mains voltage.

There is a risk of electric shock if the appliance is reconnected to the mains supply during repair or service work.

After disconnection, ensure the appliance cannot be switched back on by mistake.

To disconnect the appliance from the mains power supply, do one of the following depending on installation:

Safety fuses

- Completely remove the fuse links from the screw caps.

Automatic circuit breakers

- Press the test button (red) until the middle button (black) springs out.

Built-in circuit breakers

- For circuit breakers of at least type B or C, switch the lever from 1 (on) to 0 (off).

Residual current device (RCD)

- Residual current device: switch the main switch from 1 (on) to 0 (off) or press the test button.

Conformity declaration

Miele hereby declares that this steam oven complies with Directive 2014/53/EU.

The complete text of the EU declaration of conformity is available from one of the following internet addresses:

- Products, Download from www.miele.co.uk
- For service, information, operating instructions etc: go to www.miele.co.uk/domestic/customer-information-385.htm and enter the name of the product or the serial number

Frequency band of the WiFi module	2.4000 GHz – 2.4835 GHz
-----------------------------------	-------------------------

Maximum transmitting power of the WiFi module	< 100 mW
---	----------



United Kingdom

Miele Co. Ltd.
Fairacres, Marcham Road
Abingdon, Oxon, OX14 1TW
Tel: 0330 160 6600
Internet: www.miele.com

Australia

Miele Australia Pty. Ltd.
ACN 005 635 398
ABN 96 005 635 398
1 Gilbert Park Drive
Knoxfield, VIC 3180
Tel: 1300 464 353
Internet: www.miele.com.au

China

Miele (Shanghai) Trading Ltd.
1-3 Floor, No. 82 Shi Men Yi Road
Jing' an District
200040 Shanghai, PRC
Tel: +86 21 6157 3500
Fax: +86 21 6157 3511
E-mail: info@miele.cn
Internet: www.miele.cn

Miele (Hong Kong) Limited

41/F - 4101, Manhattan Place
23 Wang Tai Road
Kowloon Bay, Hong Kong
Tel: (852) 2610 1025
Fax: (852) 3579 1404
Email:
customerservices@miele.com.hk
Website: www.miele.hk

India

Miele India Pvt. Ltd.
Ground Floor
Copia Corporate Suites
Plot No. 9, Jasola
New Delhi - 110025
Tel: 011-46 900 000
Fax: 011-46 900 001
E-mail: customercare@miele.in
Internet: www.miele.in

Ireland

Miele Ireland Ltd.
2024 Bianconi Avenue
Citywest Business Campus
Dublin 24
Tel: (01) 461 07 10
Fax: (01) 461 07 97
E-Mail: info@miele.ie
Internet: www.miele.ie

Malaysia

Miele Sdn Bhd
Suite 12-2, Level 12
Menara Sapura Kencana
Petroleum
Solaris Dutamas No. 1
Jalan Dutamas 1
50480 Kuala Lumpur, Malaysia
Phone: +603-6209-0288
Fax: +603-6205-3768

New Zealand

Miele New Zealand Limited
IRD 98 463 631
Level 2, 10 College Hill
Freemans Bay, Auckland 1011
New Zealand
Tel: 0800 464 353
Internet: www.miele.co.nz

Singapore

Miele Pte. Ltd.
163 Penang Road
04 - 03 Winsland House II
Singapore 238463
Tel: +65 6735 1191
Fax: +65 6735 1161
E-Mail: info@miele.com.sg
Internet: www.miele.sg

South Africa

Miele (Pty) Ltd
63 Peter Place, Bryanston 2194
P.O. Box 69434, Bryanston 2021
Tel: (011) 875 9000
Fax: (011) 875 9035
E-mail: info@miele.co.za
Internet: www.miele.co.za

Taiwan

K.E. & Kingstone Co., Ltd.
6th Fl., No. 120, Sec. 2
Jianguo N. Rd.
Taipei, Taiwan
TEL: +886 2 2502-7256
FAX: +886 2 2502-3077
E-mail: kenk@kenk.com.tw
Website:
www.kenk.com.tw/ke/miele

Thailand

BHIRAJ TOWER at EmQuartier
43rd Floor Unit 4301-4303
689 Sukhumvit Road
North Klontong Sub-District
Vadhana District
Bangkok 10110, Thailand

United Arab Emirates

Miele Appliances Ltd.
Gold & Diamond Park
Office No. 6-217
Sheikh Zayed Road
P.O. Box 11 47 82 - Dubai
Tel. +971 4 3044 999
Fax. +971 4 3418 852
800-MIELE (64353)
E-Mail: info@miele.ae
Website: www.miele.ae

Manufacturer: Miele & Cie. KG, Carl-Miele-Straße 29, 33332 Gütersloh, Germany

DG 7440

en-GB

M.-Nr. 11 244 840 / 00