

Contents

1	Instructions	46
1.1	General safety instructions	46
1.2	Manufacturer liability	47
1.3	Appliance purpose	47
1.4	Disposal	47
1.5	Identification plate	48
1.6	This user manual	48
1.7	How to read the user manual	48
2	Description	49
2.1	General Description	49
2.2	Cooking hob	50
2.3	Control panel	50
2.4	Other parts	52
2.5	Available accessories	52
3	Use	54
3.1	Instructions	54
3.2	First use	55
3.3	Using the accessories	55
3.4	Using the hob	57
3.5	Using the ovens	58
3.6	Cooking advice	60
3.7	Programmer clock	62
4	Cleaning and maintenance	66
4.1	Instructions	66
4.2	Cleaning the appliance	66
4.3	Removing the door of the auxiliary oven	67
4.4	Cleaning the door glazing	68
4.5	Removing the internal glass panes	68
4.6	Cleaning the inside of the oven	70
4.7	Vapor Clean: assisted oven cleaning	71
4.8	Extraordinary maintenance	73
5	Installation	74
5.1	Gas connection	74
5.2	Adaptation to different types of gas	77
5.3	Electrical connection	82
5.4	Positioning	83

We advise you to read this manual carefully, which contains all the instructions for maintaining the appliance's aesthetic and functional qualities.

For further information on the product: www.smeg.com



Instructions

1 Instructions

1.1 General safety instructions

Risk of personal injury

- During use the appliance and its accessible parts become very hot.
- Never touch the heating elements during use.
- Keep children under eight years of age at a safe distance if they are not constantly supervised.
- Children must never play with the appliance.
- Never rest metallic objects such as knives, forks, spoons and lids on the appliance during use.
- Switch the appliance off immediately after use.
- Never try to put out a fire or flames with water: turn off the appliance and smother the flames with a fire blanket or other appropriate cover.
- The appliance must never be cleaned by unsupervised children.
- Have qualified personnel carry out installation and assistance interventions according to the standards in force.
- Do not modify this appliance.

- Do not insert pointed metal objects (cutlery or utensils) into the slots in the appliance.
- Do not try to repair the appliance yourself or without the intervention of a qualified technician.
- If the power supply cable is damaged, contact technical support immediately and they will replace it.

Risk of damaging the appliance

- Do not use abrasive or corrosive detergents on glass parts (e.g. powder products, stain removers and metallic sponges).
- Use wooden or plastic utensils.
- Do not seat on the appliance.
- Do not use steam jets for cleaning the appliance.
- Do not obstruct ventilation openings and heat dispersal slots.
- Never leave the appliance unattended during cooking operations where fats or oils could be released.
- Never leave objects on the cooking surface.
- Do not use the appliance to heat rooms for any reason.



For this appliance

- Ensure that the appliance is switched off before replacing the bulb.
- Do not rest any weight or sit on the open door of the appliance.
- Take care that no objects are stuck in the doors.

1.2 Manufacturer liability

The manufacturer declines all liability for damage to persons or property caused by:

- use of the appliance other than the one envisaged;
- non-observance of the user manual provisions;
- tampering with any part of the appliance;
- use of non-original spare parts.

1.3 Appliance purpose

- This appliance is intended for cooking food in the home environment. Every other use is considered improper.
- This appliance may be used by children aged at least 8 and by people of reduced physical and mental capacity, or lacking in experience in the use of electrical appliances, as long they are supervised or instructed by adults who are responsible for their safety.
- The appliance is not designed to operate with external timers or with remote-control systems.

1.4 Disposal



This appliance must be disposed of separately from other waste (Directives 2002/95/EC, 2002/96/EC, 2003/108/EC). The appliance does not contain substances in quantities sufficient to be considered hazardous to health and the environment, in accordance with current European directives.

To dispose of the appliance:

- Cut the power supply cable and remove it along with the plug.



Power voltage

Danger of electrocution

- Disconnect the main power supply.
- Disconnect the power cable from the electrical system.
- Consign the appliance to the appropriate selective collection centres for electrical and electronic equipment waste, or deliver it back to the retailer when purchasing an equivalent product, on a one for one basis.



Instructions

Our appliances are packed in non-polluting and recyclable materials.

- Consign the packing materials to the appropriate selective collection centres.



Plastic packaging Danger of suffocation

- Do not leave the packaging or any part of it unattended.
- Do not let children play with the packaging plastic bags.

1.5 Identification plate

The identification plate bears the technical data, serial number and brand name of the appliance. Do not remove the identification plate for any reason.

1.6 This user manual

This user manual is an integral part of the appliance and must therefore be kept in its entirety and in an accessible place for the whole working life of the appliance.

Read this user manual carefully before using the appliance.

1.7 How to read the user manual

This user manual uses the following reading conventions:

Instructions



General information on this user manual, on safety and final disposal.

Description



Description of the appliance and its accessories.

Use



Information on the use of the appliance and its accessories, cooking advice.

Cleaning and maintenance



Information for proper cleaning and maintenance of the appliance.

Installation



Information for the qualified technician: installation, operation and inspection.



Safety instructions



Information



Advice

1. Use instruction sequence.

- Single use instruction.



2 Description

2.1 General Description

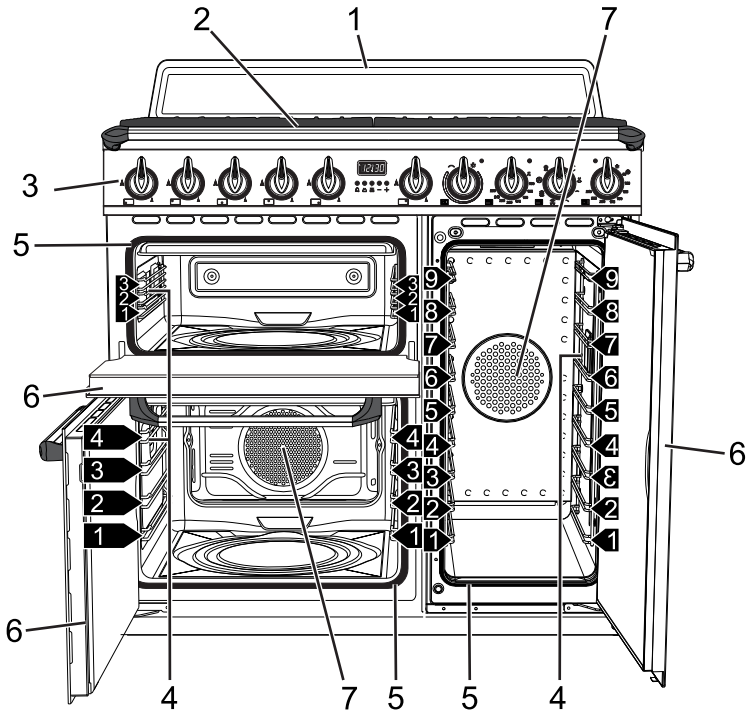

- 1 Backguard
- 2 Cooking hob
- 3 Control panel
- 4 Oven light
- 5 Seal

6 Door

7 Fan

1,2,3... Rack/tray support frame shelf



Description

2.2 Cooking hob

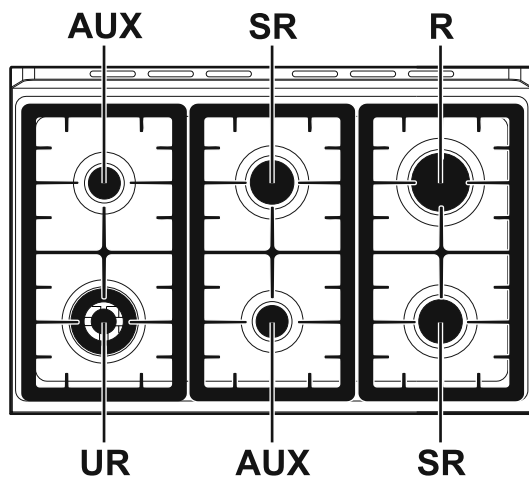

AUX = Auxiliary

SR = Semi-rapid

R = Rapid

UR = Ultra-rapid

2.3 Control panel

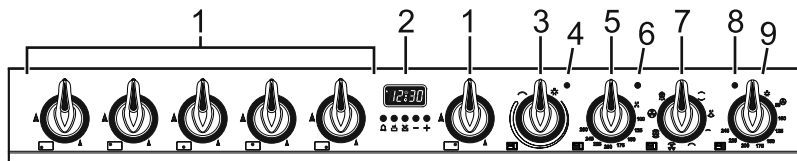

Hob burner knobs (1)

Useful for lighting and adjusting the hob burners.

Press and turn the knobs anti-clockwise to the value to light the relative burners. Turn the knobs to the zone between the maximum and minimum setting to adjust the flame.

Return the knobs to the position to turn off the burners.

Programmer clock (2)

Useful for displaying the current time, setting programmed cooking operations and programming the minute minder timer.

Auxiliary oven variable grill knob (3)

It turns on the light inside the oven or starts the grill heating element to a temperature ranging from a minimum of 50°C to a maximum of 245°C.



Auxiliary oven variable grill indicator light (4)

The indicator light comes on to indicate that the auxiliary oven is heating up. It turns off as soon as it reaches the set temperature. It flashes regularly to indicate that the temperature set inside the oven is kept constant.

Lower multifunction oven temperature knob (5)

This knob allows you to select the cooking temperature and the Vapor Clean temperature.

Turn the knob clockwise to the required value, between the minimum and maximum setting.

Lower multifunction oven indicator light (6)

The indicator light comes on to indicate that the oven is heating up. It turns off as soon as it reaches the set temperature. It flashes regularly to indicate that the temperature set inside the oven is kept constant.

Lower multifunction oven function knob (7)

The oven's various functions are suitable for different cooking modes. After selecting the required function, set the cooking temperature using the temperature knob.

Side oven indicator light (8)

The indicator light comes on to indicate that the oven is heating up. It turns off as soon as it reaches the set temperature. It flashes regularly to indicate that the temperature set inside the oven is kept constant.

Side oven function knob (9)

It turns on the light inside the oven or starts the circulaire heating element to a temperature ranging from a minimum of 50°C to a maximum of 245°C.



Description

2.4 Other parts

Shelves

The appliance features shelves for positioning trays and racks at different heights. The insertion heights are indicated from the bottom upwards (see 2.1 General Description).

Cooling fan

The fan cools the ovens and comes into operation during cooking.

The fan causes a steady outflow of air that exits from the rear of the appliance and which may continue for a brief period of time even after the appliance has been turned off.

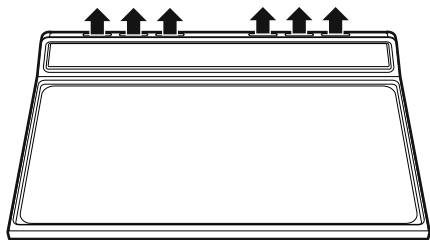

Interior lighting

The internal light of the ovens comes on when any function is selected.

2.5 Available accessories



Some models are not provided with all accessories.

Rack

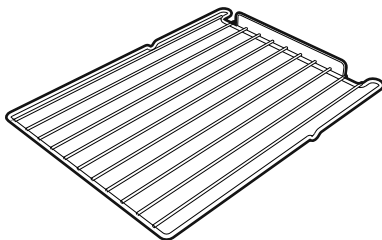
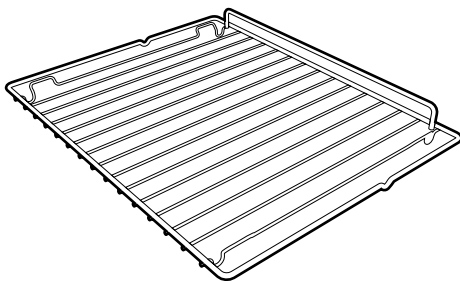

Useful for supporting containers with food during cooking.

Tray rack

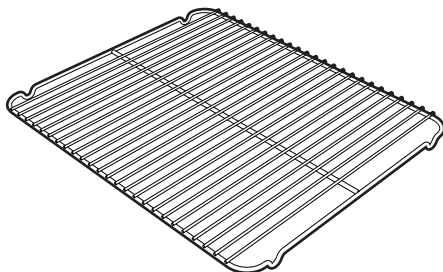

To be placed over the top of the oven tray; for cooking foods which may drip.



Oven tray

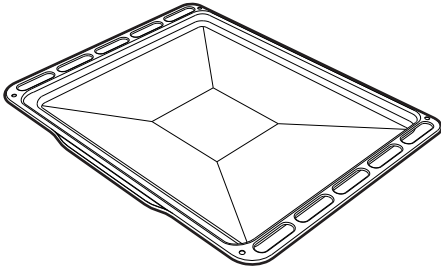

Useful for collecting fat from foods placed on the rack above.

Deep tray

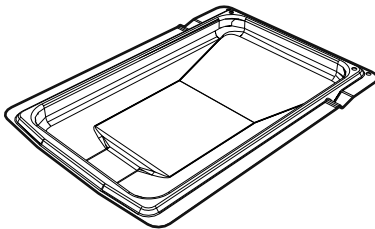
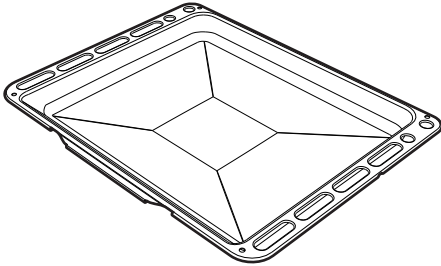

Useful for collecting fat from foods placed on the rack above and for cooking pies, pizzas and baked desserts.

Plate rack

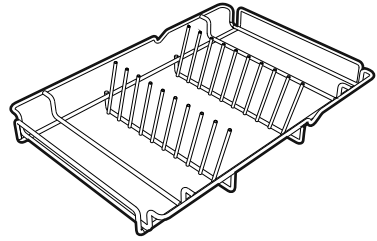

To be used for warming plates.

Reduction pan stand

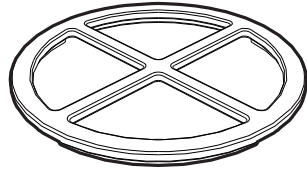

Useful when using small cookware.

WOK reduction pan stand

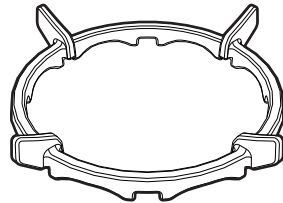

Useful when using a wok.



Use

3 Use

3.1 Instructions



High temperature inside the oven during use

Danger of burns

- Keep the oven door closed during cooking.
- Protect your hands wearing heat resistant gloves when moving food inside the oven.
- Do not touch the heating elements inside the oven.
- Do not pour water directly onto very hot trays.
- Do not allow children younger than 8 years old to come near the appliance when in operation.
- If you need to move food or at the end of cooking, open the door 5 cm for a few seconds, let the steam come out, then open it fully.



High temperature inside the storage compartment

Danger of burns

- Do not open the storage compartment when the oven is on and still hot.
- The items inside the storage compartment could be very hot after using the oven.



Improper use

Danger of burns

- Make sure that the flame-spreader crowns are correctly positioned in their housings with their respective burner caps.
- Oils and fat could catch fire if overheated. Be very careful.



High temperature inside the oven during use

Danger of fire or explosion

- Do not spray any spray products near the oven.
- Do not use or leave flammable materials near the oven or the storage compartment.
- Do not use plastic kitchenware or containers when cooking food.
- Do not put sealed tins or containers in the oven.
- Do not leave the oven unattended during cooking operations where fats or oils could be released.
- Remove all trays and racks which are not required during cooking.



Improper use Risk of damage to surfaces

- Do not cover the bottom of the oven cavity with aluminium or tin foil sheets.
- If you wish to use greaseproof paper, place it so that it will not interfere with the hot air circulation inside the oven.
- Do not place pans or trays directly on the bottom of the oven cavity.
- Do not use the open door to rest pans or trays on the internal glass pane.
- Do not pour water directly onto very hot trays.
- Make sure that the flame-spreader crowns are correctly positioned in their housings with their respective burner caps.
- The cooking vessels or griddle plates should be placed inside the perimeter of the hob.
- All pans must have smooth, flat bottoms.
- If any liquid does boil over or spill, remove the excess from the hob.

3.2 First use

1. Remove any protective film from the outside or inside of the appliance, including accessories.
2. Remove any labels (apart from the technical data plate) from the accessories and from the cooking compartments.
3. Remove all the accessories from the appliance and clean them (see 4 Cleaning and maintenance). Heat the empty ovens at the maximum temperature to burn off any residues left by the manufacturing process.

3.3 Using the accessories

Racks and trays

Racks and trays have to be inserted into the side guides until they come to a complete stop.

- The mechanical safety locks that prevent the rack from being taken out accidentally have to face downwards and towards the oven back.

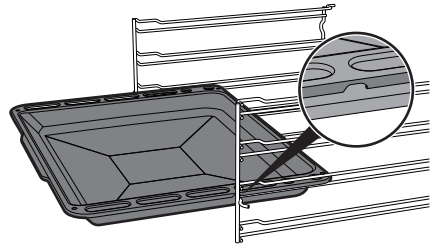
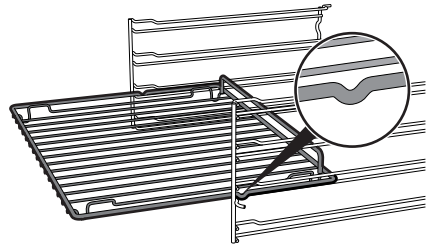

Gently insert racks and trays into the oven until they come to a stop.



Clean the trays before using them for the first time to remove any residues left by the manufacturing process.



Use

Tray rack

The tray rack has to be inserted into the tray. In this way fat can be collected separately from the food which is being cooked.

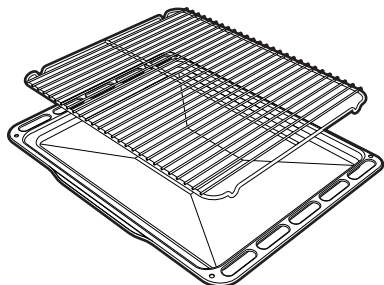

Reduction pan stands

The reduction pan stands have to be placed on the hob grids. Make sure they are properly placed.

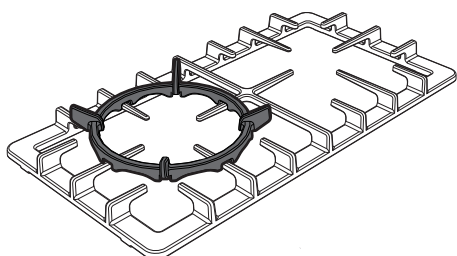
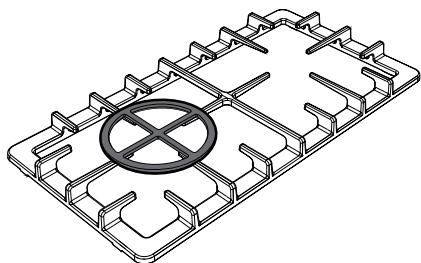
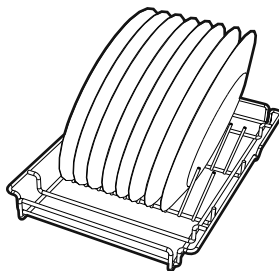

Plate rack

1. Insert the plate rack without plates in the first shelf of the side oven.
2. Position the plates as shown in the figure.



3. Heat the oven to a temperature no greater than 50°C for no more than 15 minutes.
4. After heating, extract the support slightly, leaving it on the rails.
5. Ensure that the support is stable and balanced, then remove the plates.



Use oven gloves when handling hot plates.



3.4 Using the hob

All the appliance's control and monitoring devices are located together on the front panel. The burner controlled by each knob is shown next to the knob. The appliance is equipped with an electronic ignition device. Simply press the knob and turn it anti-clockwise to the maximum flame symbol, until the burner lights. If the burner does not light in the first 15 seconds, turn the knob to  and wait 60 seconds before trying again. After lighting, keep the knob pressed in for a few seconds to allow the thermocouple to heat up. The burner may go out when the knob is released: in this case, the thermocouple has not heated up sufficiently. Wait a few moments and repeat the operation. Keep the knob pressed in longer.



In case of an accidental switching off, a safety device will be tripped, cutting off the gas supply, even if the gas tap is open. Return the knob to  and wait at least 60 seconds before lighting it again.

Correct positioning of the flame-spreader crowns and burner caps

Before lighting the hob burners, make sure that the flame-spreader crowns are correctly positioned in their housings with their respective burner caps. Make sure that the holes in the flame-spreader crowns are aligned with the igniters and thermocouples (A).

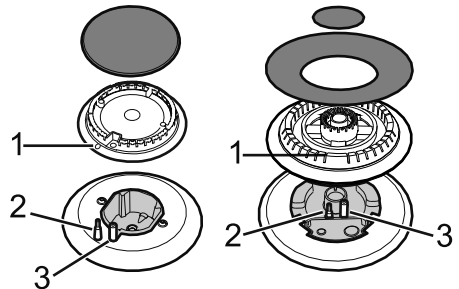

Practical tips for using the hob

For better burner efficiency and to minimise gas consumption, use pans with lids and of suitable size for the burner, so that flames do not reach up the sides of the pan. Once the contents come to the boil, turn down the flame far enough to ensure that the liquid does not boil over.



Cookware diameters:

- Auxiliary: 12 - 14 cm.
- Semi-rapid: 16 - 24 cm.
- Rapid: 18 - 26 cm.
- Ultra-rapid: 18 - 28 cm.



3.5 Using the ovens

Switching on the multifunction oven



To switch on the multifunction oven:

1. Select the cooking function using the function knob.
2. Select the temperature using the temperature knob.

Opening and closing the doors of the multifunction/side ovens

The multifunction and side ovens are equipped with a swing door. To open, pull the door handle towards you. To close, push the doors until you hear a mechanical "click".

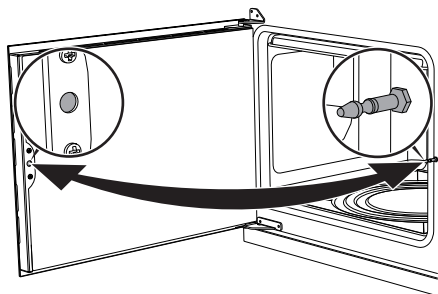

Switching on the auxiliary oven



To switch on the auxiliary oven:

- Select the temperature using the variable grill knob. The temperature ranges indicatively from a minimum of 50°C and a maximum of 300°C.



The doors are not held in place when open and may tend to reclose. During use, pay attention not to come into contact with the internal glass pane to prevent burns.



Over time the swing doors might get difficult to open and close. Grease the hinges.



Functions list



ECO

Depending on the function it is combined with, this ensures the greatest possible energy savings during cooking.



Static

As the heat comes from above and below at the same time, this system is particularly suitable for certain types of food. Traditional cooking, also known as static cooking, is suitable for cooking just one dish at a time. Perfect for all types of roasts, bread and cakes and in any case particularly suitable for fatty meats such as goose and duck.



Lower element

The heat coming just from the bottom allows you to complete the cooking of foods that require a higher bottom temperature, without affecting their browning. Perfect for cakes, pies, tarts and pizzas.



Small grill

Using only the heat released from the central element, this function allows you to grill small portions of meat and fish for making kebabs, toasted sandwiches and any types of grilled vegetable side dishes.



Grill

The heat coming from the grill element gives perfect grilling results above all for thin and medium thickness meat and in combination with the rotisserie (where fitted) gives the food an even browning at the end of cooking. Perfect for sausages, spare ribs and bacon. This function enables large quantities of food, particularly meat, to be grilled evenly.



Fan with grill

The air produced by the fan softens the strong heatwave generated by the grill, grilling perfectly even very thick foods. Perfect for large cuts of meat (e.g. shin of pork).



Fan assisted

The operation of the fan, combined with traditional cooking, ensures consistent cooking even with complex recipes. Perfect for biscuits and cakes, even when simultaneously cooked on several levels. (For multiple-level cooking, we recommend using the 2nd and 4th runners.)



Turbo

The combination of fan assisted cooking and traditional cooking allows different foods to be cooked on several levels extremely quickly and efficiently, without odours and flavours mingling. Perfect for large volumes that call for intense cooking.



Fan + circulaire

The combination of the fan and the circulaire heating element (incorporated in the rear of the oven) allows you to cook different foods on several levels, as long as they need the same temperatures and same type of cooking. Hot air circulation ensures instant and even distribution of heat. It will be possible, for instance, to cook fish, vegetables and biscuits simultaneously (on different levels) without odours and flavours mingling.



Rapid defrost

Rapid defrost is helped by the activation of a fan to ensure uniform distribution of room temperature air inside the oven. Perfect for any type of food.

3.6 Cooking advice

General advice

- Use a fan assisted function to achieve consistent cooking at several levels.
- It is not possible to shorten cooking times by increasing the temperature (the food could be overcooked on the outside and undercooked on the inside).

Advice for cooking meat

- Cooking times vary according to the thickness and quality of the food and to consumer taste.
- Use a meat thermometer when roasting meat, or simply press on the roast with a spoon. If it is hard, it is ready; if not, it needs another few minutes cooking.

Advice for cooking with the Grill and the Fan with grill

- Meat can be grilled even when it is put into the cold oven or into the preheated oven if you wish to change the effect of the cooking.
- With the Fan with grill function, we recommend that you preheat the oven before grilling.
- We recommend placing the food at the centre of the rack.
- With the Grill function, we recommend that you turn the temperature knob to the maximum value corresponding to the  symbol (where present) to optimise cooking.
- Foods should be seasoned before cooking. Foods should also be coated with oil or melted butter before cooking.



- Use the oven tray on the first bottom shelf to collect fluids produced by grilling.
- Grilling processes should never last more than 60 minutes using multifunction ovens, 30 minutes inside the auxiliary oven.

Advice for cooking desserts/pastries and biscuits

- Use dark metal moulds: they help to absorb the heat better.
- The temperature and the cooking time depend on the quality and consistency of the dough.
- To check whether the dessert is cooked right through: at the end of the cooking time, put a toothpick into the highest point of the dessert. If the dough does not stick to the toothpick, the dessert is cooked.
- If the dessert collapses when it comes out of the oven, on the next occasion reduce the set temperature by about 10°C, selecting a longer cooking time if necessary.
- While cooking desserts or vegetables, excessive condensation may form on the glass. In order to avoid this, open the door very carefully a couple of times while cooking.

Advice for defrosting and proving

- Place frozen foods without their packaging in a lidless container on the first shelf of the oven.
- Avoid overlapping the food.
- To defrost meat, use the rack placed on the second level and a tray on the first level. In this way, the liquid from the defrosting food drains away from the food.
- The most delicate parts can be covered with aluminium foil.
- For successful proving, a container of water should be placed in the bottom of the oven.

To save energy

- Stop cooking a few minutes before the time normally used. Cooking will continue for the remaining minutes with the heat which has accumulated inside the oven.
- Reduce any opening of the door to a minimum to avoid heat dispersal.
- Keep the inside of the appliance clean at all times.



3.7 Programmer clock

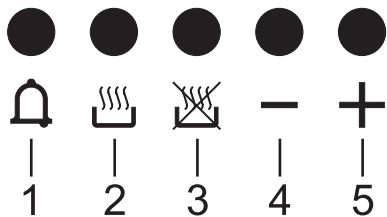

- 1 Minute minder timer key
- 2 Cooking duration key
- 3 End of cooking key
- 4 Value decrease key
- 5 Value increase key

Setting the time

i If the time is not set, the oven will not switch on.

On the first use, or after a power failure, the digits **A 0:00** will be flashing on the appliance's display.

1. Press the and keys at the same time. The dot between the hours and the minutes flashes.
2. The time can be set using or . Keep the key pressed in to increase or decrease rapidly.
3. Press the key or wait 5 seconds. The dot between the hours and the minutes stops flashing.
4. The symbol on the display indicates that the appliance is ready to start cooking.

Timed cooking

i Timed cooking is the function which allows a cooking operation to be started and then ended after a specific length of time set by the user.











1. After selecting a cooking function and temperature, press key . The display will show the digits **A 0:00** and the symbol displayed between the hours and the minutes.
2. Use the key or to set the required minutes.
3. Wait approx. 5 seconds without pressing any key in order for the function to

i The programmer clock controls solely the multifunction oven at the bottom left and has no control over the other ovens.

i Please make sure the programmer clock shows the cooking duration symbol , otherwise the oven will not switch on.

Press keys and at the same time to reset the programmer clock.



- activate. The current time and the symbols **A** and  will appear on the display.
- At the end of cooking the heating elements will be deactivated. On the display, symbol  turns off, symbol **A** flashes and the buzzer sounds.
 - To turn off the buzzer just press any key of the programmer clock.
 - Press keys  and  at the same time to reset the programmer clock.
 - Use the  or  key to set the required minutes.
 - Wait approx. 5 seconds without pressing any key in order for the function to activate. The current time and the symbols **A** and  will appear on the display.
 - At the end of cooking the heating elements will be deactivated. On the display, symbol  turns off, symbol **A** flashes and the buzzer sounds.
 - To turn off the buzzer just press any key of the programmer clock.
 - Press keys  and  at the same time to reset the programmer clock.





It is not possible to set a cooking time of more than 10 hours.





After the setting, to display the cooking time left press the  key.



To reset the set program, press keys  and  at the same time and switch off the oven manually.



After the setting, to display the cooking time left press the  key. To display the end of cooking time, press the  key.

Programmed cooking



Programmed cooking is the function which allows a cooking operation to be started at a set time and then ended after a specific length of time set by the user.

- Set the cooking time as described in the previous point "Timed cooking".
- Press  key. The sum of the current time plus the pre-set cooking duration will appear on the display.



Minute minder timer



The minute minder timer does not stop the cooking but rather informs the user when the set time has run out.

The minute minder timer can be activated at any time.

1. Press key. The display will show the digits and the indicator light flashing between the hours and the minutes.
2. Use the or key to set the required minutes.
3. Wait approx. 5 seconds without pressing any key to finish setting the minute minder. The current time and the symbols and appear on the display.



It is not possible to set a cooking time of more than 24 hours.



After the minute minder timer has been programmed, the display will go back to showing the current time; to display the remaining time, press .

Adjusting the buzzer volume

The buzzer volume can be set to 3 different levels. When the buzzer is in operation, press to change the setting.

Deleting the set data

Press keys and at the same time to reset the programs set.

Then switch off the oven manually if cooking is in progress.



Cooking information table

Food	Weight (Kg)	Function	Runner position from the bottom	Temperature (°C)	Time (minutes)	
Lasagne	3	Static	1 or 2	220 - 230	40 - 50	
Pasta bake	2.5	Static	1 or 2	220 - 230	40	
Roast veal	1	Circulaire	2	180 - 190	70 - 80	
Pork loin	1	Circulaire	2	180 - 190	70 - 80	
Pork shoulder	1	Fan assisted	2	180 - 190	90 - 100	
Roast rabbit	1	Circulaire	2	180 - 190	70 - 80	
Turkey breast	1	Fan assisted	2	180 - 190	110 - 120	
Roast pork neck	1	Fan assisted	2	180 - 190	190 - 210	
Roast chicken	1	Fan assisted	2	190 - 200	60 - 70	
					1 st surface	2 nd surface
Pork chops		Fan with grill	4	250	7 - 9	5 - 7
Pork fillet		Grill	3	250	9 - 11	5 - 9
Beef fillet		Grill	3	250	9 - 11	9 - 11
Liver slices		Fan with grill	4	250	2 - 3	2 - 3
Sausages		Fan with grill	3	250	7 - 9	5 - 6
Meatballs		Grill	3	250	7 - 9	5 - 6
Salmon trout	0.7	Circulaire	2	160 - 170	35 - 40	
Pizza		Fan assisted	1	250	6 - 10	
Bread		Circulaire	1	190 - 200	25 - 30	
Focaccia		Fan assisted	1	180 - 190	15 - 20	
Bundt cake		Circulaire	2	160	55 - 60	
Tart		Circulaire	2	160	30 - 35	
Short pastry		Circulaire	1 or 2	160 - 170	20 - 25	
Jam tarts		Fan assisted	1 or 2	160 - 170	40 - 50	
Paradise cake		Circulaire/Static	2	170	50 - 60	
Profiteroles		Fan assisted	2	150 - 160	40 - 50	
Sponge cake		Circulaire	2	150 - 160	45 - 50	
Rice pudding		Circulaire/Static	2	160 - 170	50 - 60	
Brioche		Circulaire	2	160	25 - 30	
Short pastry biscuits		Fan assisted	1-3	160 - 170	16 - 20	

The times indicated in the table do not include preheating times and are provided as a guide only.



Cleaning and maintenance

4 Cleaning and maintenance

4.1 Instructions



Improper use

Risk of damage to surfaces

- Do not use steam jets for cleaning the appliance.
- Do not use cleaning products containing chlorine, ammonia or bleach on steel parts or parts with metallic finishes on the surface (e.g. anodizing, nickel- or chromium-plating).
- Do not use abrasive or corrosive detergents on glass parts (e.g. powder products, stain removers and metallic sponges).
- Do not use rough or abrasive materials or sharp metal scrapers.
- Do not wash the removable components such as the hob pan stands, flame-spreader crowns and burner caps in a dishwasher.

4.2 Cleaning the appliance

To keep the surfaces in good condition, they should be cleaned regularly after use. Let them cool first.

Ordinary daily cleaning

Always use only specific products that do not contain abrasives or chlorine-based acids.

Pour the product onto a damp cloth and wipe the surface, rinse thoroughly and dry with a soft cloth or a microfibre cloth.

Food stains or residues

Do not use metallic sponges or sharp scrapers as they will damage the surfaces.

Use ordinary non-abrasive products with the aid of wooden or plastic utensils if necessary. Rinse thoroughly and dry with a soft cloth or a microfibre cloth.

Do not allow residues of sugary foods (such as jam) to set inside the oven. If left to set for too long, they might damage the enamel lining of the oven.

Cooking hob grids

Remove the grids and clean them with lukewarm water and non-abrasive detergent. Make sure to remove any encrustations. Dry them thoroughly and return them to the hob.



Continuous contact between the grids and the flame can cause modifications to the enamel over time in those parts exposed to heat. This is a completely natural phenomenon which has no effect on the operation of this component.



Flame-spreader crowns and burner caps

For easier cleaning, the flame-spreader crowns and the burner caps can be removed. Wash them in hot water and non-abrasive detergent. Carefully remove any encrustation, then wait until they are perfectly dry. Refit the flame-spreader crowns making sure that they are correctly positioned in their housings with their respective burner caps.

Igniters and thermocouples

For correct operation the igniters and thermocouples must always be perfectly clean. Check them frequently and clean them with a damp cloth if necessary. Remove any dry residues with a wooden toothpick or a needle.

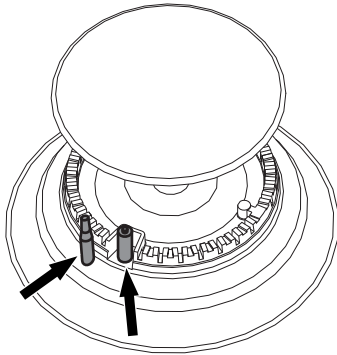

4.3 Removing the door of the auxiliary oven

For easier cleaning, the door can be removed and placed on a canvas.

To remove the door proceed as follows:

1. Open the door completely and insert two pins into the holes on the hinges indicated in the figure.

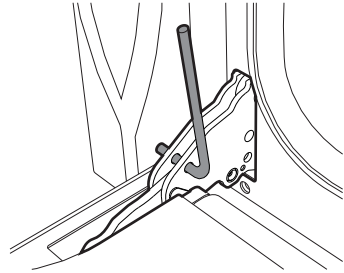

2. Grasp the door on both sides with both hands, lift it forming an angle of around 30° and remove it.

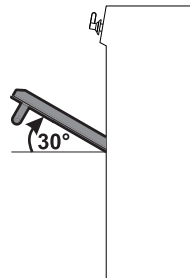



Cleaning and maintenance

3. To reassemble the door, put the hinges in the relevant slots in the oven, making sure that grooved sections **A** are resting completely in the slots. Lower the door and once it is in place remove the pins from the holes in the hinges.

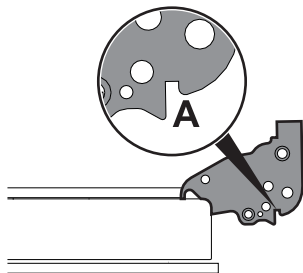

4.4 Cleaning the door glazing

The glass in the door should always be kept thoroughly clean. Use absorbent kitchen roll. In case of stubborn dirt, wash with a damp sponge and an ordinary detergent.



We recommend the use of cleaning products distributed by the manufacturer.

4.5 Removing the internal glass panes

For easier cleaning the door internal glass panes can be disassembled.

Multifunction oven doors

1. Remove the internal glass pane by pulling the top part gently, following the movement indicated by the arrows (1).

2. Then, pull the bottom part upwards (2). In this way, the 4 pins attached to the glass detach from their housings in the oven door.

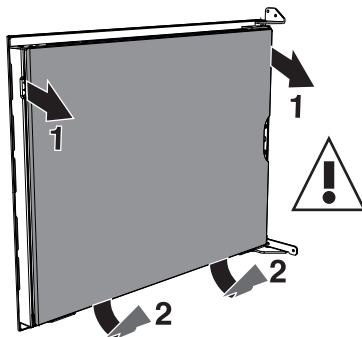

3. Hold the intermediate glass pane and unscrew the screw to remove the lower plate holding it in place.

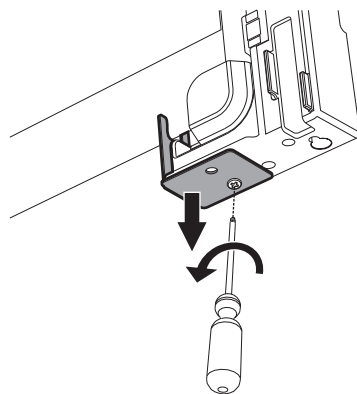

Improper use

Danger of cuts and glass crack

- Pay attention to the intermediate glass pane that could accidentally come out of its seat during this phase.



4. Remove the intermediate glass pane. First raise it upwards (1) and then remove it pulling it downwards (2).

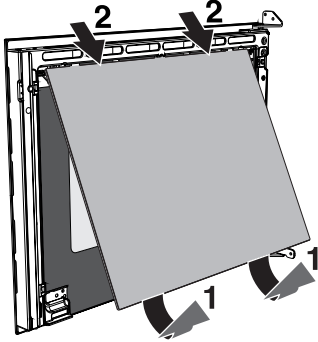

5. Clean the external glass pane and the panes previously removed. Use absorbent kitchen roll. In case of stubborn dirt, wash with a damp sponge and neutral detergent.

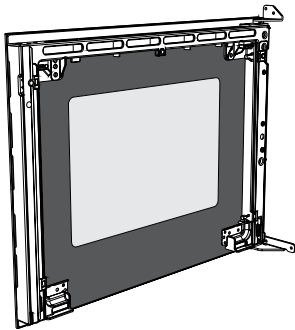

6. Refit the panes in the reverse order in which they were removed.

7. Reposition the internal glass pane. Take care to centre and insert the 4 pins into their housings in the oven door by applying slight pressure.

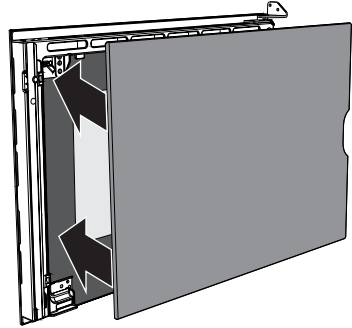

Auxiliary oven door

1. Remove the internal glass pane by pulling the rear part gently upwards, following the movement indicated by the arrows (1).
2. Then, pull the front part upwards (2). In this way, the 4 pins attached to the glass detach from their housings in the oven door.

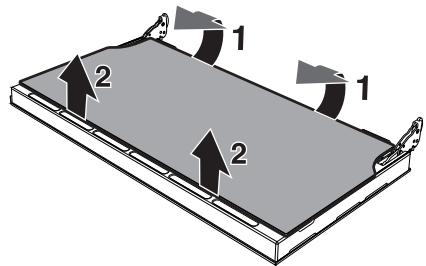



Cleaning and maintenance

3. Remove the intermediate glass pane by lifting it upwards.

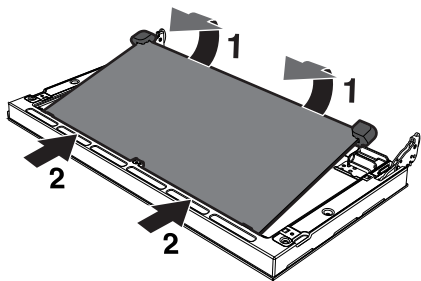

4. Clean the external glass pane and the panes previously removed. Use absorbent kitchen roll. In case of stubborn dirt, wash with a damp sponge and neutral detergent.

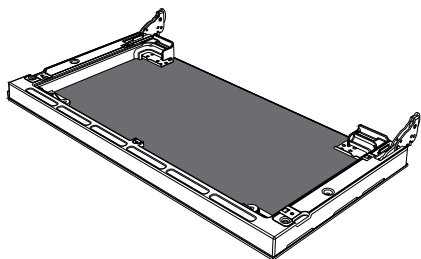

5. Refit the panes in the reverse order in which they were removed.
6. Reposition the internal glass pane. Take care to centre and insert the 4 pins into their housings in the oven door by applying slight pressure.

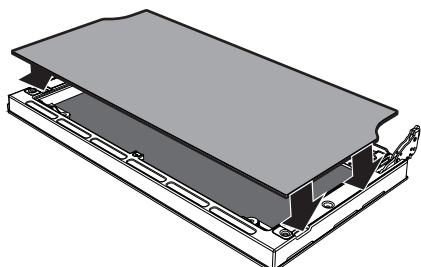

4.6 Cleaning the inside of the oven

For the best oven upkeep, clean it regularly after having allowed it to cool.

Take out all removable parts.



Clean the oven racks with warm water and non-abrasive detergent. Carefully rinse and dry damp parts.



The oven should be operated at the maximum temperature for about 15-20 minutes after the use of specific products, to burn off the residues left inside the oven.



For easier cleaning, remove the door.



Removing racks/trays support frames

Removing the guide frames enables the sides to be cleaned more easily. This operation should be performed each time the automatic cleaning cycle is used (on some models only).

To remove the guide frames: Pull the frame towards the inside of the oven to unhook it from its groove **A**, then slide it out of the seats **B** at the back.

When cleaning is complete, repeat the above procedures to put the guide frames back in.

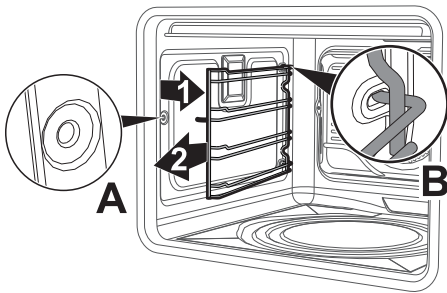

Removing the side oven racks/trays support frames

Pull the frame upwards to remove it from its side housings. Replace the frame correctly when you have finished cleaning.

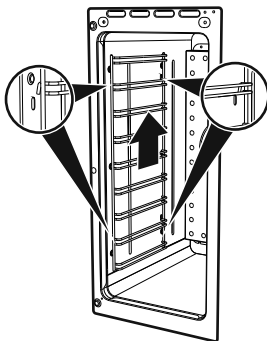

4.7 Vapor Clean: assisted oven cleaning



Vapor Clean is an assisted cleaning procedure which facilitates the removal of dirt. Thanks to this process, it is possible to clean the inside of the oven very easily. The dirt residues are softened by the heat and water vapour for easier removal afterwards.



Improper use
Risk of damage to surfaces

- Remove any food residues or large spills from previous cooking operations from the inside of the oven.
- Carry out assisted oven cleaning operations only when the oven is cold.

Preliminary operations

Before starting the Vapor Clean cleaning cycle:

- Completely remove all accessories from inside the oven. The upper guard can be left inside the oven.
- Pour approx. 40 cl of water onto the floor of the oven. Make sure it does not overflow out of the cavity.



Cleaning and maintenance

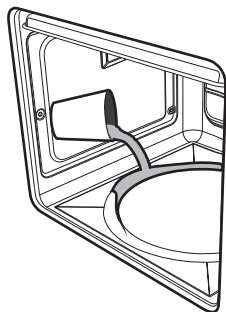

- Spray a water and washing up liquid solution inside the oven using a spray nozzle. Direct the spray against the side walls, upwards, downwards and towards the deflector.

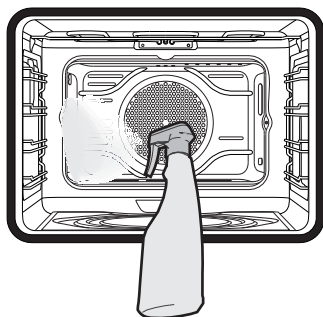



- Close the door.



We recommend spraying approx. 20 times at the most.

Vapor Clean setting

1. Turn the function knob to the  symbol and the temperature knob to the  symbol.
2. Set a cooking time of 18 minutes using the programmer clock.
3. At the end of the cooking time, the timer will switch the oven heating elements off and the buzzer will start to sound.

End of the Vapor Clean cycle

4. Open the door and wipe away the less stubborn dirt with a microfibre cloth.
5. Use an anti-scratch sponge with brass filaments on tougher encrustations.
6. In case of grease residues use specific oven cleaning products.
7. Remove the water left inside the oven.

For improved hygiene and to avoid food being affected by any unpleasant odours, we recommend that the oven is dried using a fan assisted function at 160°C for approximately 10 minutes.



We recommend wearing rubber gloves for these operations.



For easier manual cleaning of the parts difficult to reach, we recommend removing the door.



4.8 Extraordinary maintenance



Live parts
Danger of electrocution

- Disconnect the oven power supply.

Replacing the internal light bulb

1. Completely remove all accessories from inside the oven.
2. Remove the racks/trays support frames.
3. Remove the bulb cover using a tool (e.g. a screwdriver).

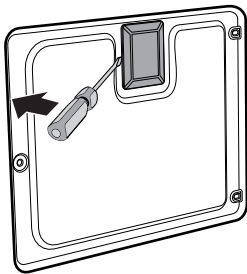

4. Slide out and remove the lamp.

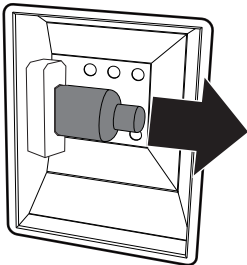

Do not touch the halogen lamp directly with your fingers, but wrap it in an insulating material.

5. Replace the lamp with one of the same type (40W).
6. Refit the cover correctly, so that the moulded part of the glass is facing the door.
7. Press the cover completely down so that it attaches perfectly to the bulb support.

Removing the seal of the auxiliary oven

To permit thorough cleaning of the oven, the door seal can be removed. There are hooks on all four sides to attach it to the edge of the oven. Pull the edges of the seal outwards to detach the hooks.

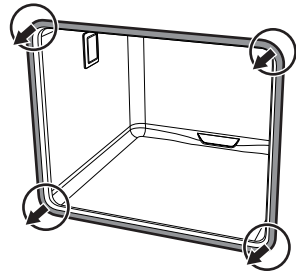

To keep the seals clean, use a non-abrasive sponge and lukewarm water. Seals should be soft and elastic.



Installation

5 Installation

5.1 Gas connection



Gas leak
Danger of explosion

- After carrying out any operation, check that the tightening torque of gas connections is between 10 Nm and 15 Nm.
- If required, use a pressure regulator that complies with current regulations.
- At the end of the installation, check for any leaks with a soapy solution, never with a flame.
- Installation with flexible hose must be carried out so that the length of the piping does not exceed 2 metres when fully extended as regards flexible steel hoses and 1.5 metres in case of rubber hoses.
- The hoses should not come into contact with moving parts and should not be crushed in any way.

Connection with a rubber hose

Verify that all following conditions are met:

- the hose is fixed to the hose connection with safety clamps;
- no part of the hose is in contact with hot walls (max. 50 °C);
- the hose is not under traction or tension and has no kinks or twists;
- the hose is not in contact with sharp objects or sharp corners;
- if the hose is not perfectly airtight and leaks gas, do not try to repair it; replace it with a new hose.
- verify that the hose is not past its expiry date (serigraphed on the hose itself).

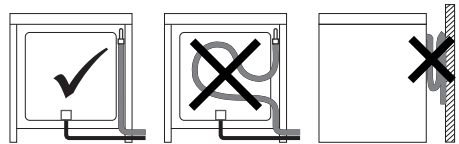

Make the connection to the gas mains using a rubber hose whose specifications comply with current standards (verify that the reference standard is stamped on the hose).

Carefully screw the hose connector **3** to the appliance's gas connector **1** ($\frac{1}{2}$ " thread ISO 228-1), placing the seal **2** between them. The hose connector **4** can also be screwed to the hose connector **3**, depending on the diameter of the gas hose used. After having tightened the hose connector(s), push the gas hose **6** onto the hose connector and secure it with the clamp

General information

Connection to the gas supply network can be made using a continuous wall flexible steel hose in compliance with the guidelines established by the standards in force. The appliance is preset for natural gas G20 (2H) at a pressure of 20 mbar. For supplying it with other types of gas, see chapter "5.2 Adaptation to different types of gas". The gas inlet connection is threaded $\frac{1}{2}$ " external gas (ISO 228-1).



5 that is compliant with the standard in force.

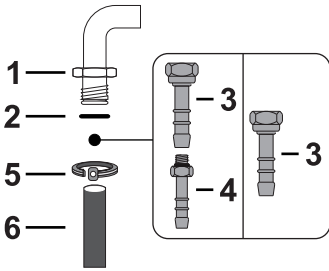

Connection with a flexible steel hose with bayonet fitting

Carry out the connection to the gas mains using a flexible steel hose with bayonet fitting compliant with B.S. 669. Apply insulating material to the thread of the gas hose connector **4** and then tighten the adapter **3**. Screw the assembly to the movable connector **1** of the appliance, placing the supplied seal **2** between them.

EN



Connection using a rubber hose complying with current standards is only permitted if the hose can be inspected along its entire length.



The inside diameter of the hose must be 8 mm for LPG and 13 mm for Natural gas and City gas.

Connection with a flexible steel hose

Make the connection to the gas mains using a continuous wall flexible steel hose whose specifications comply with the applicable standard.

Carefully screw the connector **3** to the gas connector **1** of the appliance, placing the seal **2** between them.

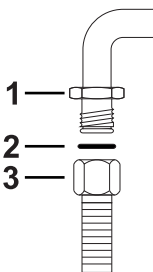
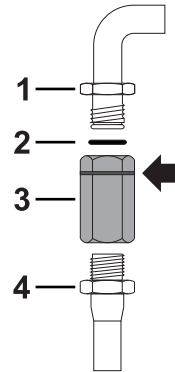



Installation

Connection with a flexible steel hose with conical fitting

Make the connection to the gas mains using a continuous wall flexible steel hose whose specifications comply with the applicable standard.

Carefully screw the hose connector **3** to the appliance's gas connector **1** ($\frac{1}{2}$ " thread ISO 228-1), placing the supplied seal **2** between them. Apply insulating material to the thread of the connector **3**, and then tighten the flexible steel hose **4** to the connector **3**.

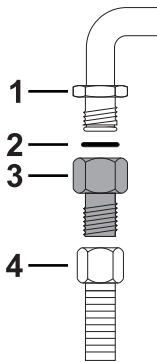

Connection to LPG

Use a pressure regulator and make the connection on the gas cylinder following the guidelines set out in the standards in force.

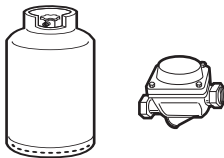

The supply pressure must comply with the values indicated in the table in "Gas types and Countries".

Room ventilation

The appliance should be installed in rooms that have a permanent air supply in accordance with the standards in force. The room where the appliance is installed must have enough air flow for the regular combustion of gas and the necessary air change in the room itself. The air vents, protected by grilles, must be the right size to comply with current regulations and positioned so that no part of them is obstructed, not even partially.

The room must be kept adequately ventilated in order to eliminate the heat and humidity produced by cooking: in particular, after prolonged use, you are recommended to open a window or to increase the speed of any fans.

Extraction of the combustion products

The combustion products may be extracted by means of hoods connected to a natural draught chimney whose efficiency is certain or via forced extraction. An efficient extraction system requires precision planning by a specialist qualified in this area and must comply with the positions and distances indicated by the applicable standards.



When the job is complete, the installer must issue a certificate of conformity.

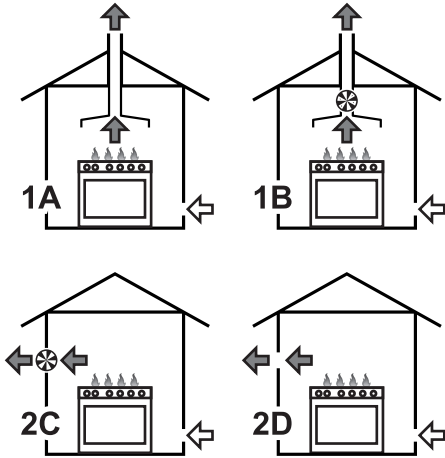

- 1 Extraction using a hood
- 2 Extraction without a hood

- A Single natural draught chimney
- B Single chimney with extractor fan
- C Directly outdoors with wall- or window-mounted extractor fan
- D Directly outdoors through wall

- Air
- Combustion products
- Extractor fan

5.2 Adaptation to different types of gas

i The appliance is preset for natural gas G20 at a pressure of 20 mbar.

In case of operation with other types of gas, the burner nozzles must be changed and the minimum flame adjusted on the gas taps.

Replacing nozzles

1. Remove the pan stands, burner caps and flame-spreader crowns to access the burner casings.
2. Replace the nozzles using a 7 mm spanner according to the gas to be used (see Burner and nozzle characteristics tables).

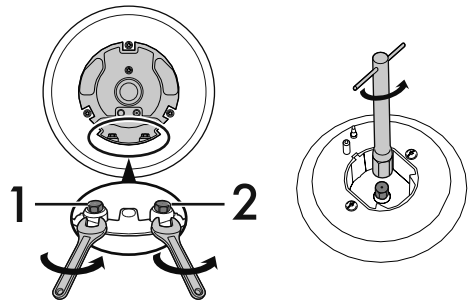

- 1. Internal nozzle
- 2. External nozzle

3. Replace the burners in the correct position.



Installation

Adjusting the minimum setting for natural or city gas

Light the burner and turn it to the minimum position. Extract the gas tap knob and turn the adjustment screw next to the tap rod (depending on the model) until the correct minimum flame is achieved.

Refit the knob and verify that the burner flame is stable. Turn the knob rapidly from the maximum to the minimum setting: the flame should not go out. Repeat the operation on all gas taps.

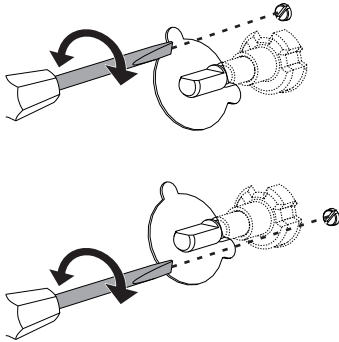

Adjusting the minimum setting for LPG

Tighten the screw located at the side of the tap rod clockwise all the way.



Following adjustment to a gas other than the one originally set in the factory, replace the gas setting label on the appliance with the one corresponding to the new gas. The label is inserted inside the nozzle pack (where present).

Lubricating the gas taps

Over time the gas taps may become difficult to turn and get blocked. Clean them internally and replace the lubrication grease.



Lubrication of the gas taps should be performed by a specialised technician.



Gas types and Countries

Gas types		IT	GB-IE	FR-BE	DE	AT	NL	ES	PT	SE	RU	DK	PL	HU
1 Natural Gas G20														
G20	20 mbar	•	•		•	•		•	•	•	•	•		
G20/25	20/25 mbar			•										
2 Natural Gas G20														
G20	25 mbar													•
3 Natural Gas G25														
G25	25 mbar						•							
4 Natural Gas G25.1														
G25.1	25 mbar													•
5 Natural Gas G25														
G25	20 mbar				•									
6 Natural Gas G27														
G27	20 mbar												•	
7 Natural Gas G2.350														
G2.350	13 mbar													•
8 LPG G30/31														
G30/31	28/37 mbar		•	•				•			•			
G30/31	30/37 mbar	•							•					
G30/31	30/30 mbar						•			•		•		
9 LPG G30/31														
G30/31	37 mbar													•
10 LPG G30/31														
G30/31	50 mbar				•	•								
11 City Gas G110														
G110	8 mbar	•								•		•		
12 City Gas G120														
G120	8 mbar									•				



Installation

Burner and nozzle characteristics tables

1 Natural Gas G20	AUX	SR	R	UR2 (int)+(ext)
Rated heating capacity (kW)	1.0	1.8	2.9	4.2
Nozzle diameter (1/100 mm)	72	97	115	75+135
Pre-chamber (printed on nozzle)	(X)	(Z)	(Y)	(H1)+(H3)
Reduced capacity (W)	400	500	800	1900
2 Natural Gas G20	AUX	SR	R	UR2 (int)+(ext)
Rated heating capacity (kW)	1.1	1.8	2.9	4.2
Nozzle diameter (1/100 mm)	72	94	115	75+125
Pre-chamber (printed on nozzle)	(X)	(Z)	(8)	(H1)+(H3)
Reduced capacity (W)	400	500	800	1900
3 Natural Gas G25	AUX	SR	R	UR2 (int)+(ext)
Rated heating capacity (kW)	1.0	1.8	3.0	4.2
Nozzle diameter (1/100 mm)	72	94	121	75+145
Pre-chamber (printed on nozzle)	(F1)	(Y)	(F2)	(H1)+(H3)
Reduced capacity (W)	400	500	800	1900
4 Natural Gas G25.1	AUX	SR	R	UR2 (int)+(ext)
Rated heating capacity (kW)	1.1	1.8	3.0	4.1
Nozzle diameter (1/100 mm)	77	100	134	75+138
Pre-chamber (printed on nozzle)	(F1)	(Y)	(F3)	(H1)+(F3)
Reduced capacity (W)	400	500	800	1900
6 Natural Gas G27	AUX	SR	R	UR2 (int)+(ext)
Rated heating capacity (kW)	1.0	1.8	2.9	4.1
Nozzle diameter (1/100 mm)	77	105	138	80+148
Pre-chamber (printed on nozzle)	(F1)	(Y)	(F3)	(H1)+(F3)
Reduced capacity (W)	400	500	800	1900
7 Natural Gas G2.350	AUX	SR	R	UR2 (int)+(ext)
Rated heating capacity (kW)	1.0	1.8	2.9	4.1
Nozzle diameter (1/100 mm)	94	120	165	100+190
Pre-chamber (printed on nozzle)	(Y)	(Y)	(F3)	(0)+(H3)
Reduced capacity (W)	400	500	800	1900
8 LPG G30/31	AUX	SR	R	UR2 (int)+(ext)
Rated heating capacity (kW)	1.0	1.8	2.9	4.1
Nozzle diameter (1/100 mm)	50	65	85	46+91
Reduced capacity (W)	400	500	800	1900
Rated capacity G30 (g/h)	73	131	211	305
Rated capacity G31 (g/h)	71	129	207	300
9 LPG G30/31	AUX	SR	R	UR2 (int)+(ext)
Rated heating capacity (kW)	1.1	1.8	2.9	4.2
Nozzle diameter (1/100 mm)	50	62	81	62+62
Pre-chamber (printed on nozzle)	-	-	-	-
Reduced capacity (W)	450	550	800	1900
Rated capacity G30 (g/h)	80	131	211	298
Rated capacity G31 (g/h)	79	129	207	293

Installation



10 LPG G30/31	AUX	SR	R	UR2 (int)+(ext)
Rated heating capacity (kW)	1.0	1.8	2.9	4.2
Nozzle diameter (1/100 mm)	43	58	70	43+70
Pre-chamber (printed on nozzle)	(H2)	(M)	(Y)	(H2)+(S1)
Reduced capacity (W)	400	500	850	1900
Rated capacity G30 (g/h)	73	131	211	305
Rated capacity G31 (g/h)	71	129	207	300
11 City Gas G110	AUX	SR	R	UR2 (int)+(ext)
Rated heating capacity (kW)	1.0	1.8	2.8	3.8
Nozzle diameter (1/100 mm)	145	185	260	140+320
Pre-chamber (printed on nozzle)	/8	/2	/3	-
Reduced capacity (W)	400	500	800	1400
12 City Gas G120	AUX	SR	R	UR2 (int)+(ext)
Rated heating capacity (kW)	1.0	1.8	2.8	3.9
Nozzle diameter (1/100 mm)	135	175	240	130+290
Pre-chamber (printed on nozzle)	/8	/1	/3	-
Reduced capacity (W)	400	500	800	1400

Nozzles which are not provided are available at Authorised Service Centres.



Installation

5.3 Electrical connection



**Power voltage
Danger of electrocution**

- Have the electrical connection performed by authorised technical personnel.
- Use personal protective equipment.
- The appliance must be connected to earth in compliance with electrical system safety standards.
- Disconnect the main power supply.
- Do not pull the cable to remove the plug.
- Use H05V2V2-F cables withstanding a temperature of at least 90°C.
- The tightening torque of the screws of the terminal supply wires must be 1.5 - 2 Nm.

General information

Check the grid characteristics against the data indicated on the plate.

The identification plate bearing the technical data, serial number and brand name is visibly positioned on the appliance. Do not remove this plate for any reason. Perform the ground connection using a wire that is 20 mm longer than the other wires.

The appliance can work in the following modes:

- **220-240 V 1N~**

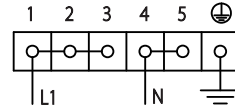

Use a **3 x 6 mm² three-core** cable.

- **380-415 V 2N~**

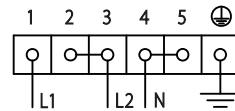

Use a **4 x 4 mm² four-core** cable.

- **380-415 V 3N~**

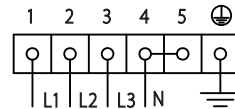

Use a **5 x 1.5 mm² five-core** cable.



The values indicated above refer to the cross-section of the internal conductor.



The aforementioned power cables are sized taking into account the coincidence factor (in compliance with standard EN 60335-2-6).



Fixed connection

Fit the power line with an omnipolar circuit breaker in compliance with installation regulations.

The circuit breaker should be located near the appliance and in an easily reachable position.

Connection with plug and socket

Make sure that the plug and socket are of the same type.

Avoid using adapters and shunts as these could cause overheating and a risk of burns.

5.4 Positioning



Heavy appliance
Danger of crush injuries

- Place the appliance into the piece of furniture with the aid of a second person.



Pressure on the open door
Risk of damages to the appliance

- Never use the oven door to lever the appliance into place when fitting.
- Avoid exerting too much pressure on the oven door when open.



Heat production during appliance operation
Risk of fire

- Veneers, adhesives or plastic coatings on adjacent furniture should be temperature-resistant (no less than 90°C).

General information

This appliance may be installed next to walls, one of which must be higher than the worktop, at a minimum distance of 50 mm from the side of the appliance, as shown in figures A and C relative to the installation classes.

Any wall units positioned above the worktop must be at a minimum distance of at least 750 mm. If a hood is installed above the hob, refer to the hood instruction manual to ensure the correct clearance is left.



Installation

Depending on the type of installation, this appliance belongs to classes:

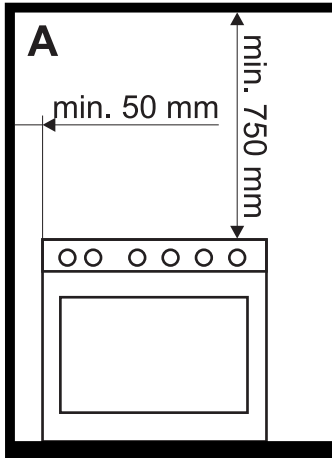

A - Class 1
(Free-standing appliance)

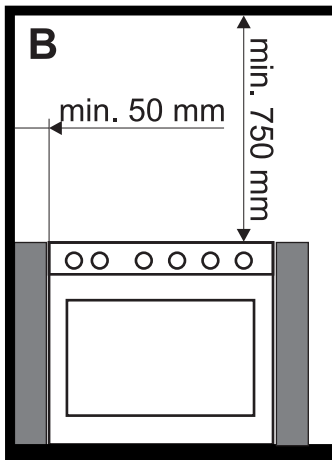

B - Class 2 subclass 1
(Built-in appliance)

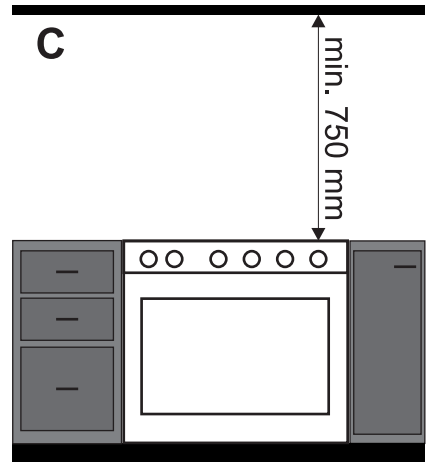

C - Class 2 subclass 1
(Built-in appliance)



The appliance must be installed by a qualified technician and according to the regulations in force.



Assembling the backguard

i The backguard provided is an integral part of the product; it must be fastened to the appliance prior to installation.

The backguard must always be positioned and secured correctly on the appliance.

1. Loosen the 6 screws on the back of the top (A) and unscrew the 2 screws (B) on the side part of the backguard.

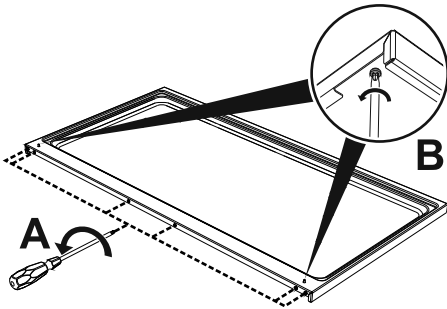

2. Place the backguard on the top. Align the 6 bottom slots of the backguard with the 6 screws on the back of the top that were previously loosened.
3. Tighten the 6 screws on the back of the hob (A) and tighten the 2 screws under the top (B) to secure the backguard.

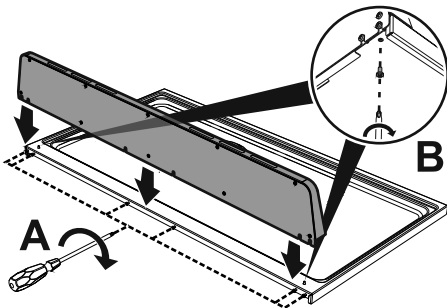

Mounting the toe skirt

i The toe skirt provided is an integral part of the product; it must be fastened to the appliance prior to installation.

The toe skirt must always be positioned and secured correctly on the appliance.

1. Place the toe skirt in the front bottom part of the appliance.
2. Screw the two side screws to fasten the toe skirt to the appliance.
3. Cover the holes of the toe skirt with the plugs provided.

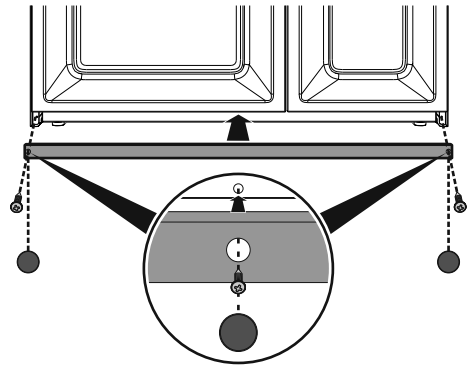



Installation

Positioning and levelling the appliance

After making the electrical and/or gas connections, properly level the appliance on the floor to ensure better stability. Screw or unscrew the bottom part of the foot until the appliance is stable and level on the floor.

