

Operating and installation instructions Steam ovens

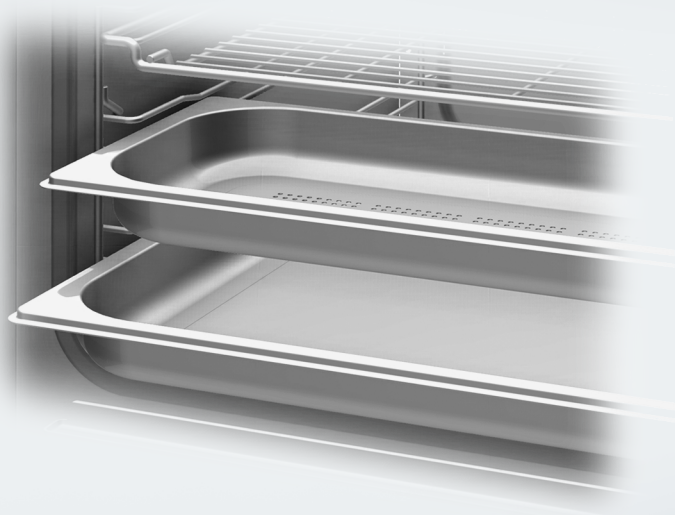

To avoid the risk of accidents or damage to the appliance it is **essential** to read these instructions before it is installed and used for the first time.

Contents

Warning and Safety instructions	5
Caring for the environment	13
Guide to the appliance	14
Steam oven	14
Accessories supplied	15
Controls	16
Display	17
Sensor controls	17
Symbols	17
Description of functions	18
Water container	18
Condensate tray	18
Temperature	18
Cooking duration	18
Noises	19
Heating-up phase	19
Cooking phase	19
Steam reduction	19
Before using for the first time	20
Cleaning for the first time	20
Setting the water hardness level	20
Setting the correct boiling point for water	21
Settings	22
Operation	25
Operating the steam oven	25
Changing values for a cooking programme	26
Interrupting a cooking programme	27
Automatic programmes	28
General notes	30
The advantages of cooking with steam	30
Suitable containers	30
Condensate tray	30
Shelf level	31
Frozen food	31
Temperature	31
Cooking duration	31

Cooking with liquid.....	31
Your own recipes.....	31
Steam cooking	32
Eco steam cooking.....	32
Notes on the cooking tables	32
Vegetables.....	33
Fish.....	36
Meat	39
Rice	41
Grain.....	42
Pasta	43
Dumplings	44
Dried pulses	45
Hen's eggs	47
Fruit	48
Sausages.....	48
Shellfish.....	49
Mussels	50
Menu cooking (cooking whole meals).....	51
Further applications	53
Reheat	53
Defrost.....	56
Blanching.....	59
Bottling	59
Disinfect items	62
Prove dough	62
Heating damp flannels	63
Dissolve gelatine	63
Decrystallise honey	64
Melt chocolate.....	64
Make yoghurt	65
Cook bacon.....	66
Sweat onions.....	66
Extracting juice with steam	67
Skinning vegetables and fruit.....	68
Apple storage	68
Making eierstich	68
Note for test institutes	69
Cleaning and care	70
Cleaning the steam oven front	71

Contents

Cleaning the oven compartment	72
Cleaning the water container	73
Accessories	73
Cleaning the side runners.....	74
Descaling the steam oven	74
Problem solving guide	76
Optional accessories	79
Service	80
Contact in case of malfunction	80
Warranty	80
Installation	81
Safety instructions for installation	81
Building-in dimensions	82
Installation in a tall unit.....	82
Installation in a base unit.....	83
Side view	84
Connection and ventilation.....	85
Installing the steam oven.....	86
Electrical connection	87

Warning and Safety instructions

This steam oven complies with all applicable safety requirements. Inappropriate use can, however, lead to personal injury and material damage.

Read the operating and installation instructions carefully before using the steam oven. They contain important information on safety, installation, use and maintenance. This prevents both personal injury and damage to the steam oven.

In accordance with standard IEC/EN 60335-1, Miele expressly and strongly advises that you read and follow the instructions in the chapter on installing the steam oven as well as the safety instructions and warnings.

Miele cannot be held liable for injury or damage caused by non-compliance with these instructions.

Keep these instructions in a safe place and pass them on to any future owner.

Warning and Safety instructions

Correct application

- ▶ This steam oven is intended for use in domestic households and similar working and residential environments.
- ▶ This steam oven is not intended for outdoor use.
- ▶ The steam oven is intended for domestic use only to steam-cook, defrost and reheat food.
All other types of use are not permitted.
- ▶ The steam oven can only be used by people with reduced physical, sensory or mental capabilities, or lack of experience and knowledge, if they are supervised whilst using it, or have been shown how to use it in a safe way and recognise and understand the consequences of incorrect operation.

Safety with children

- ▶ Children under 8 years of age must be kept away from the steam oven unless they are constantly supervised.
- ▶ Children aged 8 and older may only use the steam oven without supervision if they have been shown how to use it in a safe manner. Children must be able to understand and recognise the possible dangers caused by incorrect operation.
- ▶ Children must not be allowed to clean the steam oven unsupervised.
- ▶ Please supervise children in the vicinity of the steam oven and do not let them play with it.
- ▶ Risk of suffocation due to packaging material. Whilst playing, children may become entangled in packaging material (such as plastic wrapping) or pull it over their head, presenting the risk of suffocation. Keep packaging material away from children.
- ▶ Risk of injury caused by hot surfaces and steam. Children's skin is far more sensitive to high temperatures than that of adults. During operation, steam will escape out of the ventilation outlet. The door glass and control panel of the steam oven heats up. Do not let children touch the steam oven when it is in operation. Keep children well away from the steam oven until it has cooled down and there is no danger of injury.
- ▶ Risk of injury from the open door. The oven door can support a maximum weight of 8 kg. Children could injure themselves on an open door. Do not let children sit on the open door, lean against it or swing on it.

Warning and Safety instructions

Technical safety

- ▶ Unauthorised installation, maintenance and repairs can cause considerable danger for the user. Installation, maintenance and repairs must only be carried out by a Miele authorised technician.
- ▶ Never use a damaged steam oven. It could be dangerous. Check it for visible signs of damage before using it.
- ▶ Reliable and safe operation of this steam oven can only be assured if it has been connected to the mains electricity supply.
- ▶ The electrical safety of this appliance can only be guaranteed when correctly earthed. It is essential that this standard safety requirement is met. If in any doubt please have the electrical installation tested by a qualified electrician.
- ▶ Before connecting the appliance to the mains supply, ensure that the connection data on the data plate (voltage and frequency) match the mains electricity supply.
This data must correspond in order to avoid the risk of damage to the appliance. Consult a qualified electrician if in any doubt.
- ▶ Do not connect the steam oven to the mains electricity supply by a multi-socket adapter or an extension lead. These do not guarantee the required safety of the appliance (fire hazard).
- ▶ For safety reasons, this steam oven may only be used when it has been built in. This is necessary to ensure that all electrical components are shielded.
- ▶ This steam oven must not be used in a non-stationary location (e.g. on a ship).
- ▶ Never open the casing of the appliance. Tampering with electrical connections or components and mechanical parts is highly dangerous to the user and can cause operational faults.

Warning and Safety instructions

- ▶ While the appliance is under warranty, repairs should only be undertaken by a Miele authorised service technician. Otherwise the warranty is invalidated.
- ▶ Miele can only guarantee the safety of the appliance when genuine original Miele replacement parts are used. Faulty components must only be replaced by Miele spare parts.
- ▶ If the plug is removed from the connection cable or if the cable is supplied without a plug, the appliance must be connected to the electrical supply by a suitably qualified electrician.
- ▶ If the connection cable is damaged, it must be replaced with a special connection cable (see “Electrical connection”).
- ▶ During installation, maintenance and repair work, the appliance must be disconnected from the mains electricity supply.
- ▶ If the steam oven is installed behind a furniture front (e.g. a door), do not close the furniture front while the steam oven is in use. Heat and moisture can build up behind the furniture front when closed. This can result in damage to the steam oven, the housing unit and the floor. Leave the furniture door open until the steam oven has cooled down completely.
- ▶ In areas which may be subject to infestation by cockroaches or other vermin, pay particular attention to keeping the appliance and its surroundings clean at all times. Any damage caused by cockroaches or other vermin will not be covered by the warranty.

Warning and Safety instructions

Correct use

▶ Risk of injury caused by hot surfaces and steam. The steam oven gets hot during operation. You could burn yourself on the oven compartment, side runners, accessories, food or steam.

Wear oven gloves when placing hot food in the oven or removing it and when adjusting oven shelves, for example, in a hot oven compartment.

▶ Risk of injury caused by hot food.

Food may spill or splash around when placing it into the oven or removing it. The food can cause burns.

When placing cooking containers into the oven or removing them, make sure that the hot food does not spill.

▶ Risk of injury caused by hot water.

At the end of a cooking programme, hot water left in the steam generator is pumped back into the water container. Take care not to tip the water container when taking it out of the appliance.

▶ Do not use the steam oven to heat up or bottle food in sealed jars and tins.

Pressure will build up inside them and they can explode causing damage to the appliance, as well as the risk of injury and scalding.

▶ Plastic dishes which are not heat and steam-resistant melt at high temperatures and can damage the appliance.

Use only heat-resistant (to 100 °C) and steam-resistant plastic dishes. Follow the manufacturer's instructions.

▶ Food which is stored in the oven compartment can dry out and the moisture released can lead to corrosion damage in the steam oven. Do not leave food in the oven compartment and do not use any cooking containers which are susceptible to corrosion.

▶ Risk of injury from the open door. You could bang into the open door or trip over it. Avoid leaving the door open unnecessarily.

Warning and Safety instructions

- ▶ The door can support a maximum weight of 8 kg. Do not sit on or lean against an open door, and do not place heavy objects on it. Also make sure that nothing can get trapped between the door and the oven cavity. The steam oven could get damaged.
- ▶ When using a small electrical appliance, e.g. a hand-held blender, near the steam oven, care should be taken that the cable of the appliance cannot get trapped by the steam oven door. The insulation on the cable could become damaged, giving rise to an electric shock hazard.

Warning and Safety instructions

Cleaning and care

- ▶ Risk of injury due to electric shock. The steam from a steam cleaning appliance could reach live electrical components and cause a short circuit. Do not use a steam cleaner to clean the appliance.
- ▶ Scratches on the door glass can result in the glass breaking. Do not use abrasive cleaners, hard sponges, brushes or sharp metal tools to clean the door glass.
- ▶ The side runners can be removed (see “Cleaning and care – Cleaning the side runners”).
Refit the side runners correctly.
- ▶ Try to avoid the interior walls being splashed with food or liquids containing salt. If it does happen, wipe these away thoroughly to avoid corrosion to stainless steel surfaces inside the cabinet.

Accessories

- ▶ Only use genuine original Miele accessories and spare parts with this appliance. Using accessories or spare parts from other manufacturers will invalidate the warranty and Miele cannot accept liability.

Disposal of the packing material

The packaging is designed to protect the appliance from damage during transportation. The packaging materials used are selected from materials which are environmentally friendly for disposal and should be recycled.

Recycling the packaging reduces the use of raw materials in the manufacturing process and also reduces the amount of waste in landfill sites.

Disposing of your old appliance

Electrical and electronic appliances often contain valuable materials. They also contain specific materials, compounds and components, which were essential for their correct function and safety. These could be hazardous to human health and to the environment if disposed of with your domestic waste or if handled incorrectly. Please do not, therefore, dispose of your old appliance with your household waste.



Please dispose of it at your local community waste collection / recycling centre for electrical and electronic appliances, or contact your dealer or Miele for advice. You are also responsible (by law, depending on country) for deleting any personal data that may be stored on the appliance being disposed of. Please ensure that your old appliance poses no risk to children while being stored prior to disposal.

Guide to the appliance

Steam oven

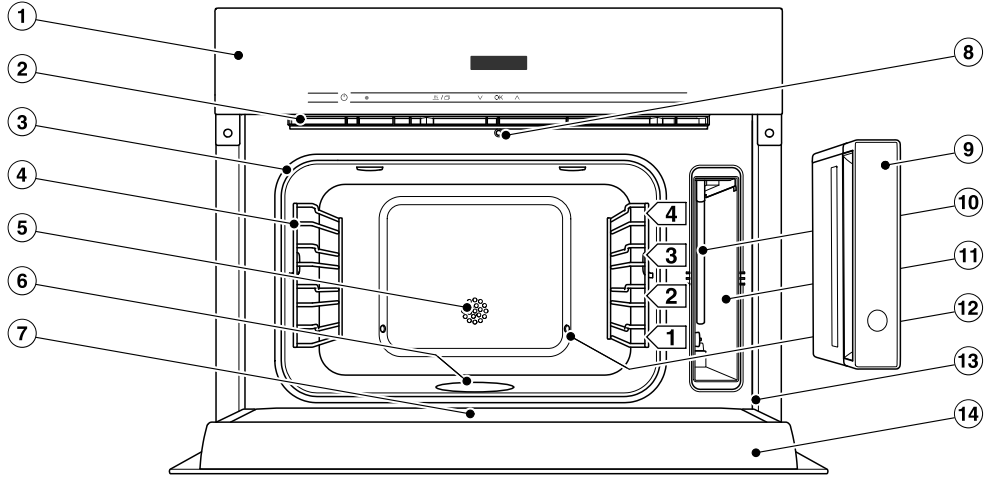

- ① Control elements
- ② Ventilation outlet
- ③ Door seal
- ④ Side runners with 4 shelf levels
- ⑤ Temperature sensor
- ⑥ Floor heater element
- ⑦ Drip channel
- ⑧ Automatic door release for steam reduction
- ⑨ Water container with removable spill guard
- ⑩ Suction tube
- ⑪ Compartment for water container
- ⑫ Steam inlet
- ⑬ Front frame with data plate
- ⑭ Door

A list of the models described in these operating and installation instructions can be found on the back page.

Data plate

The data plate is located on the front frame, visible when the door is open.

The data plate states the model number, the serial number as well as connection data (voltage, frequency and maximum rated load).

Please have this information to hand, should you need to contact Miele regarding any questions or problems.

Accessories supplied

The accessories supplied with your appliance as well as a range of optional ones are available to order from Miele (see "Optional accessories").

DGG 1/1-40 L

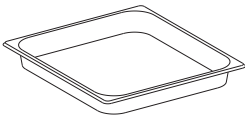

1 condensate tray

For collecting excess moisture.

You can also use the condensate tray as a cooking container.

375 x 394 x 40 mm (W x D x H)

DGG 1/2-40L

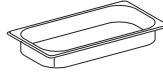

1 solid cooking container

Gross capacity 2.2 litres /

Usable capacity 1.6 litres

375 x 197 x 40 mm (W x D x H)

DGGL 1/2-40L

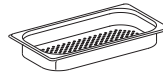

2 perforated cooking containers

Gross capacity 2.2 litres /

Usable capacity 1.6 litres

375 x 197 x 40 mm (W x D x H)

DMSR 1/1L





1 rack for placing your own crockery on

Descaling tablets

For descaling the appliance

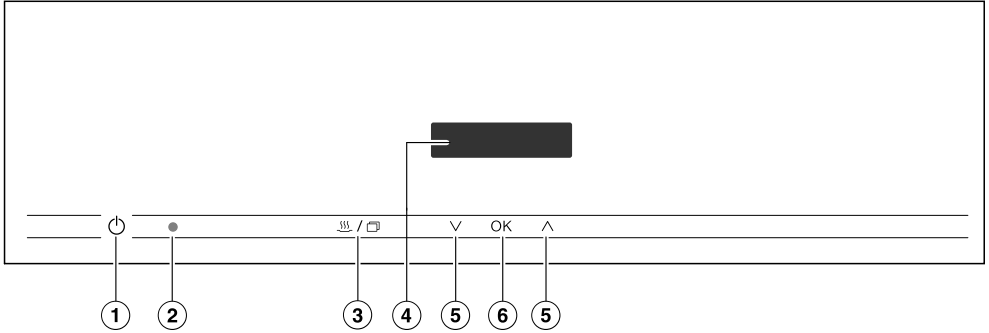
Controls



- ① Recessed ① On/Off control
For switching the steam oven on and off
- ② Optical interface
(For Miele Service only)
- ③  sensor
For alternating between steam cooking, *ECD* steam cooking and automatic programmes
- ④ Display
For displaying operational information
- ⑤ ∇ \blacktriangle sensors
For changing values and settings and scrolling through lists
- ⑥ OK sensor
For confirming entries and selecting and saving settings

Display



The display is used to show information about temperatures, cooking durations, automatic programmes and settings.

Sensor controls

The sensors react to touch. Each touch is confirmed with a keypad tone. This keypad tone can be switched off (see “Settings”).

Symbols

The following symbols and indicators may appear in the display during operation:

Symbol/indicator	Meaning
	Steam cooking
 (flashes)	Insufficient water or water container not present
<i>EEO</i>	<i>EEO</i> steam cooking
Auto <i>R</i> + number(s)	Automatic programme
Numbers + °C	Temperature
Numbers + h	Cooking duration
 + number(s)	The steam oven needs to be descaled (see “Cleaning and care – Descaling the steam oven”)

Description of functions

Water container

The maximum filling volume is 1.5 litres and the minimum is 0.5 litres. There are markings on the water container. The upper marking must never be exceeded.

Water consumption depends on the type of food and the duration of cooking. The water may need to be topped up during cooking. Water consumption is increased if the door is opened during cooking.

The water container is removed using a push/pull system: push gently on the water container to remove it.

At the end of a cooking programme, hot water left in the steam generator is pumped back into the water container. The water container must be emptied after each use involving steam.

Condensate tray

Place the condensate tray on shelf level 1 when using perforated containers. This collects any drops of liquid and allows these to be removed easily.

You can also use the condensate tray as a cooking container if necessary.

Temperature

The steam oven has a temperature range of 40 °C to 100°C. The appliance is set at 100 °C when the oven is switched on. You can alter the temperature in 5 °C steps.

Recommended temperatures

Temperature	Application
100 °C	<ul style="list-style-type: none">– Cooking all types of food– Reheating– Menu cooking– Preserving– Juicing
85 °C	<ul style="list-style-type: none">– Cooking fish gently
50–60 °C	<ul style="list-style-type: none">– Defrosting
40 °C	<ul style="list-style-type: none">– Proving dough– Making yoghurt

Cooking duration

You can set a cooking duration of between 1 minute (0:01) and 9 hours 59 minutes (9:59). If the duration exceeds 59 minutes you have to enter it in hours and minutes.
Example: Duration 80 minutes = 1:20.

Noises

You will hear a pumping sound when the appliance is switched on, during use and after switching it off. This is the sound of water being pumped through the system and is quite normal.

When the steam oven is in use, you will hear a fan noise.

Heating-up phase

During the heating-up phase the oven compartment is heated to the set temperature. The display shows the temperature in the oven compartment as it rises.

The duration of the heating-up phase will depend on the quantity and temperature of the food. In general, the heating-up phase will last for approx. 7 minutes. The duration will be longer if you are cooking refrigerated or frozen food and if you are cooking at low temperatures.

Cooking phase

The cooking phase begins when the set temperature is reached. During the cooking phase, the duration remaining will be shown in the display.

Steam reduction

If a cooking temperature above approx. 80 °C has been set, the appliance door will automatically open a fraction just before the end of a cooking programme to release some of the steam from the cabinet. The door will then close again automatically.

Steam reduction can be switched off if you wish (see “Settings”). If switched off there will be a lot of steam emitted from the cabinet when the door is opened.

Before using for the first time

Cleaning for the first time

- Remove any protective wrapping and stickers from the steam oven and accessories.

The appliance has undergone a function test in the factory. Residual water from this testing may have trickled back into the cabinet during transportation.

Cleaning the water container

- Remove the water container.
- Remove the spill guard.
- Wash the water container by hand.

Cleaning accessories/oven compartment

- Take all accessories out of the oven.
- Wash the accessories in a mild solution of washing-up liquid and hot water or in the dishwasher.

The interior of the steam oven has been treated at the factory with a conditioning agent.

- To remove this, clean the oven compartment with a clean sponge and a mild solution of washing-up liquid and hot water.

Setting the water hardness level

To ensure that the steam oven works correctly and to ensure that descaling is carried out at the correct interval, it must be adjusted to the local water hardness level.

The harder the water is, the more frequently the steam oven needs to be descaled.

The hardness level is set to 15 °dH by default.

Contact your local water supplier to find out your local water hardness range if necessary.

- Adjust the setting of your local water supply if necessary (see “Settings”).

Before using for the first time

Setting the correct boiling point for water

Before cooking food for the first time, you must adjust the boiling temperature of the water, which varies depending on the altitude of where the steam oven is located. This procedure also flushes out the waterways.

This procedure **must** be carried out to ensure efficient functioning of your appliance.

Distilled or carbonated water or other liquids could damage the steam oven.

Only use cold, fresh tap water (below 20 °C).

- Remove the water container and fill it up to the maximum marker.
- Push the water container into the appliance.
- Run the steam oven for 15 minutes using the steam cooking  function (100 °C). Proceed as described in “Operation”.

Setting the correct boiling point for water following a house move

If you move house, the appliance will need to be re-set for the new altitude if this differs from the old one by 300 m or more. To do this, descale the appliance (see “Cleaning and care – Descaling the steam oven”).

Settings

Changing and saving settings

Your steam oven is supplied with a number of standard default settings. The standard settings listed in the chart below can be altered.

With the steam oven **switched off**:

- Touch and hold the ∨ sensor.
- Whilst pressing the ∨ sensor, touch the On/Off ⓪ button once briefly.

P1 will appear.

- Touch the ∨ or ∧ sensors to set the required programme.
- Confirm with *OK*.

S and a number will appear.

- Touch the ∨ or ∧ sensors to set the required status/water hardness.
- Confirm with *OK*.

The selected status will be saved.

- After you have altered the setting(s) required, switch the steam oven off.

The factory default setting is shown in **bold**.

Programme		Status/water hardness	Available settings
P1	Water hardness	15°	See “Settings – Water hardness”
P2	Buzzer volume	S1 S2 S3 S4	Very quiet Quiet Loud Very loud
P3	Keypad tone	S0 S1	Off On
P4	Steam reduction	S0 S1	Off On
P5	Temperature unit	S1 S2	°C °F
P6	Demo mode	S0 S1	Off, the steam oven heats up On, the steam oven does not heat up

Settings

Water hardness

Contact your local water supplier to find out your local water hardness range if necessary.

The degree of hardness can be set between 1 °dH and 70 °dH.

If you are using bottled drinking water, such as mineral water, be sure not to use carbonated water. Select settings according to the calcium content. The calcium content is given on the label of the bottle in mg/l Ca²⁺ or ppm (mg Ca²⁺/l).

Water hardness		Calcium content mg/l Ca ²⁺ or ppm (mg Ca ²⁺ /l)	Setting
°dH	mmol/l		
1	0.2	7	1°
2	0.4	14	2°
3	0.5	21	3°
4	0.7	29	4°
5	0.9	36	5°
6	1.1	43	6°
7	1.3	50	7°
8	1.4	57	8°
9	1.6	64	9°
10	1.9	71	10°
11	2.0	79	11°
12	2.2	86	12°
13	2.3	93	13°
14	2.5	100	14°
15	2.7	107	15°
16	2.9	114	16°
17	3.1	121	17°

Water hardness		Calcium content mg/l Ca ²⁺ or ppm (mg Ca ²⁺ /l)	Setting
°dH	mmol/l		
18	3.2	129	18°
19	3.4	136	19°
20	3.6	143	20°
21	3.8	150	21°
22	4.0	157	22°
23	4.1	164	23°
24	4.3	171	24°
25	4.5	179	25°
26	4.7	186	26°
27	4.9	193	27°
28	5.0	200	28°
29	5.2	207	29°
30	5.4	214	30°
31	5.6	221	31°
32	5.8	229	32°
33	5.9	236	33°
34	6.1	243	34°
35	6.3	250	35°
36	6.5	257	36°
37–45	6.6–8.0	258–321	37°–45°
46–60	8.2–10.7	322–429	46°–60°
61–70	10.9–12.5	430–500	61°–70°

Operating the steam oven

Distilled or carbonated water or other liquids could damage the steam oven.

Only use cold, fresh tap water (below 20 °C).

- Fill the water container and push it into the appliance.
- Place the condensate tray on shelf level 1 when using perforated containers.
- Place the food in the oven.
- Switch the steam oven on.



 100 °C will appear. 100 will flash.

- If you want to cook with 100 °C, confirm the setting with *OK*.
- If you wish, you can set a lower temperature by touching the ∇ sensor. Confirm with *OK*.

This temperature will be automatically accepted within a few seconds. Touch *OK* twice to go back to the temperature selection option.



 0:00 h will appear.

The 0 symbol for the hours will flash.

- If you want to set a cooking duration of
 - less than 1 hour, confirm with *OK*
 - more than 1 hour, set the cooking duration you want by touching the \wedge sensor (from 0 upwards) or ∇ (from 9 downwards) and confirm with *OK*.
- Set the minutes you want by touching the \wedge sensor (from 00 upwards) or ∇ (from 59 downwards).
- Confirm with *OK*.

The actual temperature will appear and the heating-up phase will commence.

You will see the temperature increasing. A buzzer will sound when the set temperature is reached for the first time.

The cooking duration will begin to count down.

If you are cooking at a temperature of approx. 80 °C, shortly before the end of the cooking duration, the door will automatically open a little to allow some of the steam to escape from the oven compartment.

The buzzer will sound at the end of the cooking duration.

- Take the food out of the oven.
- Switch the steam oven off.

A new cooking programme can only be started if the automatic door release is retracted into its original position. Do not push it in manually as this could damage it.

Operation

Cleaning the steam oven

- If necessary, remove the condensate tray from the oven compartment and empty it.

 Risk of injury caused by hot water.

At the end of a cooking programme, hot water left in the steam generator is pumped back into the water container.

Take care not to tip the water container when taking it out of the appliance.

- Remove the water container.
- Remove the spill guard and empty the water container.
- After each use, clean and dry the whole appliance as described in “Cleaning and care”.

Make sure the spill guard engages correctly when installing it.

- Leave the appliance door open until the oven compartment is completely dry.

Refilling the water

Insufficient water during a cooking programme is indicated by the flashing  symbol and a buzzer.

- Remove the water container and fill it with fresh tap water.
- Push the water container back into the appliance.

The cooking programme will continue.

Changing values for a cooking programme

As soon as a cooking programme is in progress, you can change the temperature and cooking duration for this programme.

Changing the temperature

- Touch *OK* once.

The display will change to the temperature setting and the temperature will flash.

- Touch the \vee or \wedge sensors to change the temperature.
- Confirm with *OK*.

Changing the cooking duration

- Touch *OK* twice.

The display will change to setting the cooking duration and the number for the hours will flash.

- Touch the \vee or \wedge sensors to change the cooking duration.
- Confirm with *OK*.

Interrupting a cooking programme

A cooking programme is interrupted as soon as the door is opened. The oven heating switches off. Set cooking durations will be saved.

 Risk of injury caused by hot steam.

A great deal of hot steam can escape when the door is opened. The steam can cause burns.

Step back and wait until the hot steam has dissipated.

 Risk of injury caused by hot surfaces and food.

The steam oven gets hot during operation. You could burn yourself on the oven compartment, side runners, accessories or the food itself.

Use oven gloves when placing food in the oven compartment or removing it and when working in the hot oven compartment.

When placing cooking containers into the oven or removing them, make sure that the hot food does not spill.

The cooking programme will resume when the door is closed.

When the door is closed, the pressure has to equalise, which can cause a whistling sound.

The steam oven will heat up again and the display will show the temperature in the oven compartment as it rises. Once the set temperature has been reached, the display will show the time left as it counts down.

The cooking programme will finish early if the door is opened in the last minute of cooking.

Automatic programmes

Your steam oven is equipped with over 20 automatic programmes for cooking vegetables. The temperature and cooking duration are pre-set, so you only have to prepare the vegetables as required (see the “Programme overview” chart).

The oven compartment needs to be at room temperature before starting an automatic programme.

For hints and tips on cooking vegetables by steam, see “Steam cooking – Vegetables”.

Using automatic programmes

- Put the prepared vegetables into a perforated cooking container.
- Place the condensate tray on shelf level 1.
Place the perforated container on any shelf level.
- Fill the water container and push it into the appliance.
- Switch the steam oven on.
- Touch the  sensor.

ECC will appear.

You can switch to the automatic programmes by touching the \vee or \wedge sensors.

- Set the programme you want with the \vee or \wedge sensors, e.g. A15.
- Confirm with *OK*.
- Set the degree of cooking you want with the \vee or \wedge sensor:
 - al dente \cdot
 - medium $\cdot \cdot$
 - soft $\cdot \cdot \cdot$
- Confirm with *OK*.

Programme overview

Programme no.	Vegetables	
A1	Cauliflower	Florets, medium
A2	Beans (green, yellow)	Whole
A3	Broccoli	Florets, medium
A4	Chinese cabbage	Chopped
A5	Peas	—
A6	Fennel	Chopped
A7	Kohlrabi	Batons
A8	Pumpkin	Diced
A9	Corn	Cobs
A10	Carrots	Diced/batons/sliced
A11	Pepper	Chopped
A12	Potatoes in the skin	Firm, medium
A13	Leeks	Rings
A14	Romanesco	Florets, medium
A15	Brussels sprouts	—
A16	Boiled potatoes	Firm, quartered
A17	Asparagus, green	Medium
A18	White asparagus	Medium
A19	Spinach	—
A20	Sugar snap peas	—

General notes

This section contains general information. You will find more detailed information about particular foods and how to cook them in the other sections.

The advantages of cooking with steam

Almost all vitamins and minerals are retained as the food is not immersed in water.

Cooking with steam also retains the true taste of the food better than conventional cooking. We therefore recommend seasoning the food after it has been cooked. Food also retains its fresh, original colour.

Suitable containers

Cooking containers

This steam oven is supplied with stainless steel cooking containers. Other containers, in a variety of sizes, both perforated and solid, are available as optional extras (see “Optional accessories”). This enables you to choose the most suitable container for the food you are cooking.

It is best to use perforated containers for steam cooking. The steam can reach the food from all sides and the food is cooked evenly.

Your own containers

You can also use your own containers. However, please note the following:

- Containers must be heat-resistant to 100 °C and able to withstand steam. With plastic containers please check with the manufacturer that they are suitable for use in a steam oven.
- Thick-sided containers such as porcelain, ceramic, or stoneware are not very suitable for using with steam. Due to their thick sides, they do not conduct heat well and as a result cooking durations will be considerably longer than those given in the tables.
- Place the cooking container on the rack or in a suitable container, and not on the oven floor.
- Ensure that there is a gap between the upper rim of the container and the top of the cooking compartment to allow sufficient steam into the container.

Condensate tray

Place the condensate tray on shelf level 1 when using perforated containers. This collects any drops of liquid and allows these to be removed easily.

You can also use the condensate tray as a cooking container if necessary.

Shelf level

You can select any shelf level. You can also cook on several levels at the same time. This will not alter the cooking duration.

When using more than one deep container at the same time for steam cooking, it is best to offset them on their runners and to leave at least one level free in between them.

Always insert cooking containers and the rack between the rails of the shelf level supports so that they cannot tip.

Frozen food

The heating up phase for frozen food is longer than for fresh food. The greater the quantity of frozen food, the longer the heating up phase.

Temperature

During steam cooking, the temperature does not exceed 100 °C. Almost all foods can be cooked at this temperature. Some types of food, such as berries, need to be cooked at lower temperatures to prevent them from bursting. See the relevant sections in these operating instructions for more details.

Cooking duration

During steam cooking, the cooking duration does not begin until the set temperature is reached.

In general, the cooking durations for cooking with steam are the same as for cooking food in a saucepan. More information about any factors which may affect the cooking duration is given in the relevant sections.

The quantity of food does not affect the cooking duration. 1 kg of potatoes will take the same time to cook as 500 g.

Cooking with liquid

When cooking with liquid only fill the cooking container $\frac{2}{3}$ full to prevent the liquid spilling when the cooking container is removed from the oven.

Your own recipes

Food which is cooked in a pot or a pan can also be cooked in the steam oven. The cooking durations in the steam oven will be the same. Please note that food will not be brown or crisp when cooking with steam.

Steam cooking

Eco steam cooking

To save energy when cooking with steam, you can use Eco steam cooking. Eco steam cooking is particularly suitable for cooking vegetables and fish. Eco steam cooking is less suitable for cooking foods containing starch, such as potatoes, rice and pasta.

We recommend using the cooking durations and temperatures given in the chart under “Steam cooking”. You can cook further if necessary.

- Switch the steam oven on.
- Touch the  sensor.
ECD will appear in the display.
- Confirm with *OK*.
- Set the temperature and cooking duration.

Notes on the cooking tables

Follow the instructions on cooking durations, temperatures and cooking notes.

Selecting the cooking duration

The cooking durations given are guidelines only.

- We recommend selecting the shorter duration initially. You can cook for longer if necessary.

Vegetables

Fresh

Prepare fresh vegetables in the usual way, i.e. wash, clean and cut them up.

Frozen food

Frozen vegetables do not need to be defrosted beforehand, unless they have been frozen together in a block.

Frozen and fresh vegetables which take the same length of time to cook can be cooked together.

If vegetables have frozen together in clumps, break these up before cooking with steam. Follow the manufacturer's instructions on the packaging regarding cooking duration.

Cooking containers

Food such as peas or asparagus spears, which have little or no space between them, will take longer to cook because the steam has less space to work in. For an even result, it is best to use a shallow container for these types of food, and only fill it about 3-5 cm deep. When cooking large quantities divide the food between 2 or 3 shallow containers rather than using one deep one.

Different types of vegetables which take the same length of time to cook can be cooked together.

Use solid containers for vegetables which are cooked in liquid.

Shelf level

To avoid any colour transfer when cooking vegetables with a distinctive colour (e.g. beetroot) in a perforated container, do not place other food underneath the perforated container.

Cooking duration

The cooking duration depends on the size of the food and how well cooked you want it, just as it does with conventional cooking methods. Example:

Waxy potatoes, cut into quarters:
approx. 17 minutes

Waxy potatoes, cut in half:
approx. 20 minutes

Settings

Steam cooking 

Temperature: 100 °C

Duration: see chart

Steam cooking

Vegetables	 [min]
Artichokes	32–38
Cauliflower, whole	27–28
Cauliflower, florets	8
Beans, green	10–12
Broccoli, florets	3–4
Chantenay carrots, whole	7–8
Chantenay carrots, halved	6–7
Chantenay carrots, chopped	4
Chicory, halved	4–5
Chinese cabbage, chopped	3
Peas	3
Fennel, halved	10–12
Fennel, sliced	4–5
Kale, chopped	23–26
Waxy potatoes, peeled whole halved quartered	27–29 21–22 16–18
Mainly waxy potatoes, peeled whole halved quartered	25–27 19–21 17–18
Floury potatoes, peeled whole halved quartered	26–28 19–20 15–16
Kohlrabi, cut into batons	6–7
Pumpkin, diced	2–4
Corn on the cob	30–35
Chard, chopped	2–3

Steam cooking

Vegetables	 [min]
Peppers, diced or sliced	2
New potatoes, firm	30–32
Mushrooms	2
Leeks, sliced	4–5
Leeks, halved lengthways	6
Romanesco, whole	22–25
Romanesco, florets	5–7
Brussels sprouts	10–12
Beetroot, whole	53–57
Red cabbage, chopped	23–26
Black salsify, whole	9–10
Celeriac, cut into batons	6–7
Asparagus, green	7
Asparagus, white, whole	9–10
Carrots, chopped	6
Spinach	1–2
Spring cabbage, chopped	10–11
Celery, chopped	4–5
Swede, chopped	6–7
White cabbage, chopped	12
Savoy cabbage, chopped	10–11
Courgettes, sliced	2–3
Sugar snap peas	5–7

 Cooking duration

Steam cooking

Fish

Fresh

Prepare fresh fish in the usual way, i.e. clean, gut and fillet.

Frozen food

Fish does not need to be fully defrosted before cooking. Defrost so that the surface is sufficiently thawed to take herbs and seasoning. Depending on the thickness of the fish, 2 - 5 minutes should be enough.

Preparation

Add some lemon or lime juice to fish before cooking. The citric acid helps the flesh stay firm.

It is not necessary to season fish with salt when cooking with steam as this method retains the minerals which give the fish its unique flavour.

Cooking containers

If using a perforated container, grease it first.

Shelf level

When cooking fish in a perforated container at the same time as cooking other types of food in other containers, place the container with the fish directly above the glass or collecting tray (depending on the model) to catch any liquid and so avoid any transfer of flavours to other food.

Temperature

85 °C – 90 °C

For gently cooking delicate types of fish, such as sole.

100 °C

For cooking firmer types of fish, e.g. cod and salmon.
Also for cooking fish in sauce or stock.

Duration

The cooking duration depends on the thickness and the texture of the fish, and not on the weight. The thicker the fish, the longer the cooking duration. A 3 cm thick piece of fish weighing 500 g will take longer to cook than a 2 cm thick piece of fish weighing 500 g.

The longer fish cooks, the firmer its flesh will become. Use the cooking durations given in the chart. If you find that the fish is not cooked sufficiently only cook it for a few minutes more.

When cooking fish in sauce or stock, we recommend that you increase the cooking duration quoted by a few minutes.

Tips

- Adding herbs and spices, such as dill, will help bring out the full flavour of the fish.
- Cook large fish in swimming position. To help maintain the shape of the fish, place a small cup or similar upside down in the cooking container, and arrange the fish belly-side down over the cup.
- You can use any fish scraps, e.g. fish heads, bones, tails etc to make a **fish stock**. Place the fish scraps together with some mixed vegetables in a solid cooking container and add cold water. Cook at 100 °C for 60 to 90 minutes. The longer the cooking duration, the stronger the stock.
- Preparing fish **au bleu** is a method involving cooking the fish in water with vinegar, at different proportions depending on the recipe. It is important not to damage the skin of the fish. This method is suitable for cooking carp, trout, tench, eel and salmon.

Settings

Steam cooking 

Temperature: see chart

Duration: see chart

Steam cooking

Fish	🌡️ [°C]	🕒 [min]
Eel	100	5–7
Perch fillet	100	8–10
Seabream fillet	85	3
Trout, 250 g	90	10–13
Halibut fillet	85	4–6
Cod fillet	100	6
Carp, 1.5 kg	100	18–25
Salmon fillet	100	6–8
Salmon steak	100	8–10
Salmon trout	90	14–17
Basa fillet	85	3
Rosefish fillet	100	6–8
Haddock fillet	100	4–6
Plaice fillet	85	4–5
Monkfish fillet	85	8–10
Sole fillet	85	3
Turbot fillet	85	5–8
Tuna fillet	85	5–10
Pike perch fillet	85	4

🌡️ Temperature 🕒 Duration

Meat

Fresh

Prepare the meat in the usual way.

Frozen food

Meat should be thoroughly defrosted before cooking in the steam oven (see “Special applications” – “Defrost”).

Preparation

For meat which needs to be seared before being cooked, e.g. for a stew, sear the meat in a pan on the hob first.

Duration

The cooking duration depends on the thickness and the texture of the meat, and not on the weight. The thicker the piece of meat, the longer the cooking duration. A piece of meat weighing 500 g which is 10 cm thick will take longer to cook than a piece of meat weighing 500 g which is 5 cm thick.

Tips

- To retain the **flavourings**, use a perforated cooking container. Place an unperforated cooking container underneath in order to collect the concentrate. You can use the concentrate to enhance your sauces or freeze it for later use.
- Boiling fowl, back or top rib and meat bones can be used to make **stock**. Place the meat together with the bones and some mixed vegetables in a cooking container and add cold water. The longer the cooking duration, the stronger the stock.

Settings

Steam cooking 
Temperature: 100 °C
Duration: see chart

Steam cooking

Meat	🕒 [min]
Leg steak, covered with water	110–120
Pork knuckle	135–140
Chicken breast	8–10
Hock	105–115
Top rib, covered with water	110–120
Veal strips	3–4
Gammon slices	6–8
Lamb stew	12–16
Poularde	60–70
Turkey roulades	12–15
Turkey escalopes	4–6
Short rib, covered with water	130–140
Beef goulash	105–115
Whole chicken, covered with water	80–90
Topside	110–120

🕒 Cooking duration

Rice

Rice swells when cooked and needs to be cooked in liquid. The proportion of rice to liquid will vary depending on the type of rice.

The rice absorbs all the liquid during the cooking process and so none of the nutrients are lost.

Settings

Steam cooking 

Temperature: 100 °C

Duration: see chart

	Ratio Rice : Liquid	 [min]
Basmati rice	1 : 1.5	15
Parboiled rice	1 : 1.5	23–25
Round grain rice		
Pudding rice	1 : 2.5	30
Risotto rice	1 : 2.5	18–19
Brown rice	1 : 1.5	26–29
Wild rice	1 : 1.5	26–29

 Duration

Steam cooking

Grain

Grain swells during cooking and needs to be cooked in liquid. The proportion of grain to liquid depends on the type of grain.

Grain can be cooked whole or cracked.

Settings

Steam cooking 

Temperature: 100 °C

Duration: see chart

	Ratio Grain : Liquid	 [min]
Amaranth	1 : 1.5	15–17
Bulgur	1 : 1.5	9
Green spelt, whole	1 : 1	18–20
Green spelt, cracked	1 : 1	7
Oats, whole	1 : 1	18
Oats, cracked	1 : 1	7
Millet	1 : 1.5	10
Polenta	1 : 3	10
Quinoa	1 : 1.5	15
Rye, whole	1 : 1	35
Rye, cracked	1 : 1	10
Wheat, whole	1 : 1	30
Wheat, cracked	1 : 1	8

 Duration

Pasta

Dry pasta

Dry pasta swells when it is cooked and needs to be cooked in liquid. The liquid must cover the pasta. Using hot liquid gives better results.

Increase the cooking time stated by the manufacturer by approx. $\frac{1}{3}$.

Fresh food

Fresh pasta, such as the kind you can buy from the supermarket chilled counter, does not need to absorb water. Cook fresh pasta in a greased perforated container.

Separate any pieces of pasta which have stuck together and spread them out in the cooking container.

Settings

Steam cooking 

Temperature: 100 °C

Duration: see chart

Fresh	 [min]
Gnocchi	2
Knöpfli	1
Ravioli	2
Spätzle	1
Tortellini	2
Dry pasta, covered with water	
Tagliatelli	14
Vermicelli	8

 Duration

Steam cooking

Dumplings

Ready made boil-in-the-bag dumplings need to be well covered with water as otherwise they can fall apart. This is because even though they have been soaked in water beforehand they will not absorb enough moisture.

Cook fresh dumplings in a greased, perforated container.

Settings

Steam cooking 

Temperature: 100 °C

Duration: see chart

	 [min]
Sweet dumplings	30
Yeast dumplings	20
Boil-in-the-bag potato dumplings	20
Boil-in-the-bag bread dumplings	18–20

 Duration

Dried pulses

Soak pulses for at least 10 hours in cold water before cooking. Soaking makes the pulses more digestible and shortens the cooking duration required. Soaked pulses must be covered with liquid during cooking.

Lentils do not need to be soaked before cooking.

With unsoaked pulses a certain ratio of pulses to liquid is required depending on variety.

Settings

Steam cooking 

Temperature: 100 °C

Duration: see chart

Soaked	
	 [min]
Beans	
Kidney beans	55–65
Adzuki beans	20–25
Black beans	55–60
Pinto beans	55–65
Haricot beans	34–36
Peas	
Yellow split peas	40–50
Green split peas	27

 Duration

Steam cooking

Unsoaked		
	Ratio Pulses : Liquid	🕒 [min]
Beans		
Kidney beans	1 : 3	130–140
Adzuki beans	1 : 3	95–105
Black beans	1 : 3	100–120
Pinto beans	1 : 3	115–135
Haricot beans	1 : 3	80–90
Lentils		
Brown lentils	1 : 2	13–14
Red lentils	1 : 2	7
Peas		
Yellow split peas	1 : 3	110–130
Green split peas	1 : 3	60–70

🕒 Duration

Hen's eggs

Use a perforated container to boil eggs in the steam oven.

The eggs do not need to be pierced before cooking as they are gradually warmed during the heating up phase and so do not burst when they are cooked with steam.

When using a solid container for making egg dishes such as scrambled eggs, remember to grease it first.

Settings

Steam cooking 

Temperature: 100 °C

Duration: see chart

	 [min]
Small soft medium hard	 3 5 9
Medium soft medium hard	 4 6 10
Large soft medium hard	 5 6–7 12
Extra large soft medium hard	 6 8 13

 Duration

Steam cooking

Fruit

Cook fruit in a solid container so that none of the juice is lost. If you wish to cook fruit in a perforated container, place a solid container directly underneath it to collect the juice.

Tip: You can use the juice which has collected in the solid container to make a glaze for a fruit flan.

Settings

Steam cooking 
Temperature: 100 °C
Duration: see chart

	 [min]
Apple chunks	1–3
Pear chunks	1–3
Cherries	2–4
Mirabelle plums	1–2
Nectarine/peach chunks	1–2
Plums	1–3
Quinces, diced	6–8
Rhubarb chunks	1–2
Gooseberries	2–3

 Cooking duration

Sausages

Settings

Steam cooking 
Temperature: 90 °C
Duration: see chart

Sausages	 [min]
Frankfurters	6–8
Bologna sausages	6–8
Veal sausages	6–8

 Duration

Shellfish

Preparation

Defrost frozen shellfish before cooking with steam.

Peel, remove and discard the intestines, and then wash the shellfish.

Cooking containers

If using a perforated container, grease it first.

Duration

The longer shellfish are cooked, the tougher they become. Use the cooking durations given in the chart.



When cooking shellfish in sauce or stock, we recommend that you increase the cooking duration quoted by a few minutes.

Settings

Steam cooking 

Temperature: see chart

Duration: see chart

	 [°C]	 [min]
Crevettes	90	3
Prawns	90	3
King prawns	90	4
Small shrimps	90	3
Lobster	95	10–15
Large shrimps	90	3

 Temperature  Duration

Steam cooking

Mussels

Fresh food

 Danger of food poisoning from spoiled mussels.
Spoiled mussels can cause food poisoning.
Only cook mussels which are closed.
Do not eat mussels which have not opened after being cooked.

Steep fresh mussels in water for a few hours before cooking to rinse out any sand. Then scrub the mussels thoroughly to clean them.

Frozen food

Defrost frozen mussels before cooking.

Duration



The longer mussels are cooked, the tougher they become. Use the cooking durations given in the chart.

Settings

Steam cooking 

Temperature: see chart

Duration: see chart

	 [°C]	 [min]
Barnacles	100	2
Cockles	100	2
Mussels	90	12
Scallops	90	5
Razor clams	100	2–4
Venus clams	90	4

 Temperature  Duration

Menu cooking (cooking whole meals)

Before cooking meals with the manual menu cooking function, switch off steam reduction (see “Settings – Steam reduction”).

When cooking a menu, you can combine different foods with different cooking durations, e.g. fish fillet with rice and broccoli.

The food is placed in the steam oven compartment at different times so that each item is ready at the same time.

Shelf level

Place foods that produce a lot of liquids (e.g. fish) or have a distinctive colour (e.g. beetroot) directly above the glass tray or condensate tray (depending on the model). This avoids any transfer of flavour or colour to other food and prevents liquid dripping onto food below it.

Temperature

Whole meals should be cooked at a temperature of 100 °C as this is the temperature required to cook the majority of foods.

Do not cook a whole meal at the lowest temperature when different temperatures are required for different types of food, e.g. 85 °C for seabream and 100 °C for potatoes.

If the recommended cooking temperature for the food is 85 °C for example, try cooking it at 100 °C and testing the result. Some delicate types of fish with a soft structure, e.g. sole and plaice will become very firm when cooked at 100 °C.

Duration

If you are increasing the recommended temperature, shorten the cooking duration by approx. $\frac{1}{3}$.

Example

Food cooking durations

(see cooking tables in “Steam cooking”)

Parboiled rice	24 minutes
Rosefish fillet	6 minutes
Broccoli	4 minutes

Calculation of set cooking durations:

24 minutes minus

6 minutes = 18 minutes (1st cooking duration: rice)

6 minutes minus 4 minutes = 2 minutes (2nd cooking duration: rosefish fillet)

Remaining time = 4 minutes (3rd cooking duration: broccoli)

Cooking duration	24 min. – rice		
		6 min. – fish fillet	
			4 min. – broccoli
Settings	18 min.	2 min.	4 min.

Steam cooking

Cooking a whole menu

- Place the rice in the oven compartment first.
- Set the 1st cooking duration: 18 minutes.
- After the 18 minutes, place the fish into the appliance.
- Set the 2nd cooking duration: 2 minutes.
- After the 2 minutes, place the broccoli into the appliance.
- Set the 3rd cooking duration: 4 minutes.

Reheat

The steam oven is very effective at reheating food gently, without drying it out or cooking it further. The food will reheat evenly and does not need to be stirred during the reheating process.

You can reheat individual dishes or plated meals which have been prepared previously (e.g. meat, vegetables and potatoes).

Suitable containers

Small quantities can be reheated on a plate, larger quantities should be placed in a cooking container.

Time

The number of plates or containers has no bearing on the time.

The times listed in the table relate to an average portion per plate. Increase the duration for larger quantities.

Tips

- Do not reheat large items, such as a joint of roast meat, whole. Divide it into portions and reheat these as plated meals.
- Compact items, such as stuffed peppers, roulades or dumplings, should be cut in half.
- Reheat sauces separately. Exceptions are dishes such as goulash, which is cooked in sauce.
- Cover food when reheating it to avoid steam condensing on the crockery.
- Please note that breaded items, such as schnitzel, will not retain their crispness when they are reheated.

Heating food

- Cover the food being warmed up with a plate or foil that is resistant to temperatures up to 100 °C and to steam.
- Place the food on the rack or in a cooking container.

Settings

Steam cooking 
Temperature: 100 °C
Duration: see chart

Further applications

The durations specified in the table are guidelines only. We recommend selecting the shorter duration initially. You can increase the duration if necessary.

Food	🕒* [min]
Vegetables	
Carrots Cauliflower Kohlrabi Beans	6–7
Side dishes	
Pasta Rice	3–4
Potatoes, halved lengthways	12–14
Dumplings	15–17
Meat and poultry	
Sliced meat, 1.5 cm thick Roulades, sliced Goulash Lamb stew	5–6
Meatballs	13–15
Chicken escalopes Turkey escalopes	7–8
Fish	
Fish fillets, 2 cm thick	6–7
Fish fillets, 3 cm thick	7–8
Plated meals	
Spaghetti with tomato sauce	13–15
Roast pork, potatoes, vegetables	12–14
Stuffed pepper (halved), rice	13–15
Chicken fricassee, rice	7–8
Vegetable soup	2–3
Creamy soup	3–4

Further applications

Food	🕒* [min]
Consommé	2-3
Stew	4-5

🕒 Duration

* These times apply to food heated on a plate and covered with a plate.

Further applications

Defrost

It is much quicker to defrost food in the steam oven than at room temperature.

 Risk of infection from bacteria. Bacteria such as salmonella can cause life-threatening food poisoning.

It is particularly important to observe food hygiene rules when defrosting fish and meat, and in particular when defrosting poultry.

Do not use the liquid produced during defrosting.

Process the food as required as soon as it has been defrosted.

Temperature

60 °C is the best temperature for defrosting.

Exception: 50 °C for minced meat and game

Before and after defrosting

Remove any packaging before defrosting.

Exceptions: Leave bread, biscuits and cakes in their packaging as otherwise they will absorb moisture and become soft.

Allow food to stand at room temperature for a few minutes after defrosting. The standing time is necessary to allow the even distribution of heat from the outside to the inside.

Cooking containers

Use a perforated container with a glass or condensate tray underneath it when defrosting food which will drip, such as poultry. This way food will not be lying in defrosted liquid.

Food which does not drip can be defrosted in a solid container.

Tips

- Fish, for instance, does not need to be fully defrosted before cooking. Defrost so that the surface is sufficiently thawed to take herbs and seasoning. Depending on the thickness of the fish, 2–5 minutes is generally enough.
- When defrosting food which has frozen together, e.g. berries and meat portions, separate them half-way through the defrosting time.
- Do not refreeze food once it has thawed.
- Defrost frozen pre-cooked meals according to the instructions on the packaging.

Settings

Steam cooking 

Temperature: see chart

Defrosting duration: see chart

Standing time: see chart

Further applications

The durations specified in the table are guidelines only. We recommend selecting the shorter defrosting time initially. You can increase the defrosting time longer if necessary.

Frozen food	Quantity	🌡️ [°C]	🕒 [min]	⌚ [min]
Dairy products				
Sliced cheese	125 g	60	15	10
Quark	250 g	60	20–25	10–15
Cream	250 g	60	20–25	10–15
Soft cheese	100 g	60	15	10–15
Fruit				
Apple sauce	250 g	60	20–25	10–15
Apple chunks	250 g	60	20–25	10–15
Apricots	500 g	60	25–28	15–20
Strawberries	300 g	60	8–10	10–12
Raspberries/currants	300 g	60	8	10–12
Cherries	150 g	60	15	10–15
Peaches	500 g	60	25–28	15–20
Plums	250 g	60	20–25	10–15
Gooseberries	250 g	60	20–22	10–15
Vegetables				
Frozen in a block	300 g	60	20–25	10–15
Fish				
Fish fillets	400 g	60	15	10–15
Trout	500 g	60	15–18	10–15
Lobster	300 g	60	25–30	10–15
Small shrimps	300 g	60	4–6	5
Ready meals				
Meat, vegetables, side dishes/ stew/soup	480 g	60	20–25	10–15
Meat				
Roast meat, sliced	125–150 g each	60	8–10	15–20

Further applications

Frozen food	Quantity	🌡️ [°C]	⌚ [min]	⌛ [min]
Minced meat	250 g	50	15–20	10–15
	500 g	50	20–30	10–15
Goulash	500 g	60	30–40	10–15
	1000 g	60	50–60	10–15
Liver	250 g	60	20–25	10–15
Saddle of hare	500 g	50	30–40	10–15
Saddle of venison	1000 g	50	40–50	10–15
Cutlets/chops/sausages	800 g	60	25–35	15–20
Poultry				
Chicken	1000 g	60	40	15–20
Chicken thighs	150 g	60	20–25	10–15
Chicken escalopes	500 g	60	25–30	10–15
Turkey legs	500 g	60	40–45	10–15
Baked goods				
Puff pastries/yeast-dough pastry	–	60	10–12	10–15
Creamed mixture cakes/biscuits	400 g	60	15	10–15
Bread/rolls				
Bread rolls	–	60	30	2
Rye bread, sliced	250 g	60	40	15
Wholegrain bread, sliced	250 g	60	65	15
White bread, sliced	150 g	60	30	20

🌡️ Temperature ⌚ Defrosting time ⌛ Standing time

Blanching

Blanch vegetables before freezing them. Blanching helps maintain the quality of the produce when it is frozen.

Blanching vegetables also helps them retain their original colour.

- Put the prepared vegetables into a perforated cooking container.
- Once blanched, plunge the vegetables into ice cold water to cool them down quickly. Drain them well.

Settings

Steam cooking 
Temperature: 100 °C
Duration: 1 minute

Bottling

Only use unblemished, fresh produce which is in good condition for bottling.

Glass jars

Use clean glass jars and accessories and check them for any defects. Glass jars with twist off lids or glass lids with a rubber seal are suitable.

Make sure that all the jars are the same size so that bottling is carried out evenly.

After you have filled the jars with the bottled produce, clean the glass rims with a clean cloth and hot water and then seal the jars.

Fruit

Sort fruit carefully, rinse it briefly but thoroughly and allow it to drain. Take great care when cleaning soft fruit as it is very delicate and squashes easily.

Remove any peel, stalks, cores or stones. Cut up large fruit. For example, cut apples into slices.

If you are bottling fruit with stones (e.g. plums, apricots) without removing the stones, pierce the fruit several times with a fork or wooden skewer as otherwise it will burst.

Further applications

Vegetables

Rinse, clean and cut up vegetables.

Vegetables should be blanched before bottling to help them retain their colour (see “Special applications” – “Blanching”).

Fill volume

Fill the glass jars with produce up to a maximum of 3 cm below the rim. Do not pack it down as this will damage the cell walls of the produce. Tap the jar gently onto a cloth to help distribute the contents evenly. Fill the jars with liquid. The produce must be completely covered.

Use a sugar solution for fruit and a salt or vinegar solution for vegetables.

Tips

- Make use of residual heat by leaving the jars in the oven for 30 minutes after it has switched off.
- Then cover the jars with a cloth and allow to cool for approx. 24 hours.

Bottling food

- Place the rack in shelf level 1.
- Place the jars on the rack. The jars must not touch each other.

Settings

Steam cooking 

Temperature: see chart

Duration: see chart

Further applications

Food to be bottled	🌡️ [°C]	🕒* [min]
Berries		
Currants	80	50
Gooseberries	80	55
Cranberries	80	55
Fruit with stones		
Cherries	85	55
Mirabelle plums	85	55
Plums	85	55
Peaches	85	55
Greengages	85	55
Fruit with pips		
Apples	90	50
Apple sauce	90	65
Quinces	90	65
Vegetables		
Beans	100	120
Broad beans	100	120
Gherkins	90	55
Beetroot	100	60

🌡️ Temperature 🕒 Duration

* Bottling times apply to 1.0 l jars. If using 0.5 l jars, reduce the duration by 15 minutes. If using 0.25 l jars, reduce the duration by 20 minutes.

Further applications

Disinfect items

The steam oven can be used to disinfect baby bottles and other containers so that at the end of the programme they are as germ free as they would have been had they been boiled. Check beforehand that all parts, teats etc. are declared by the manufacturer to be heat resistant to 100 °C and also that they can withstand hot steam.

Dismantle, clean and thoroughly rinse baby bottles. All parts of the bottles must be completely dry before they are reassembled to keep them germ free.

- Place the individual items on the rack or in a perforated container (on their sides or with the opening facing downwards) ensuring that they do not touch one another to allow hot steam to reach them from all sides.

Settings

Steam cooking SSS
Temperature: 100 °C
Duration: 15 minutes

Prove dough

- Prepare the dough according to the recipe.
- Place the dough, uncovered, in a bowl on the rack.

Settings

Steam cooking SSS
Temperature: 40 °C
Duration: as per recipe instructions

Heating damp flannels

- Moisten the flannels and then roll them up.
- Place them beside one another in a perforated cooking container.

Settings

Steam cooking 

Temperature: 70 °C

Duration: 2 minutes

Dissolve gelatine

- Soften **gelatine leaves** by leaving them in a bowl of cold water for 5 minutes. The gelatine leaves have to be fully covered with water. Remove the gelatine leaves from the bowl and squeeze them out. Empty the bowl. Place the squeezed gelatine leaves back in the bowl.
- Place **gelatine powder** in a bowl and add water according to the instructions on the packaging.
- Cover the bowl and place on the rack.

Settings

Steam cooking 

Temperature: 90 °C

Duration: 1 minute

Further applications

Decrystallise honey

- Loosen the lid and place the jar of honey in a perforated container.
- Stir the honey once during the cooking duration.

Settings

Steam cooking SSS

Temperature: 60 °C

Duration: 90 minutes (irrespective of the size of jar or the amount of honey in the jar)

Melt chocolate

You can use the steam oven for melting any type of chocolate.

When using a cake covering, place it in a perforated cooking container, leaving it in its packaging.

- Break the chocolate into small pieces.
- Place larger quantities in a solid cooking container and smaller quantities in a cup or a bowl.
- Cover the container or the dish with a lid or with foil that is resistant to temperatures up to 100 °C and to hot steam.
- Stir large quantities once halfway through cooking.

Settings

Steam cooking SSS

Temperature: 65 °C

Duration: 20 minutes

Make yoghurt

To make yoghurt, you will need either fresh live yoghurt or yoghurt culture, obtainable from health food shops.

Use natural yoghurt with live culture and without additives. Heat-treated yoghurt is not suitable.

The yoghurt must be fresh (short storage time).

You can use either unchilled long-life milk or fresh milk.

Long-life milk can be used as it is – no further preparation is required. Fresh milk must first be heated to 90 °C (do not boil it) and then cooled down to 35 °C. Fresh milk will give a better set than long-life milk.

The yoghurt and milk should have the same percentage fat.

Do not move or shake the jars whilst the yoghurt is thickening.

Immediately after preparation, leave the yoghurt to cool in the fridge.

How well home-prepared yoghurt sets will depend on the consistency, fat content and the cultures used in the starter yoghurt. Not all yoghurts are suitable for use as starter yoghurt.

Tip: When using yoghurt enzyme, yoghurt can be made from a milk / cream mixture. Mix $\frac{3}{4}$ litre milk with $\frac{1}{4}$ litre cream.

- Mix 100 g yoghurt with 1 l milk or make up the mixture with yoghurt enzyme, following the instructions on the packaging.
- Pour the mixture into jars and seal the jars.
- Place the sealed jars into a perforated cooking container or on the rack. The jars must not touch each other.
- Straight after the cooking duration has finished, place the jars in the refrigerator. Take care not to shake the jars unnecessarily.

Settings

Steam cooking SSS

Temperature: 40 °C

Duration: 5:00 hours

Possible reasons for unsatisfactory results

Yoghurt has not set:

Incorrect storage of starter yoghurt, too much time out of the refrigerator, e.g. in transportation, damaged packaging, milk not sufficiently heated.

Liquid has separated:

The jars were moved, yoghurt was not cooled down quickly enough.

Yoghurt is gritty:

Milk was overheated or in poor condition, milk and starter yoghurt not evenly stirred.

Further applications

Cook bacon

The bacon does not brown.

- Place the bacon (diced or rashers) in a solid cooking container.
- Cover the container with foil that is temperature-resistant up to 100 °C and resistant to steam.

Settings

Steam cooking 
Temperature: 100 °C
Duration: 4 minutes

Sweat onions

Sweating means cooking the onions in their own juices, with the addition of a little fat if necessary.

- Cut the onions up into small pieces and place them in a solid cooking container with a little butter.
- Cover the container with foil that is temperature-resistant up to 100 °C and resistant to steam.

Settings

Steam cooking 
Temperature: 100 °C
Duration: 4 minutes

Extracting juice with steam

This appliance is ideal for extracting juice from soft, firm and hard fruit.

It is best to use overripe fruit, as the riper the fruit, the greater the quantity of juice produced. Very ripe fruit will also produce a more intense flavour.

Preparation

Sort and clean the fruit. Cut out any blemishes.

Remove the stalks from grapes and morello cherries as these are bitter. Berries do not need to have their stalks removed.

Cut larger fruit such as apples into chunks of approximately 2 cm in size. The harder the fruit, the smaller the pieces should be.

Tips

- Try experimenting with mild and tart fruit.
- Adding sugar will increase the quantity of juice produced and improve the flavour. Sprinkle the fruit with sugar and leave to absorb for a few hours before juicing. For 1 kg of sweet fruit add 50–100 g of sugar, and for 1 kg of tart fruit add 100–150 g of sugar.
- If you wish to bottle the juice rather than consume it straight away, pour it whilst hot into hot, sterilised bottles, and then seal immediately with sterilised tops.

Extracting juice from fruit

- Put the prepared fruit into a perforated cooking container.
- Place a solid container or a glass or condensate tray (depending on the model) underneath to catch the juice.

Settings

Steam cooking 

Temperature: 100 °C

Duration: 40–70 minutes

Further applications

Skinning vegetables and fruit

- Cut a cross in the top of tomatoes, nectarines, etc. This will allow the skin to be removed more easily.
- Place the fruit/vegetables in a perforated cooking container.
- To blanch almonds, it is important to plunge them into cold water as soon as they are taken out of the oven, otherwise the skin cannot be removed.

Settings

Steam cooking 
Temperature: 100 °C
Duration: see chart

Food	 [min]
Apricots	1
Almonds	1
Nectarines	1
Peppers	4
Peaches	1
Tomatoes	1

 Duration

Apple storage

You can treat homegrown apples in the steam oven to increase the length of time for which you can store them. Once treated, the apples will keep for 5 to 6 months when stored in a dry, cool and well-ventilated place. This method is only suitable for apples and not for other types of fruit.

Settings

Steam cooking 
Temperature: 50 °C
Duration: 5 minutes

Making eierstich



- Mix 6 eggs with 375 ml milk (do not beat into a foam).
- Season the egg and milk mixture and pour into a solid cooking container greased with a little butter.

Settings

Steam cooking 
Temperature: 100 °C
Duration: 4 minutes

Note for test institutes



Test food in accordance with EN 60350-1 (steam cooking)

Test food	Cooking containers	Quantity [g]	 ⁴ ₁	 ² [°C]	 [min]
Steam replenishment					
Broccoli (8.1)	1 x DGGL 1/2–40 L	300	Any	100	3
Steam distribution					
Broccoli (8.2)	2 x DGGL 1/2–40 L	Max.	Any ³	100	3
Appliance capacity					
Peas (8.3)	4 x DGGL 1/2–40 L	875 in each	2, 4 ⁴	100	5

⁴₁ Shelf level(s), ² Temperature,  Cooking duration

- Place the condensate tray on shelf level 1.
- Place the test food in the cold oven compartment (before the heating-up phase begins).
- Place the 2 x DGGL 1/2–40 L on the shelf indicated.
- Place the 2 x DGGL 1/2–40 L on each of the shelves indicated.
- The test is finished when the temperature measures 85 °C in the coolest place.

Menu cooking test food¹ (steam cooking)

Test food	Cooking containers	Quantity [g]	 ⁴ ₁	 [°C]	Height [cm]	 [min]
Potatoes, waxy, quartered ³	1 x 1/2 DGGL–40 L	800	4	100	–	17
Salmon fillet, frozen, not defrosted	1 x 1/2 DGGL–40 L	4 x 150	2	100	< 2.5 ≥ 2.5 ≤ 3.2 > 3.2	9 10 11
Broccoli, florets	1 x 1/2 DGGL–40 L	600	3	100	–	4

⁴₁ Shelf level, ² Temperature,  Cooking duration

- For instructions, see “Steam cooking – Menu cooking”.
- Place the condensate tray on shelf level 1.
- Place the 1st test food item (potatoes) in the cold oven compartment (before the heating-up phase begins).

Cleaning and care

 Risk of injury caused by hot surfaces.

The steam oven gets hot during operation. You could burn yourself on the oven compartment, side runners or accessories.

Allow the oven compartment, side runners and accessories to cool before cleaning.

 Risk of injury due to electric shock.

The steam from a steam cleaning appliance could reach live electrical components and cause a short circuit.

Never use a steam cleaner for cleaning.

Surfaces can discolour or alter if unsuitable cleaning agents are used. All surfaces are susceptible to scratching. Scratches on glass can in some circumstances lead to breakage.

Use only domestic washing-up liquid to clean the appliance.

Remove all cleaning agent residues immediately.

Do not use cleaning agents or washing-up liquids containing aliphatic hydrocarbons as these could cause the seals to swell.

If soiling is left on for any length of time, it may become impossible to remove.

Surfaces may suffer discolouration or damage.

It is therefore best to remove any soiling immediately.

- The appliance and accessories should be cleaned and dried thoroughly after each use.
- Leave the appliance door open until the oven compartment is completely dry.

Tip: If the appliance is not going to be used for a longer period of time – during a holiday, for example – it should be thoroughly cleaned and dried beforehand to prevent the build-up of odours and so on. Leave the door open afterwards.

Unsuitable cleaning agents

To avoid damaging the surfaces of your appliance, do not use:

- Cleaning agents containing soda, ammonia, acids or chlorides
- Cleaning agents containing descaling agents
- Abrasive cleaning agents, e.g. powder cleaners and cream cleaners
- Solvent-based cleaning agents
- Stainless steel cleaning agents
- Dishwasher cleaner
- Glass cleaning agents
- Cleaning agents for ceramic glass hobs
- Hard, abrasive brushes or sponges (e.g. pot scourers, brushes or sponges which have been previously used with abrasive cleaning agents)
- Melamine eraser blocks
- Sharp metal scrapers
- Wire wool
- Stainless steel spiral pads
- Spot cleaning with mechanical cleaning agents
- Oven cleaners or sprays

Cleaning the steam oven front

- Clean the appliance front with a clean, soft sponge and a solution of warm water and washing-up liquid.
- After cleaning, wipe the surfaces dry using a soft cloth.

Tip: A clean, damp microfibre cloth without cleaning agent can also be used.

Cleaning and care

Cleaning the oven compartment

The oven compartment, the door seal, the drip channel and the inside of the door should be cleaned and dried after each use.

- Remove:
 - condensate using a sponge or absorbent cloth
 - light, greasy soiling with a clean sponge and a solution of washing-up liquid and hot water.
- After cleaning, wipe the surface with clean water to remove any cleaning agent residues.
- Then wipe the surfaces dry using a cloth.

After prolonged use, the **floor heater** can become discoloured by drops of liquid, but this does not impair the function.

The **door seal** is designed to last the lifetime of the appliance. Should it for any reason need replacing, please contact the Customer Service Department (see the end of these operating instructions).

Cleaning the automatic door opener

Ensure that the door opener does not become soiled with food residues.

- Wipe away soiling **immediately** with a clean sponge and a solution of washing-up liquid and hot water.
- After cleaning, wipe the surface with clean water to remove any cleaning agent residues.

Cleaning the water container

- Remove the water container after each use.
- Remove the spill guard.
- Empty the water container.
- Rinse the water container by hand and then dry it to prevent limescale.
- Push the spill guard back onto the water container. Make sure the spill guard engages correctly.

Accessories

All accessories are dishwasher safe.

Cleaning the condensate tray, rack and cooking containers

- Wash and dry the condensate tray, rack and cooking containers after each use.
- Any bluish discolouration on the cooking containers can be removed with vinegar. Then rinse with clean water.

Cleaning and care

Cleaning the side runners

The side runners are suitable for cleaning in a dishwasher.

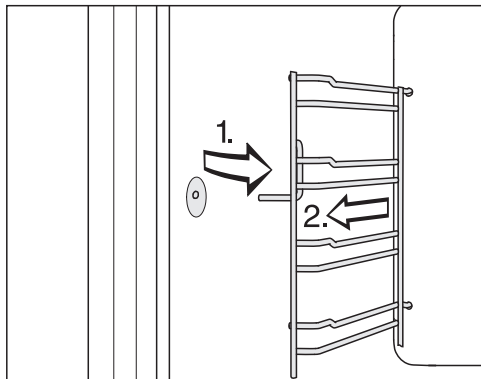

- Pull the side runners out of holder (1.) and remove them (2.).
- The side runners can be washed in the dishwasher or by hand with a solution of warm water and a little washing-up liquid applied with a clean sponge or cloth.

Reassemble by following these instructions in reverse order.

- Carefully refit the side runners.

If the side runners are not correctly inserted, there is no anti-tip protection.

Descaling the steam oven

We recommend using Miele descaling tablets (see “Optional accessories”) to descale the appliance. These have been specially developed for use with Miele appliances to optimise the descaling process. Other descaling agents, which contain other acids besides citric acid and/or other undesirable substances, such as chlorides for example, could cause damage to the product. Moreover, the descaling result required could not be guaranteed if the descaling solution was not of the appropriate concentration.

Do not spill descaling agent onto metal surfaces. This can cause marks to appear.

However, should any descaling agent get onto these surfaces, wipe it away immediately.



The steam oven has to be descaled after a certain number of operating hours. When it needs descaling, the  symbol and a number will appear when the steam oven is switched on. The number indicates the number of times that the steam oven can be used before it has to be descaled:



The steam oven will lock after the last remaining cooking process.

We recommend that you descale the appliance before it locks out.

During the descaling process, the water container must be rinsed out and re-filled with fresh water.

- Touch the On/Off sensor ① until the flashing  symbol and the descaling time appear.
- Fill the water container with lukewarm fresh tap water up to the level marker  and drop 2 Miele descaling tablets in it.
- Wait until the descaling tablets have dissolved.
- Push the water container into the appliance.
- Confirm with *OK*.

The descaling process will now begin.

Do not switch the steam oven off during the descaling process, otherwise the whole process will have to be started from the beginning again.

During the descaling process, the water container must be rinsed out and re-filled **twice** with fresh water. At this point, a buzzer will sound and the  symbol will appear.

- Remove the water container and remove the spill guard.
- Empty the water container and rinse it thoroughly.
- Fill the water container up to the level marker  and push it into the appliance.
- Confirm with *OK*.

The  symbol will go out. Descaling will continue.

After you have rinsed the water container a second time and filled it with fresh tap water, a buzzer will sound a few minutes later. The descaling process is complete.

- Switch the steam oven off.
- Remove the water container and take out the spill guard.
- Empty and dry the water container.
- Allow the oven compartment to cool down.
- Then dry the oven compartment.
- Leave the appliance door open until the oven compartment is completely dry.



Problem solving guide

Many malfunctions and faults that can occur in daily operation can be easily remedied. Time and money will be saved because a service call will not be needed.

The following guide may help you to find the reason for a malfunction or a fault, and to correct it.

Problem	Cause and remedy
<p>You cannot switch the appliance on.</p>	<p>The fuse has tripped.</p> <ul style="list-style-type: none"> ■ Reset the trip switch in the fuse box or replace the fuse in the plug (see data plate for minimum fuse rating). <p>There may be a technical fault.</p> <ul style="list-style-type: none"> ■ Disconnect the appliance from the mains connection for approximately 1 minute by: <ul style="list-style-type: none"> – Tripping the relevant mains fuse or unscrewing the fuse completely, or – Switching off the residual current protection device ■ If, after resetting the trip switch in the mains fuse box or the residual current protection device, the steam oven will still not turn on, contact a qualified electrician or Miele Service.
<p>The oven compartment does not heat up.</p>	<p>Demo mode is active. <i>nES_</i> appears. The steam oven can be operated, however, the heating elements will not work.</p> <ul style="list-style-type: none"> ■ Deactivate demo mode (see “Settings”). <p>The oven compartment has been warmed up by a warming drawer in operation underneath it.</p> <ul style="list-style-type: none"> ■ Open the door and let the oven compartment cool down.
<p>The fan can still be heard after the appliance has been switched off.</p>	<p>The fan is still running. The appliance is fitted with a fan which removes steam from the oven. The fan will continue to run for a while after the appliance has been switched off. It will switch itself off automatically after a while.</p>

Problem solving guide

Problem	Cause and remedy
A humming sound can be heard after switching on the appliance, during operation and after switching off the appliance.	It is quite normal and does not indicate any fault with the appliance. It happens when water is being pumped through the system.
After moving house, the steam oven no longer switches from the heating-up phase to the cooking phase.	The boiling temperature of the water has changed as the altitude of the new location for the appliance differs from the old one by at least 300 m. <ul style="list-style-type: none"> ■ To adjust the boiling temperature, you need to descale the steam oven (see “Cleaning and care – Descaling the steam oven”).
During operation an unusually large amount of steam escapes, or steam escapes from parts of the oven where it does not usually.	The door is not properly closed. <ul style="list-style-type: none"> ■ Close the door.
	The door seal is not correctly fitted. <ul style="list-style-type: none"> ■ Press it in all the way round the door to make sure it is fitted evenly.
	The door seal is damaged, e.g. cracks can be seen. <ul style="list-style-type: none"> ■ Call Miele Service.
A whistling sound is heard when the appliance is switched on again.	When the door is closed, the pressure has to equalise, which can cause a whistling sound. This is not a fault.
The  symbol appears in the display and an audible tone may sound.	The water container has not been pushed into the appliance properly. <ul style="list-style-type: none"> ■ Remove the water container and push it back in so that it connects.
	There is not enough water in the water container. The water level must be between the two marks. <ul style="list-style-type: none"> ■ Fill the water container
The  symbol and a number between 1 and 10 appear. The descaling time and  flash.	The appliance needs to be descaled. <ul style="list-style-type: none"> ■ Descal the steam oven (see “Cleaning and care – Descaling the steam oven”).

Problem solving guide

Problem	Cause and remedy
<i>F44</i>	Communication fault <ul style="list-style-type: none">■ Switch the steam oven off and then back on again after a few minutes.■ If the same message appears again, call the Service Department.
<i>F</i> and other fault codes	Technical fault. <ul style="list-style-type: none">■ Switch the appliance off and contact Miele.

Miele offer a comprehensive range of useful accessories as well as cleaning and conditioning products for your Miele appliances.

These products can be ordered through the Miele Webshop.

They can also be ordered from Miele (see end of this booklet for contact details) or from your Miele dealer.

Containers

Miele offers a wide range of containers. Their dimensions and functions are tailored perfectly to Miele appliances. Detailed information on the individual products is available on the Miele website.

- Perforated cooking containers in various sizes
- Solid cooking containers in various sizes

Cleaning and care products

- Descaling tablets (6)
- All-purpose microfibre cloth for removing finger marks and light soiling

Service

Contact in case of malfunction

In the event of any faults which you cannot remedy yourself, please contact your Miele Dealer or Miele Service.

Contact information for Miele Service can be found at the end of this document.

Please note that telephone calls may be monitored and recorded for training purposes and that a call-out charge will be applied to service visits where the problem could have been resolved as described in this booklet.

Please quote the model and serial number of your appliance when contacting Miele. This information can be found on the data plate.

This information is given on the data plate, which is visible on the front frame of the oven when the door is fully open.

Warranty

For information on the appliance warranty specific to your country please contact Miele. See back cover for address.

In the UK, your appliance warranty is valid for 2 years from the date of purchase. However, you must activate your cover by calling 0330 160 6640 or registering online at www.miele.co.uk.

Safety instructions for installation

 Risk of damage from incorrect installation.
Incorrect installation can cause damage to the steam oven.
The steam oven must only be installed by a qualified person.

▶ The connection data (frequency and voltage) on the steam oven's data plate absolutely must correspond with those of the electricity supply in order to ensure that no damage can occur to the steam oven.

Compare this data before connecting the appliance. If in any doubt, consult a qualified electrician.

▶ Multi-socket adapters and extension leads do not guarantee the required safety of the appliance (fire hazard). Do not use them to connect the steam oven to the power supply.

▶ The socket should be easily accessible after the steam oven has been installed.

▶ The steam oven must be positioned so that you can see the contents of a cooking container placed on the top shelf level. Otherwise there is a risk of injuries or spillages of hot food.

Installation

Building-in dimensions

All dimensions are given in mm.

Installation in a tall unit

The furniture housing unit must not have a back panel fitted behind the building-in niche.

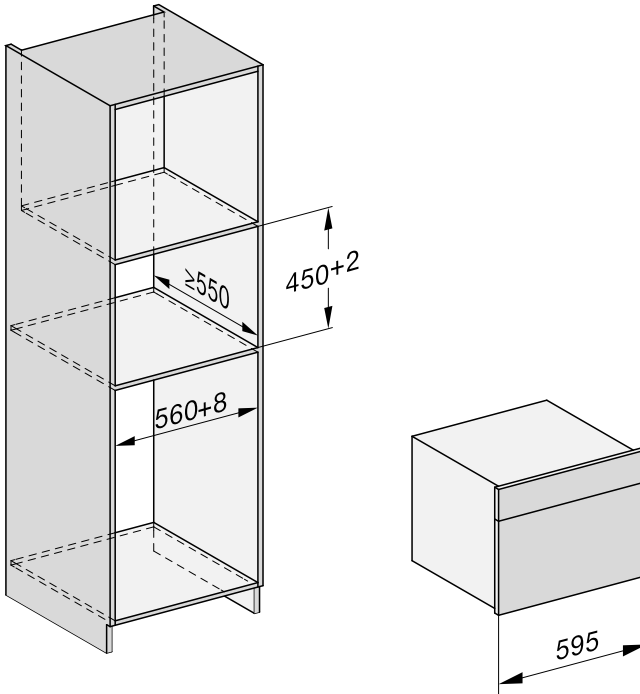

Installation in a base unit

The furniture housing unit must not have a back panel fitted behind the building-in niche.

When building the steam oven into a base unit underneath an electric or induction hob, please also observe the installation instructions for the hob as well as the building-in depth required for the hob.

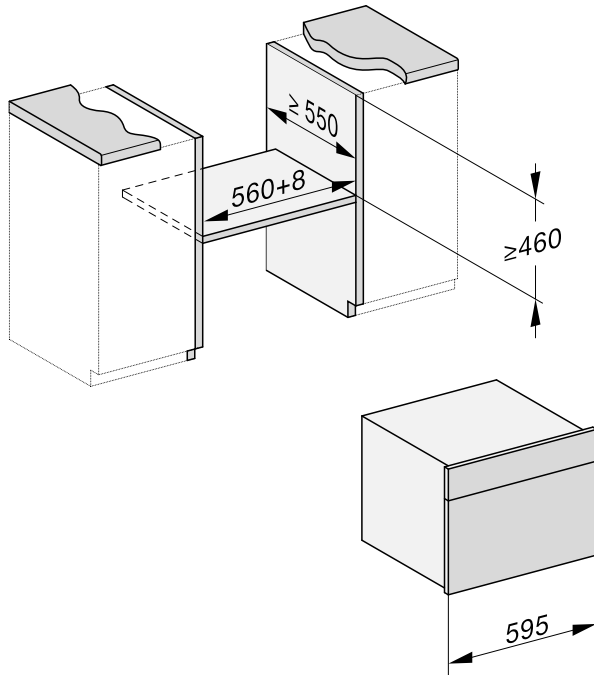

Installation

Side view

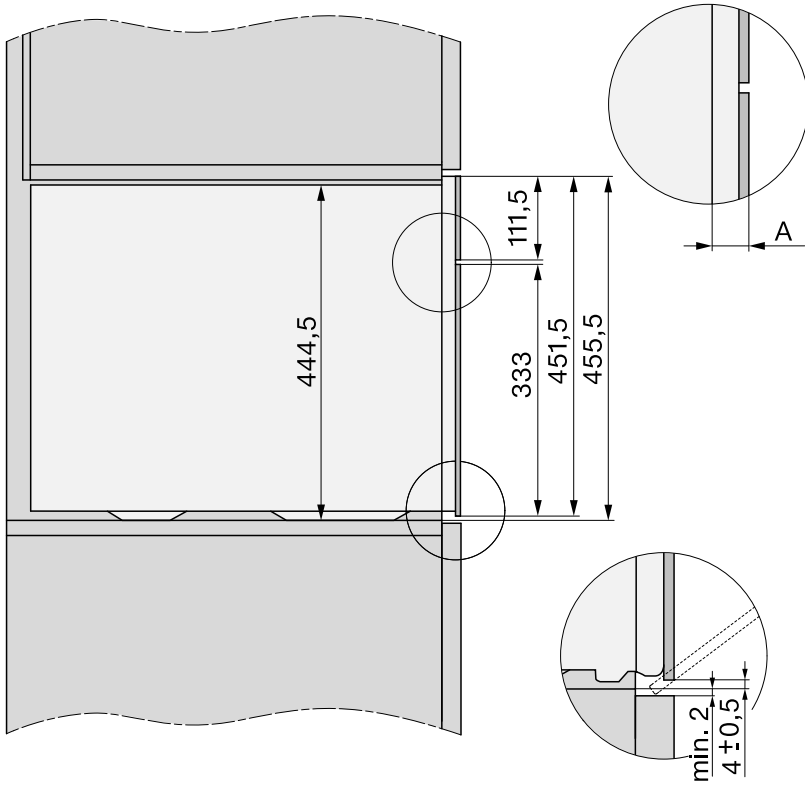

- A** Glass front: 22 mm
- Metal front: 23.3 mm

Connection and ventilation

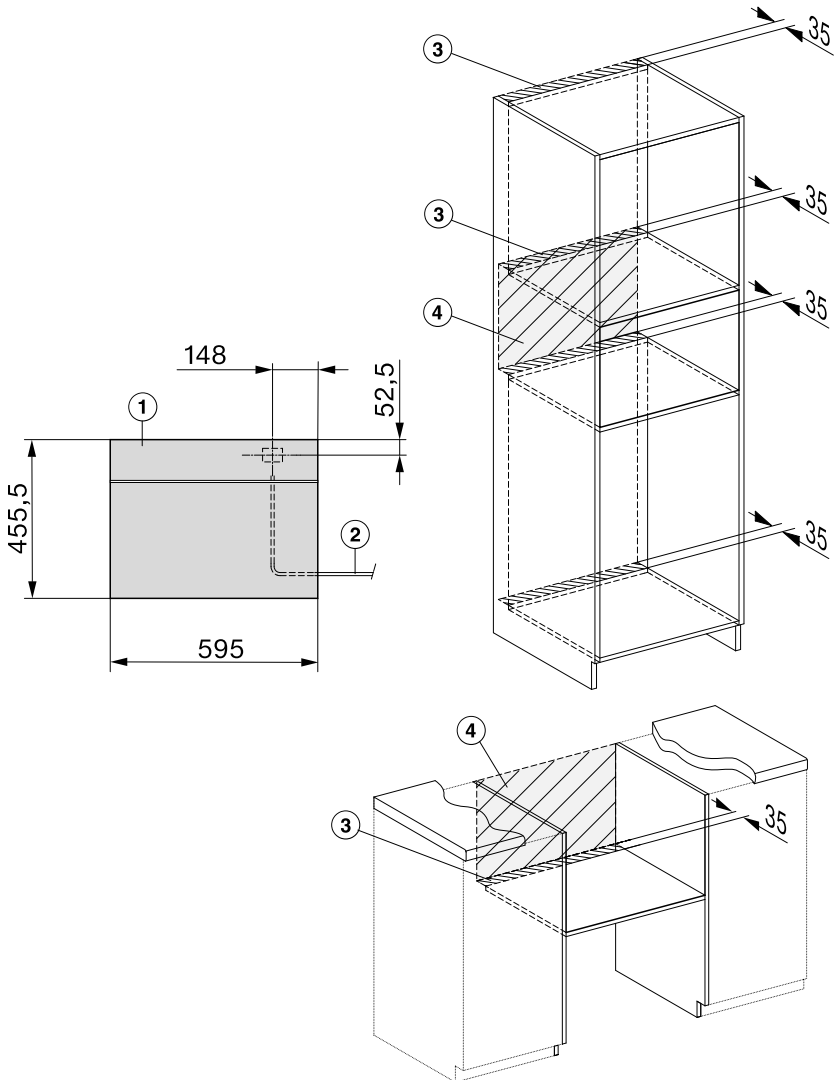

- ① View from the front
- ② Power cable, L = 2000 mm
- ③ Ventilation cut-out, min. 180 cm²
- ④ No connections permitted in this area

Installation

Installing the steam oven

- Connect the mains cable to the steam oven.

Risk of damage from incorrect transportation.

Lifting the steam oven by the door handle could cause damage to the door.

Use the handle cut-outs on the side of the casing to lift the appliance.

The steam generator may malfunction if the steam oven is not on a level surface.

The maximum deviation from the horizontal that can be tolerated is 2°.

- Push the steam oven into the housing unit and align it.
When doing so make sure that the power cable does not get trapped or damaged.
- Open the door.

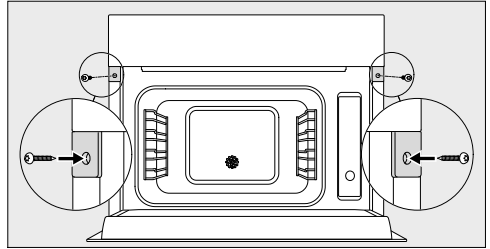

- Secure the steam oven to the side walls of the unit using the wood screws supplied (3.5 x 25 mm).
- Connect the steam oven to the electricity supply.
- Check all functions of the steam oven are working correctly in accordance with the operating instructions.

Electrical connection

We recommend that you connect the steam oven to the power supply using a suitable switched electrical socket. This makes it easier to perform servicing work. The socket must be easily accessible after the steam oven has been installed.

 Risk of damage from incorrect connection.

Installation, repairs and other maintenance work by unqualified persons could be dangerous. Miele cannot be held liable for unauthorised work. Miele cannot be held liable for damage or injury caused by the lack of or inadequacy of an on-site earthing system (e.g. electric shock).

If the plug is removed from the connection cable or if the cable is supplied without a plug, the steam oven must be connected to the electrical supply by a suitably qualified electrician.

If the socket is no longer accessible, or if a hard-wired connection is installed, an additional means of disconnection must be provided for all poles. A suitable means of disconnection would include switches with an all-pole contact gap of at least 3 mm. These include circuit breakers, fuses and contactors. The required connection data is provided on the data plate. Please ensure that these details match the electrical supply.

After installation, ensure that all electrical components are shielded and cannot be accessed by users.

Total power rating

See data plate

Connection data

The connection data is quoted on the data plate. Please ensure these match the household mains supply.

Residual current device

For extra safety, it is advisable to protect the steam oven with a suitable residual current device (RCD) with a trip range of 30 mA.

Replacing the mains connection cable

When replacing the mains connection cable, please use cable type H 05 VV-F with a suitable cross-section. These cables are available from the manufacturer or from Miele Service.

Installation

Disconnecting from the mains

 Risk of electric shock from mains voltage.

There is a risk of electric shock if the appliance is reconnected to the mains supply during repair or service work.

After disconnection, ensure the appliance cannot be switched back on by mistake.

To disconnect the appliance from the mains power supply, do one of the following depending on installation:

Safety fuses

- Completely remove the fuse links from the screw caps.

Automatic circuit breakers

- Press the test button (red) until the middle button (black) springs out.

Built-in circuit breakers

- For circuit breakers of at least type B or C, switch the lever from 1 (on) to 0 (off).

Residual current device (RCD)

- Residual current device: switch the main switch from 1 (on) to 0 (off) or press the test button.



United Kingdom

Miele Co. Ltd.
Fairacres, Marcham Road
Abingdon, Oxon, OX14 1TW
Tel: 0330 160 6600
Internet: www.miele.com

Australia

Miele Australia Pty. Ltd.
ACN 005 635 398
ABN 96 005 635 398
1 Gilbert Park Drive
Knoxfield, VIC 3180
Tel: 1300 464 353
Internet: www.miele.com.au

China

Miele (Shanghai) Trading Ltd.
1-3 Floor, No. 82 Shi Men Yi Road
Jing' an District
200040 Shanghai, PRC
Tel: +86 21 6157 3500
Fax: +86 21 6157 3511
E-mail: info@miele.cn
Internet: www.miele.cn

Miele (Hong Kong) Limited

41/F - 4101, Manhattan Place
23 Wang Tai Road
Kowloon Bay, Hong Kong
Tel: (852) 2610 1025
Fax: (852) 3579 1404
Email:
customerservices@miele.com.hk
Website: www.miele.hk

India

Miele India Pvt. Ltd.
Ground Floor
Copia Corporate Suites
Plot No. 9, Jasola
New Delhi - 110025
Tel: 011-46 900 000
Fax: 011-46 900 001
E-mail: customercare@miele.in
Internet: www.miele.in

Ireland

Miele Ireland Ltd.
2024 Bianconi Avenue
Citywest Business Campus
Dublin 24
Tel: (01) 461 07 10
Fax: (01) 461 07 97
E-Mail: info@miele.ie
Internet: www.miele.ie

Malaysia

Miele Sdn Bhd
Suite 12-2, Level 12
Menara Sapura Kencana
Petroleum
Solaris Dutamas No. 1
Jalan Dutamas 1
50480 Kuala Lumpur, Malaysia
Phone: +603-6209-0288
Fax: +603-6205-3768

New Zealand

Miele New Zealand Limited
IRD 98 463 631
Level 2, 10 College Hill
Freemans Bay, Auckland 1011
New Zealand
Tel: 0800 464 353
Internet: www.miele.co.nz

Singapore

Miele Pte. Ltd.
163 Penang Road
04 - 03 Winsland House II
Singapore 238463
Tel: +65 6735 1191
Fax: +65 6735 1161
E-Mail: info@miele.com.sg
Internet: www.miele.sg

South Africa

Miele (Pty) Ltd
63 Peter Place, Bryanston 2194
P.O. Box 69434, Bryanston 2021
Tel: (011) 875 9000
Fax: (011) 875 9035
E-mail: info@miele.co.za
Internet: www.miele.co.za

Taiwan

K.E. & Kingstone Co., Ltd.
6th Fl., No. 120, Sec. 2
Jianguo N. Rd.
Taipei, Taiwan
TEL: +886 2 2502-7256
FAX: +886 2 2502-3077
E-mail: kenk@kenk.com.tw
Website:
www.kenk.com.tw/ke/miele

Thailand

BHIRAJ TOWER at EmQuartier
43rd Floor Unit 4301-4303
689 Sukhumvit Road
North Klontong Sub-District
Vadhana District
Bangkok 10110, Thailand

United Arab Emirates

Miele Appliances Ltd.
Gold & Diamond Park
Office No. 6-217
Sheikh Zayed Road
P.O. Box 11 47 82 - Dubai
Tel. +971 4 3044 999
Fax. +971 4 3418 852
800-MIELE (64353)
E-Mail: info@miele.ae
Website: www.miele.ae

Manufacturer: Miele & Cie. KG, Carl-Miele-Straße 29, 33332 Gütersloh, Germany

DG2740, DG2840

en-GB

M.-Nr. 11 244 810 / 00